

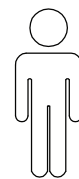

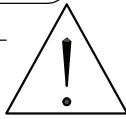

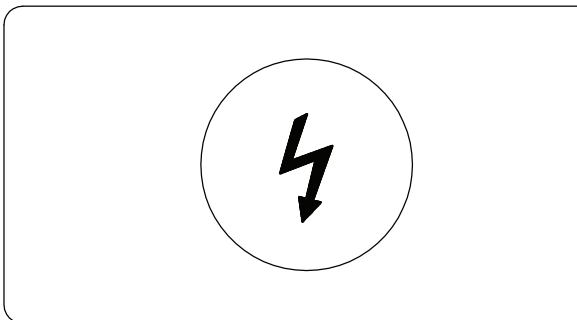

20'

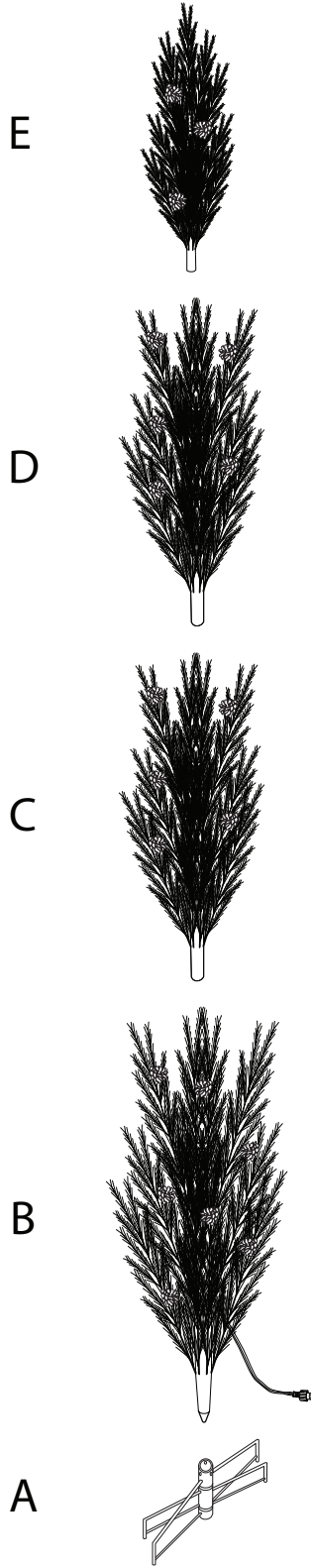
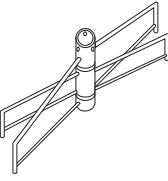

1

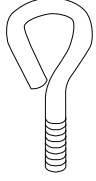

<p><b>A</b></p>  <p><b>x 1</b></p>	<p><b>B</b></p>  <p><b>x 1</b></p>	<p><b>C</b></p>  <p><b>x 1</b></p>	<p><b>D</b></p>  <p><b>x 1</b></p>	<p><b>E</b></p>  <p><b>x 1</b></p>	<p><b>F</b></p>  <p><b>x 3</b></p>	<p><b>G</b></p>  <p><b>x 1</b></p>
---	---	---	---	--	---	---

1

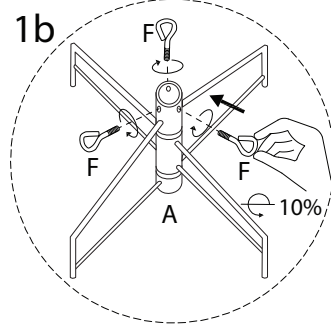
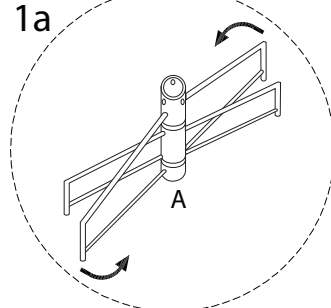
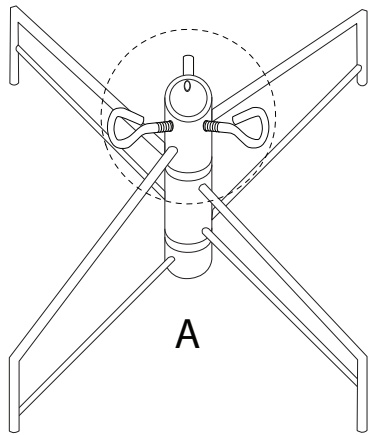
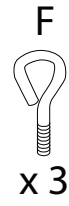
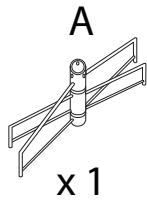

2

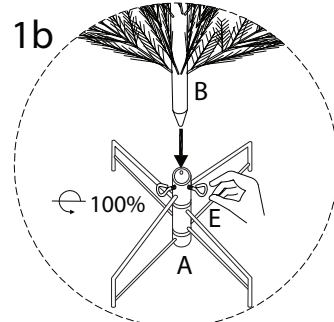
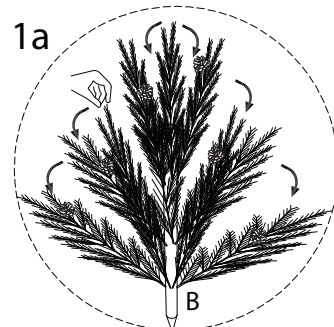
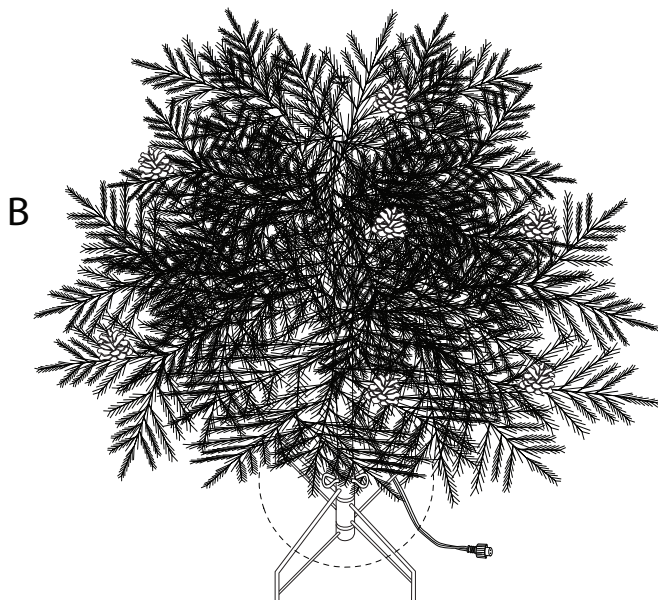

3

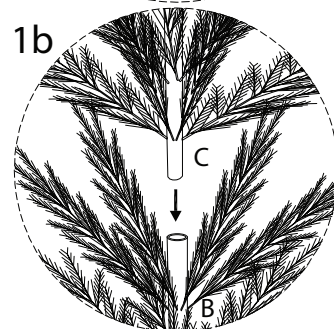
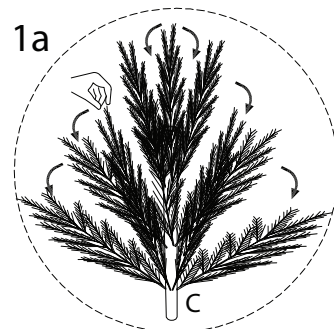
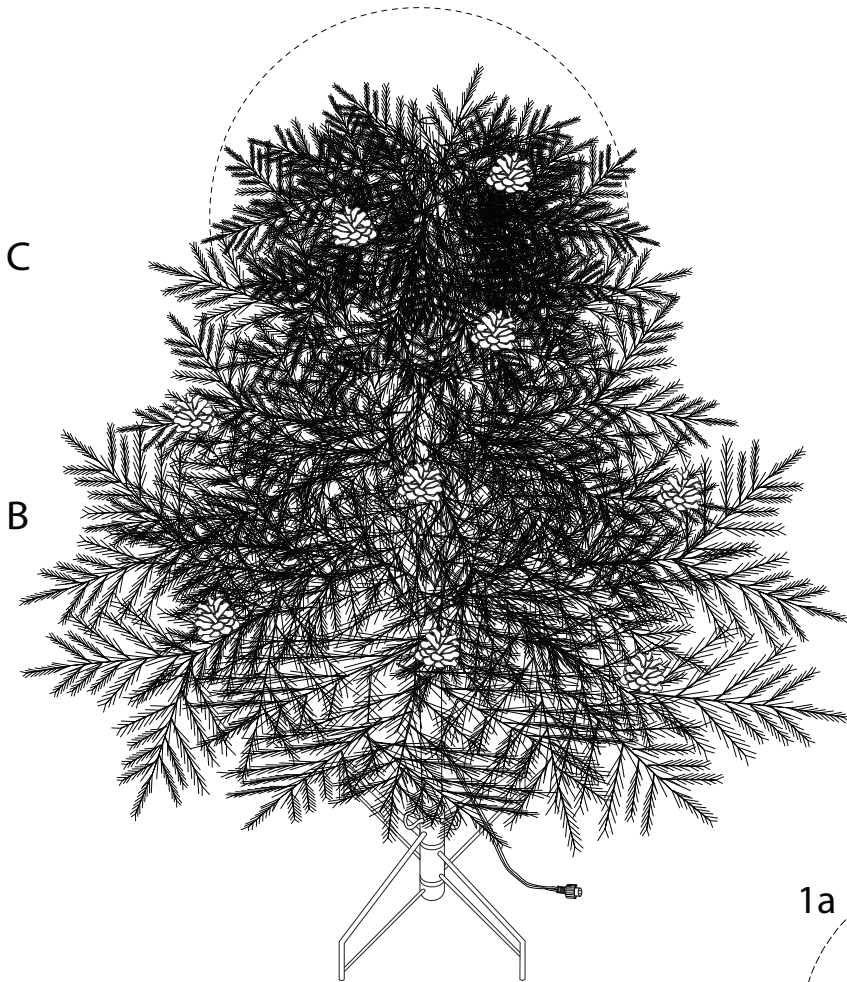

4

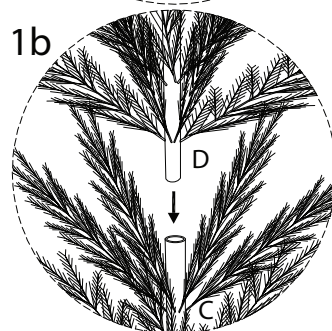
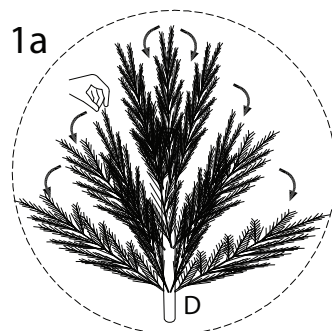
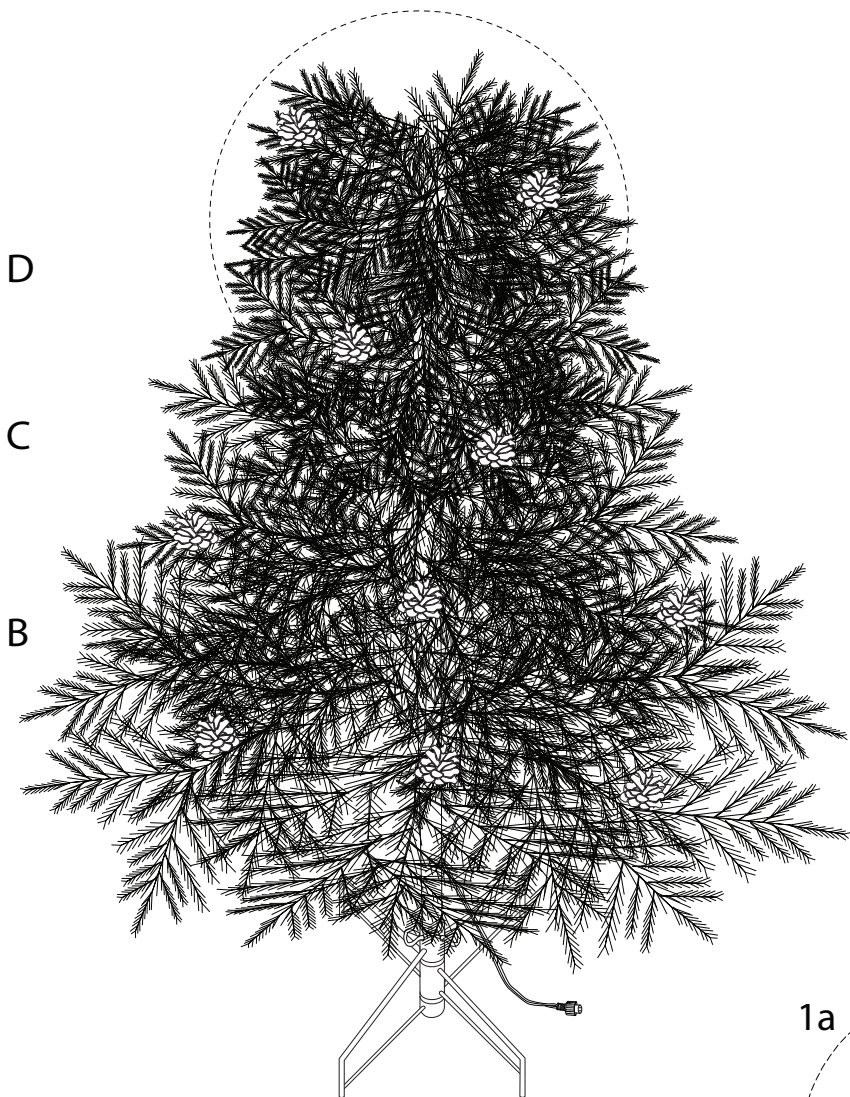

5

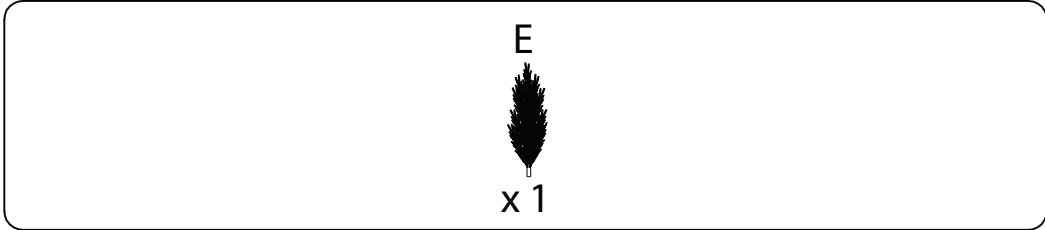

E

D

C

B

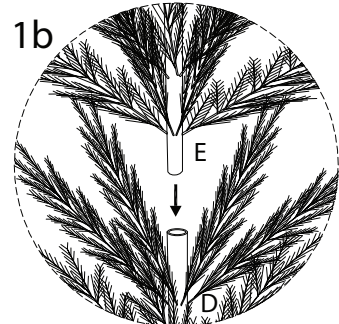
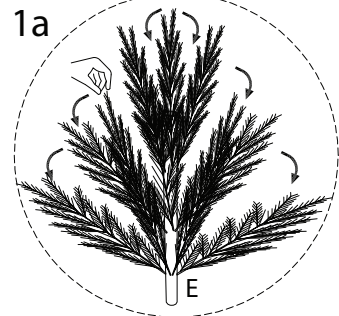
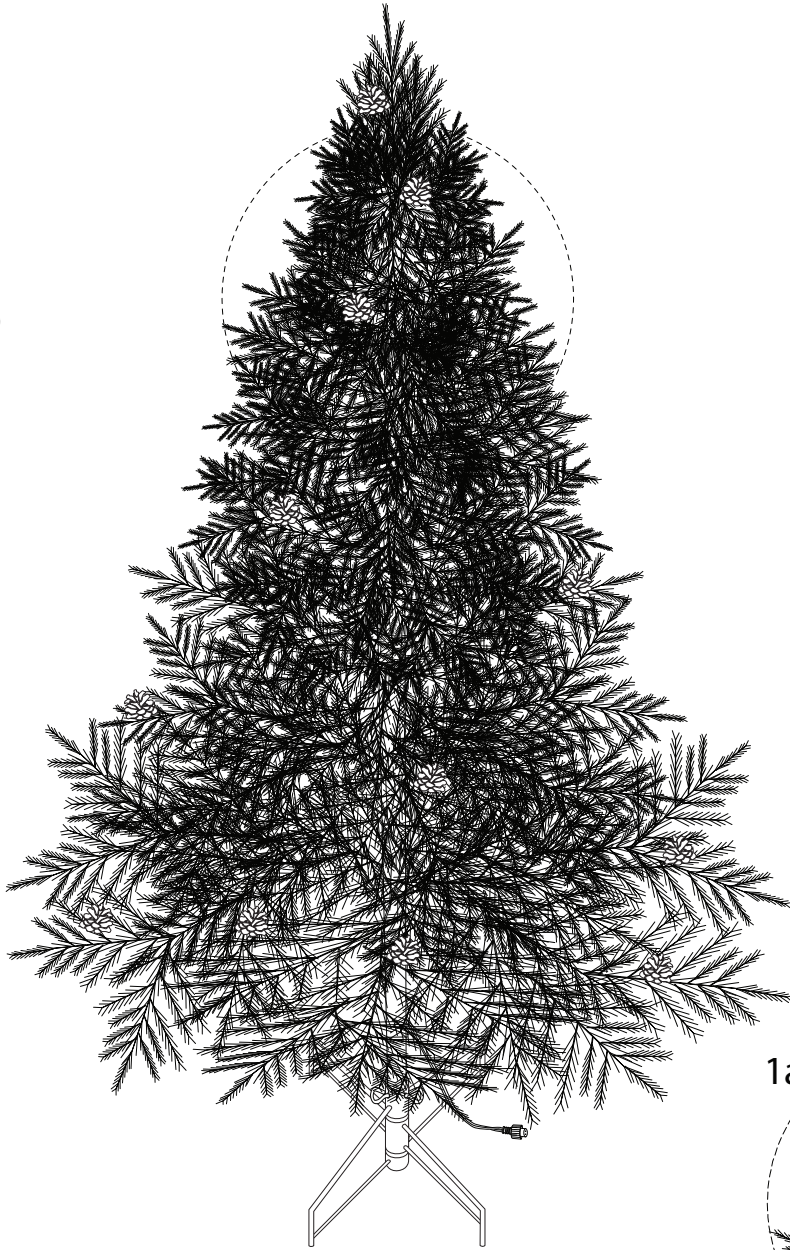

6

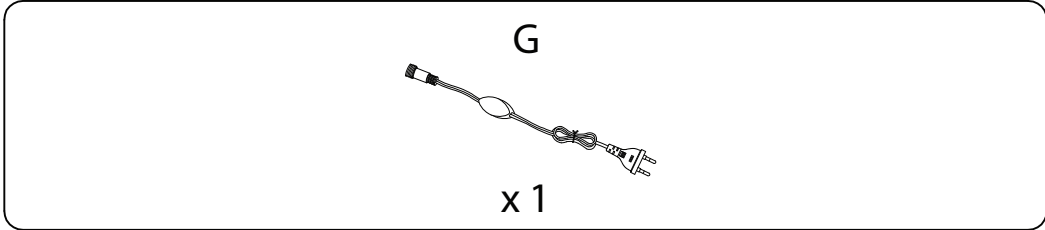

E

D

C

B

