

10'

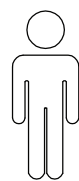
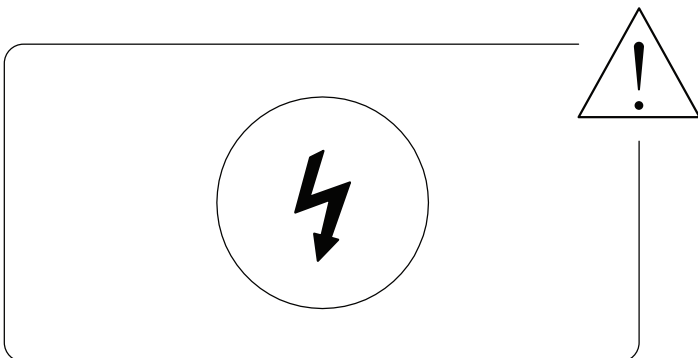

1

1/3

A



C

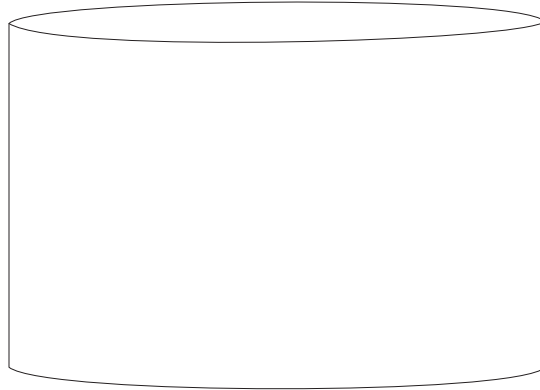

B

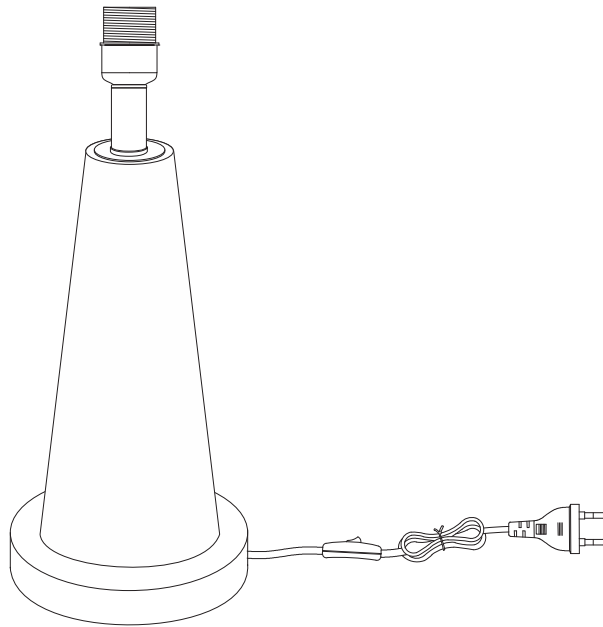

A

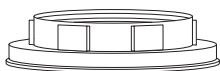

x 1

B

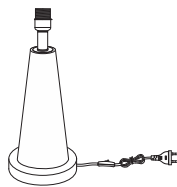

x 1

C



x 1

1

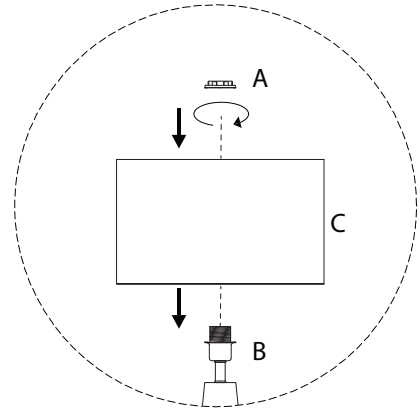
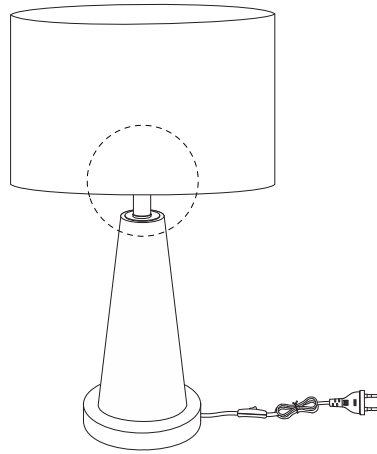
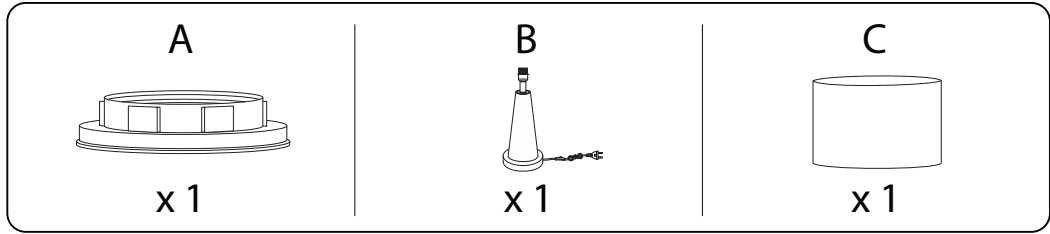

2

