

30'

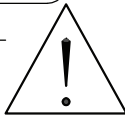

1

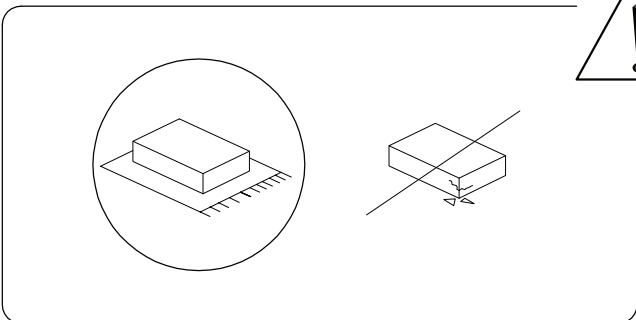
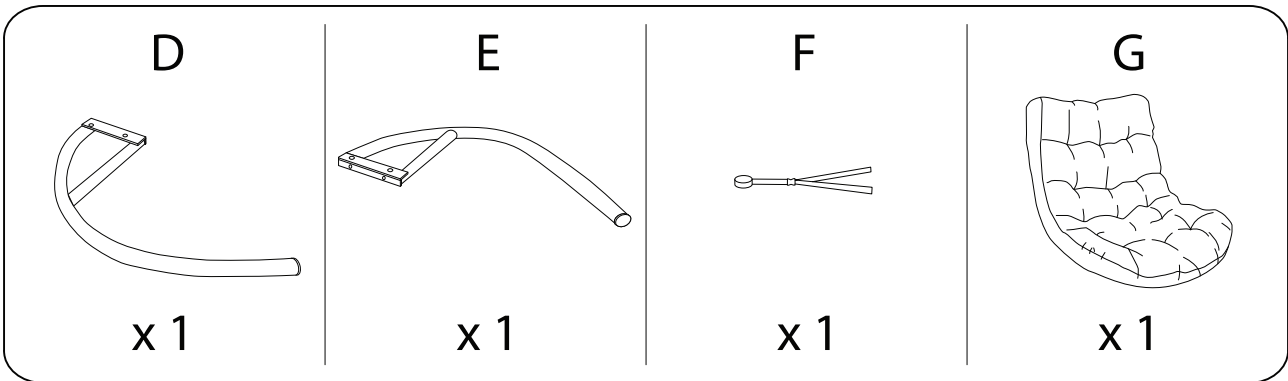
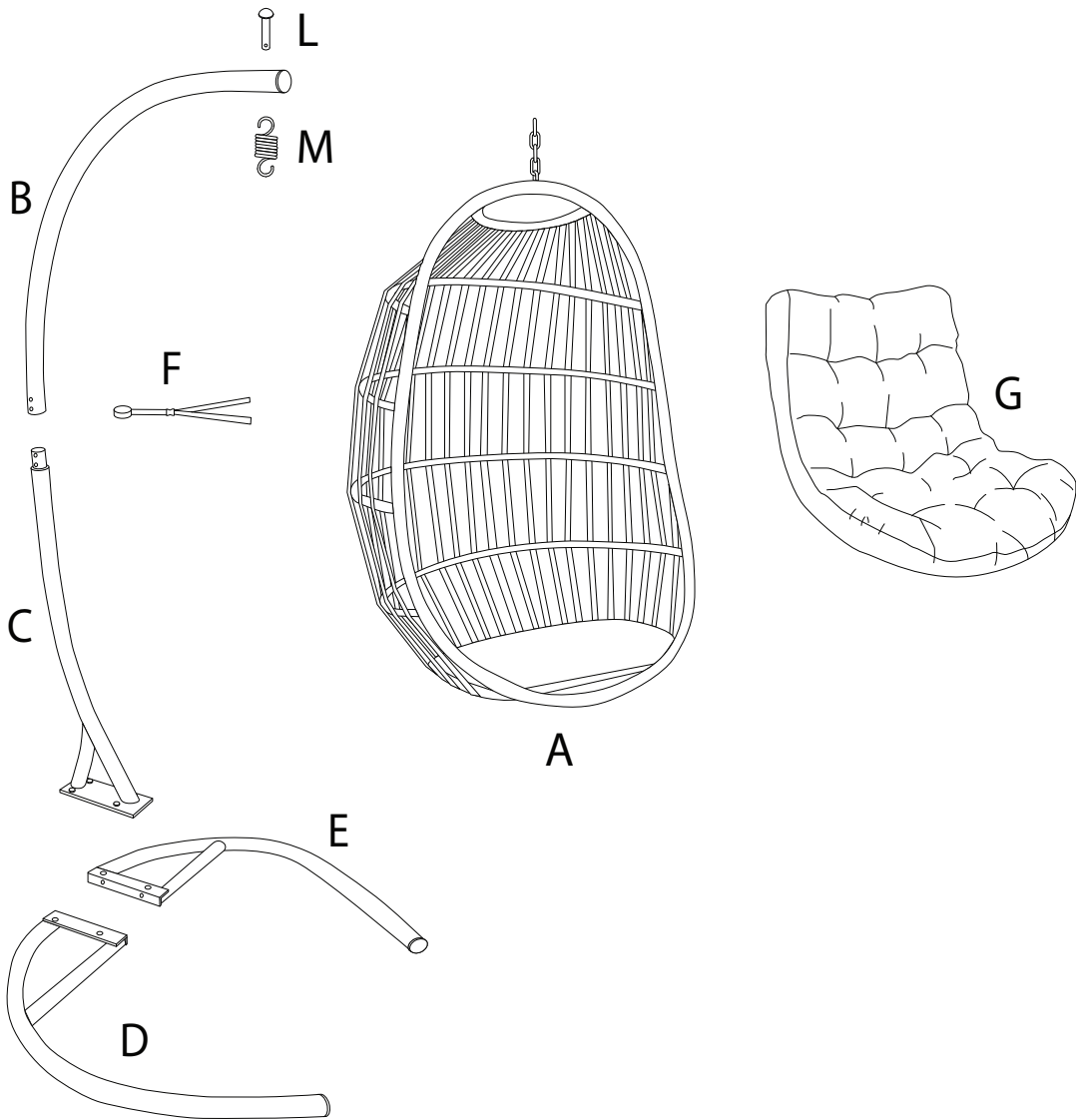
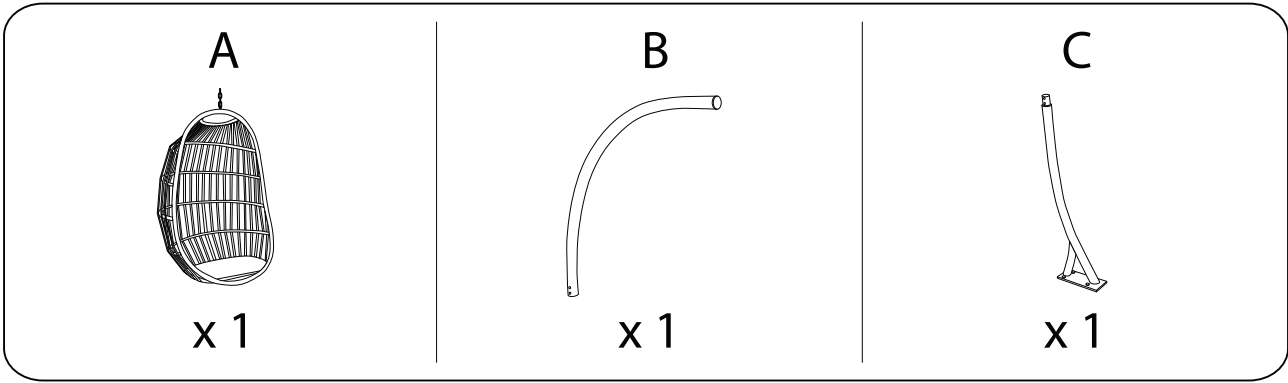

H

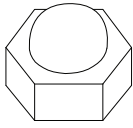

x 2

I

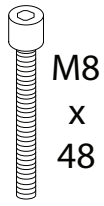

x 2

J

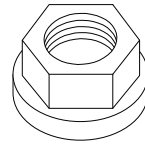

x 6

K



x 6

L



x 1

M



x 1

N

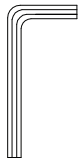

x 1

O

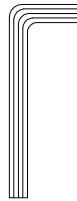

x 1

P

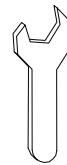

x 1

1

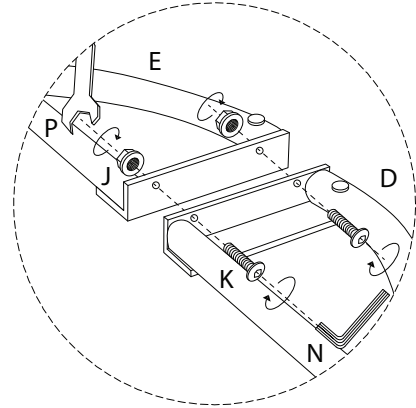
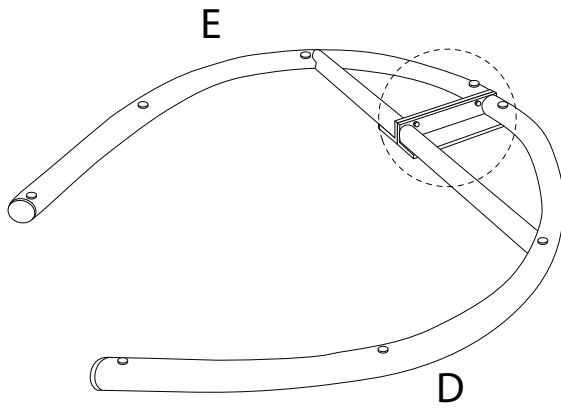
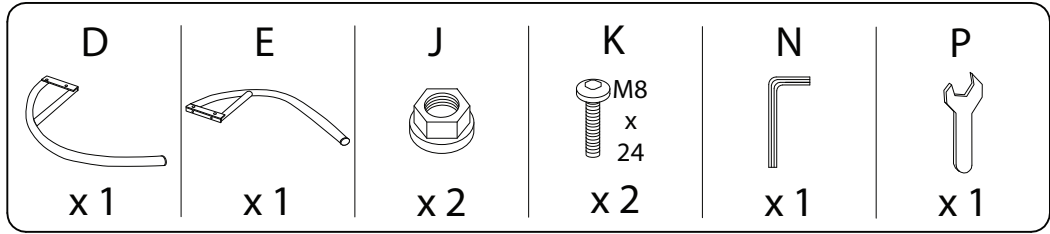

2

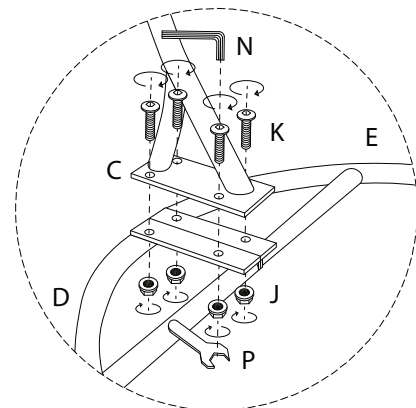
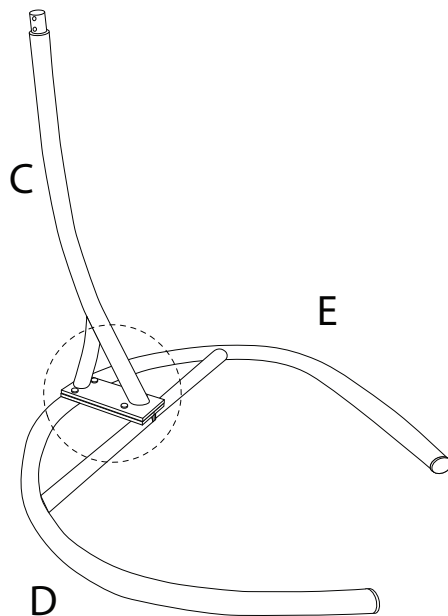
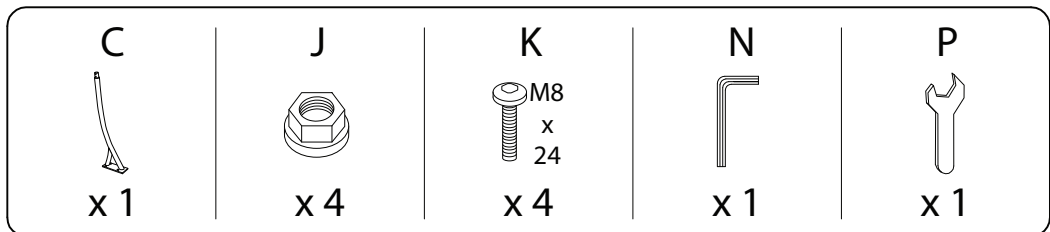

3

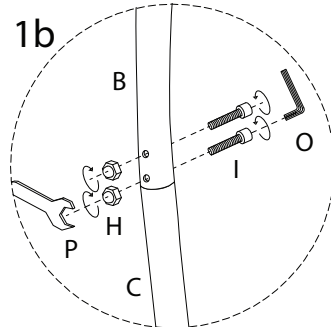
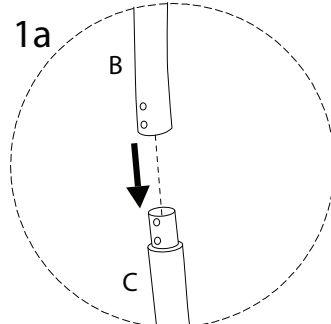
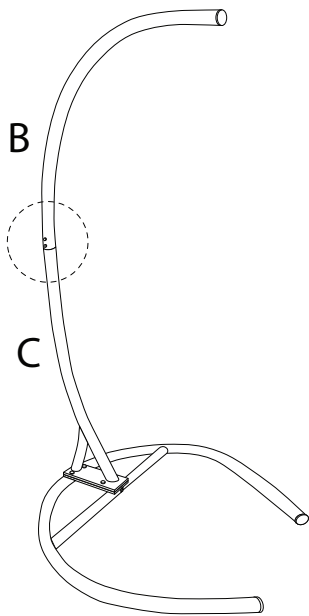
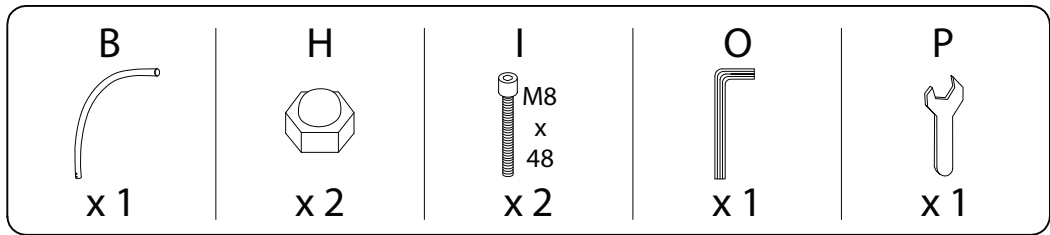

4

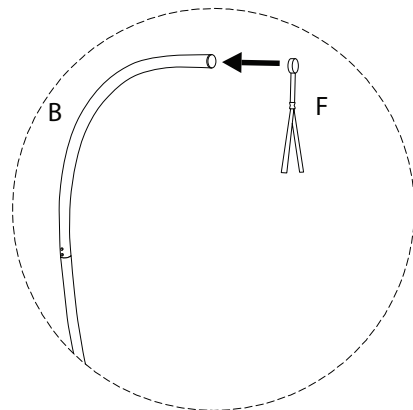
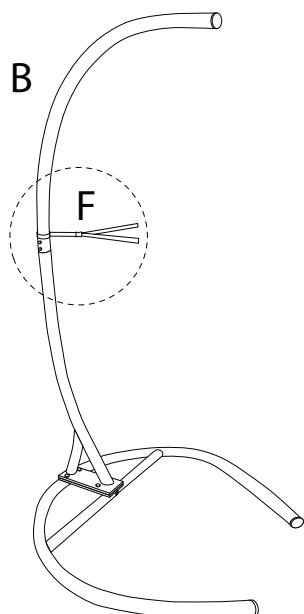
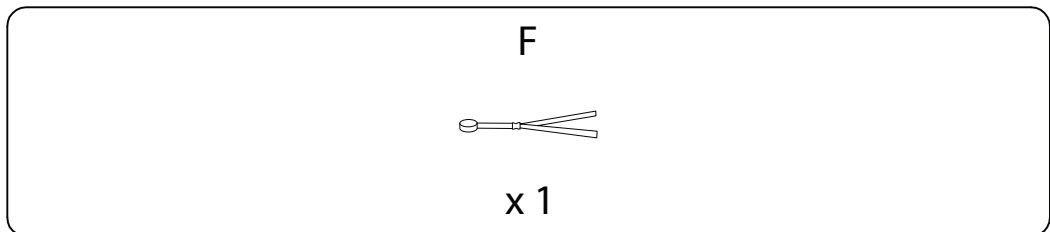

5

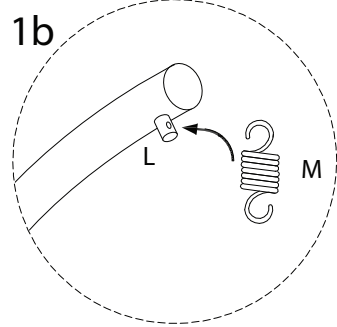
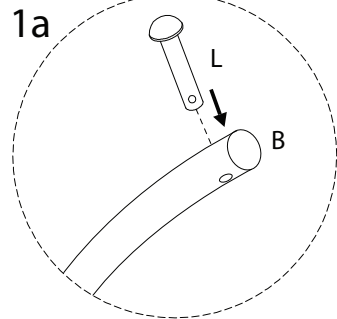
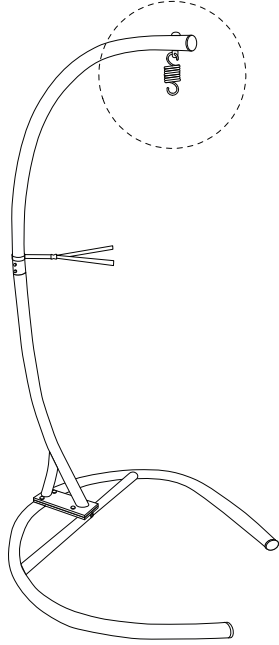
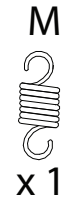

6

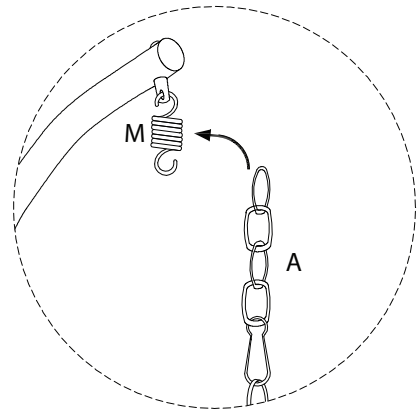
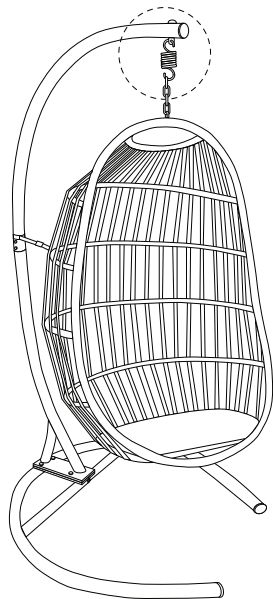

7

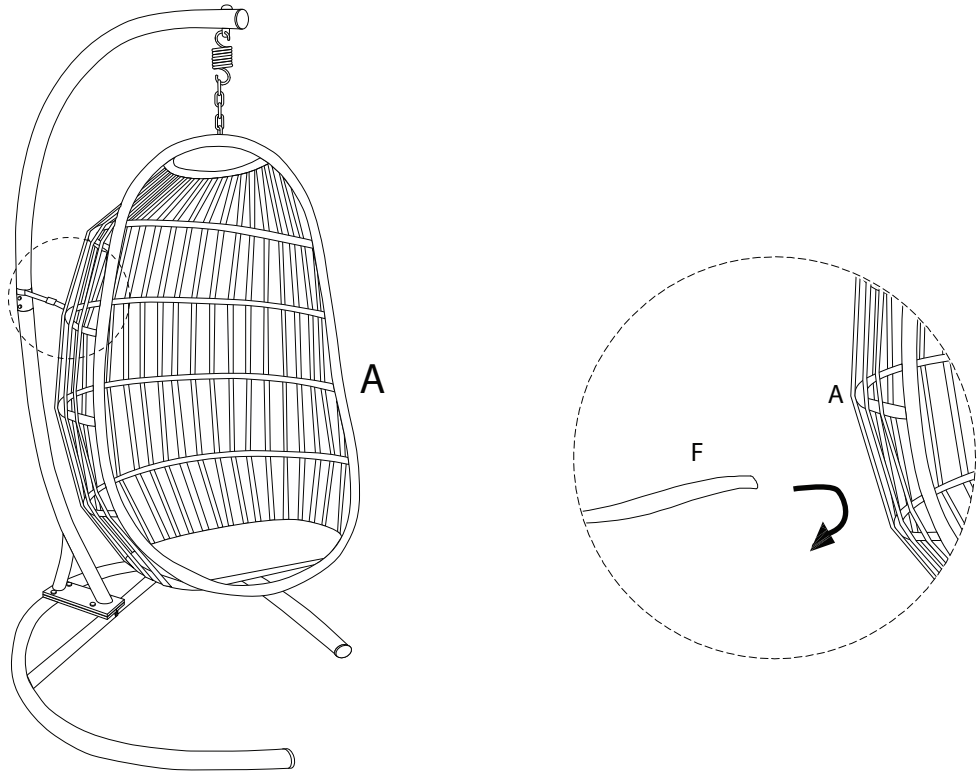

8

