

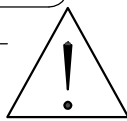

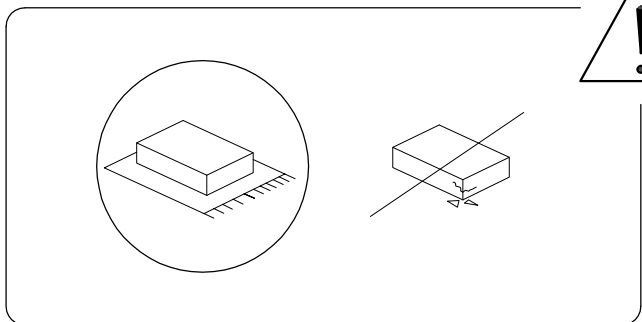

30'

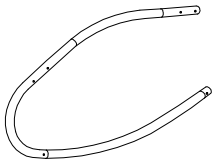



1

1/5

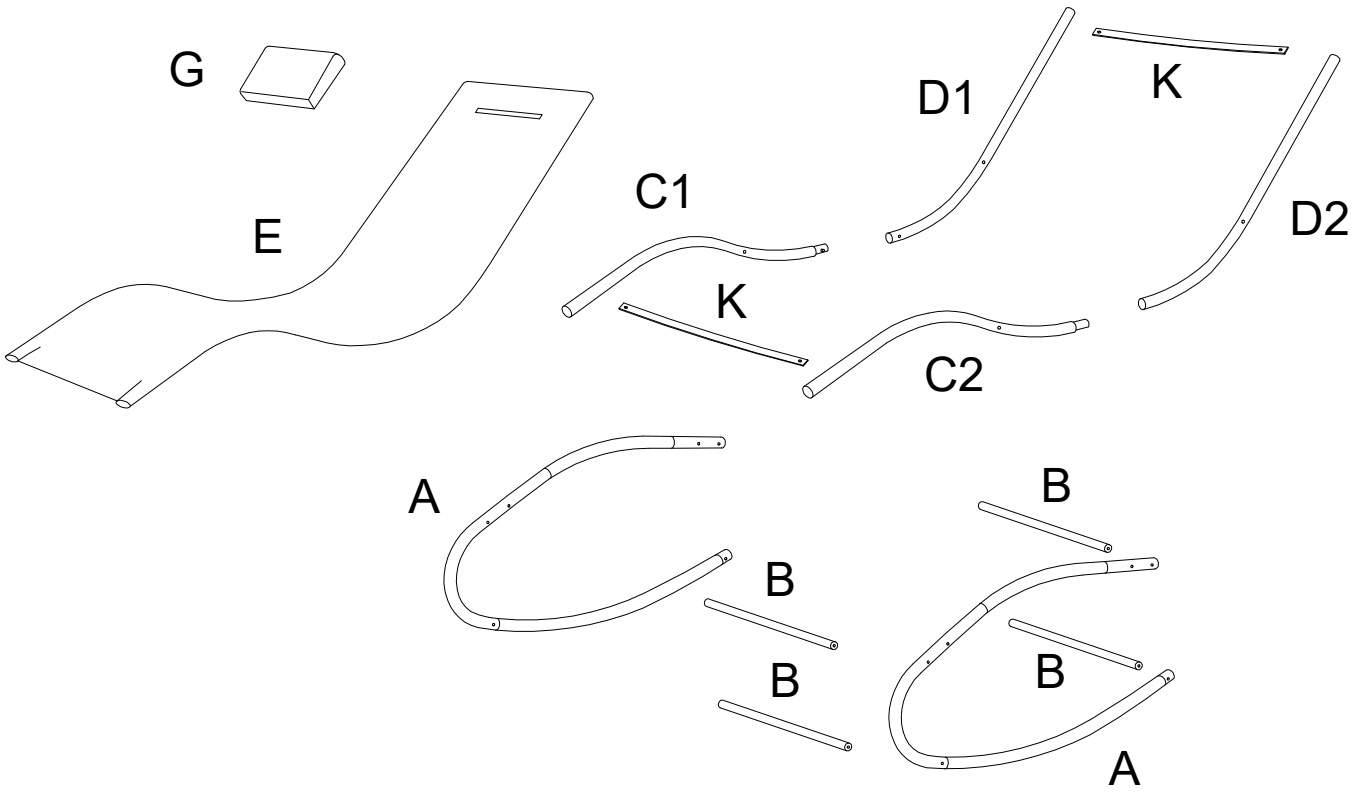
A	B	C1	C2
			
x 2	x 4	x 1	x 1

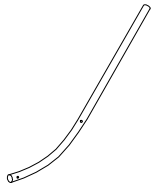
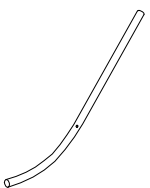
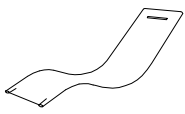
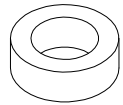
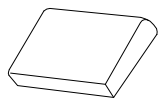
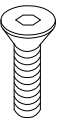
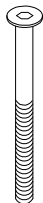
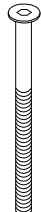
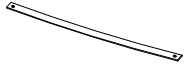

D1	D2	E	F	G
				
x 1	x 1	x 1	x 4	x 1
H	I	J	K	L
				
x 4	x 8	x 4	x 2	x 1

1

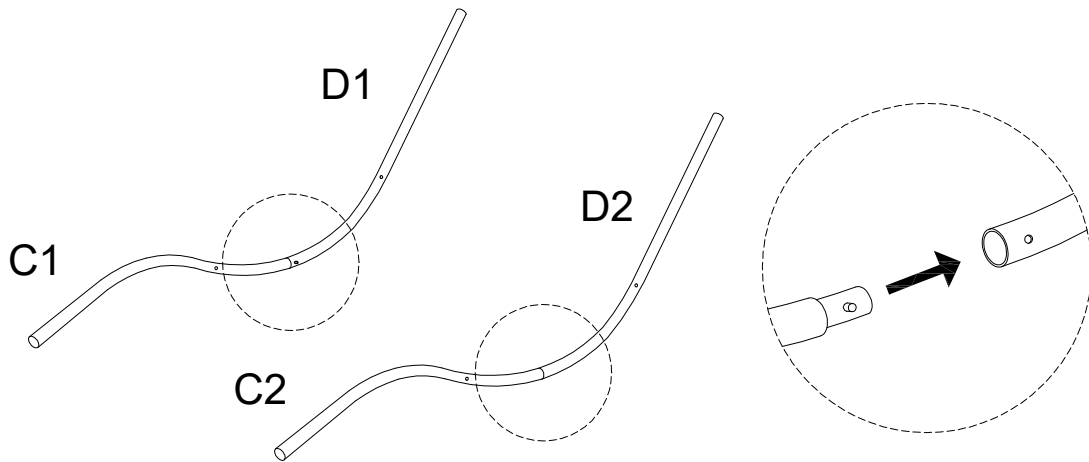
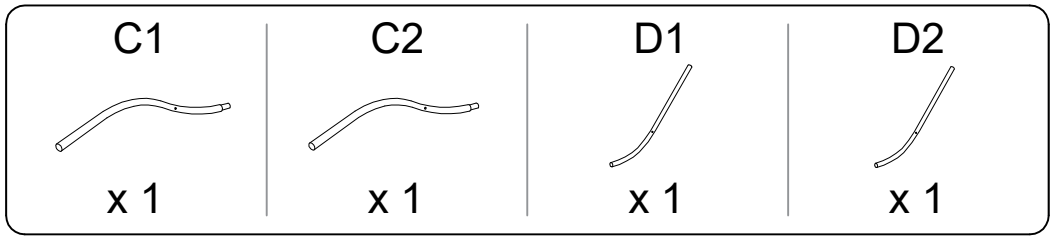

2

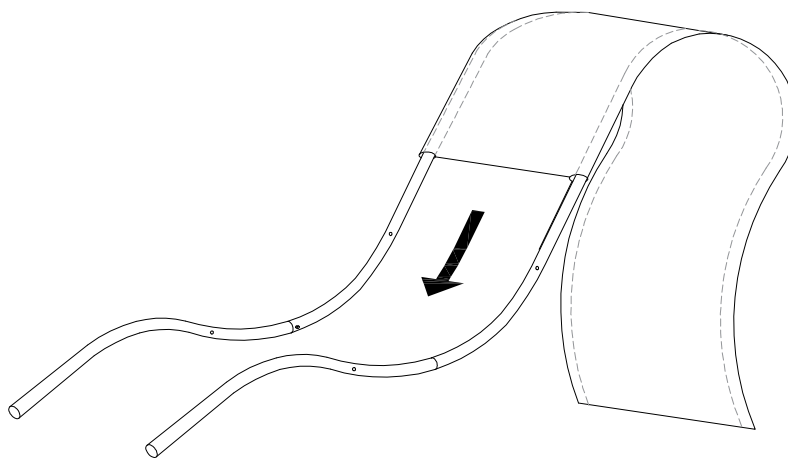
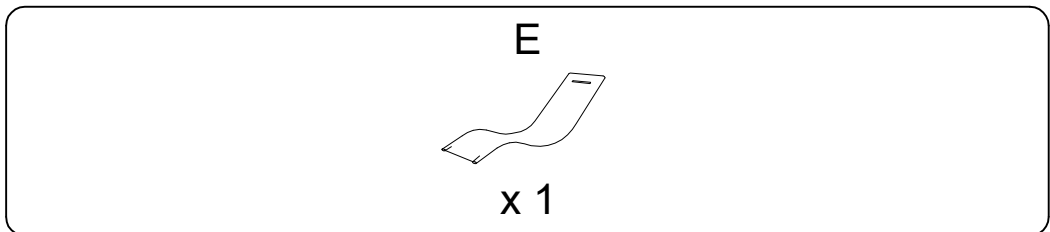

3

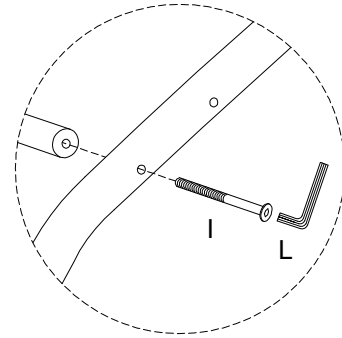
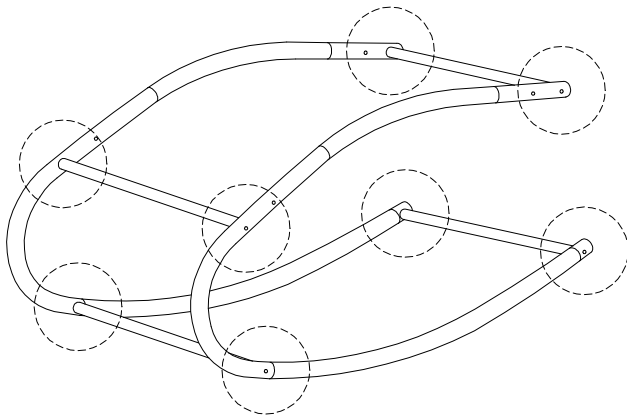
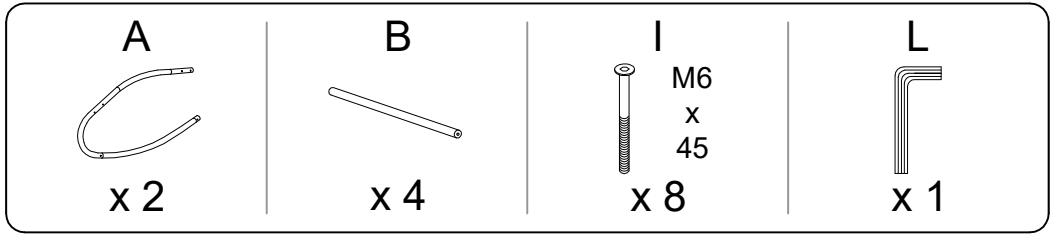

4

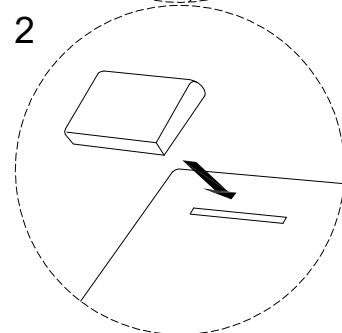
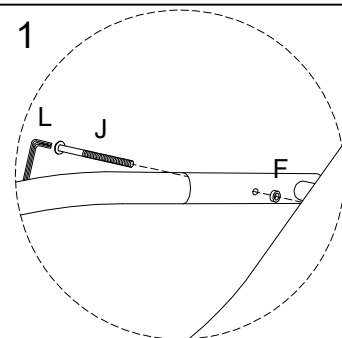
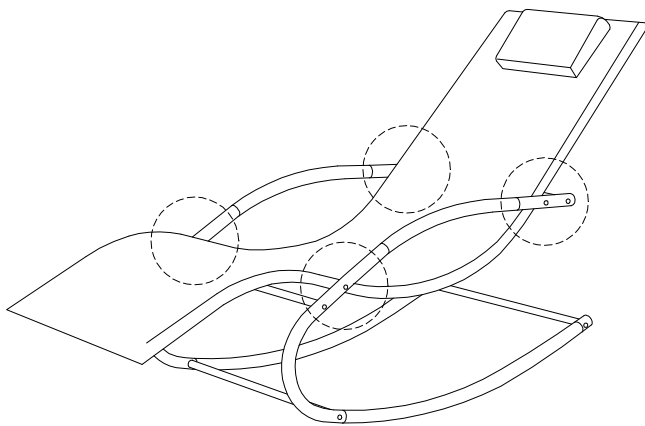
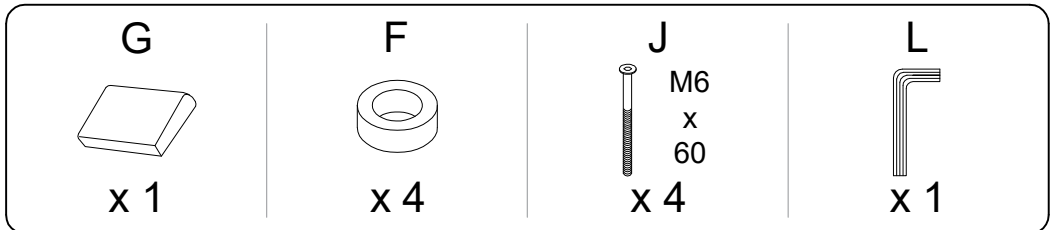

5

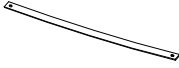
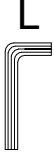
<p>H</p>  <p>M6 x 20</p> <p>x 4</p>	<p>K</p>  <p>x 2</p>	<p>L</p>  <p>x 1</p>
--	---	---

