

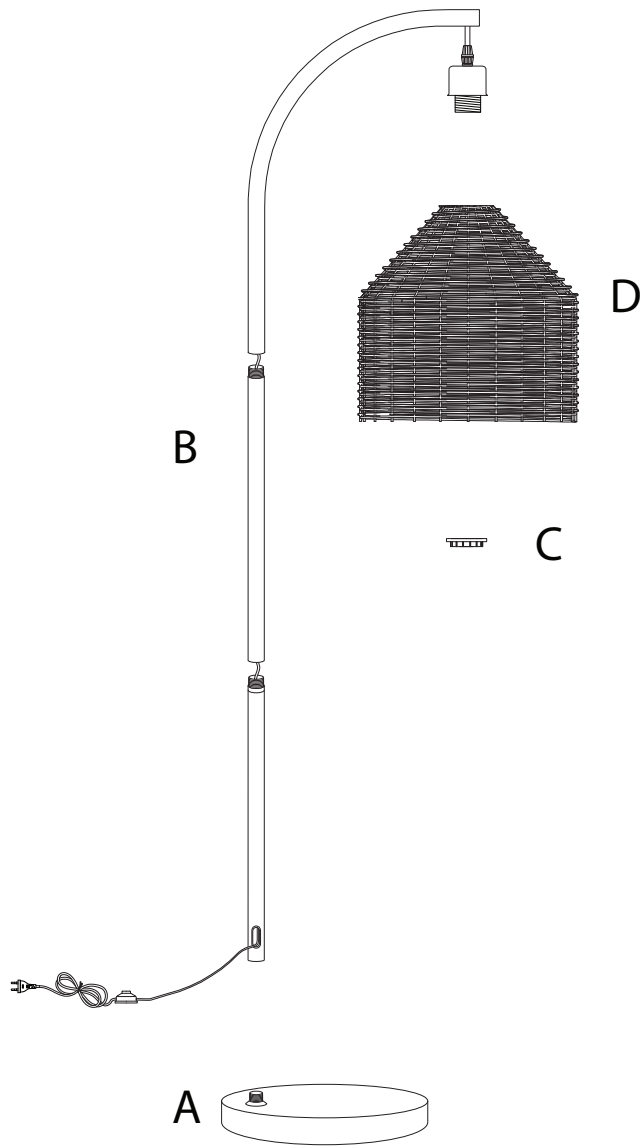



1/4

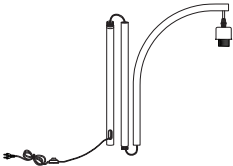

A	B	C	D
			
x 1	x 1	x 1	x 1

1

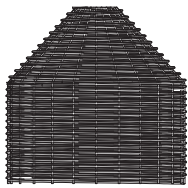
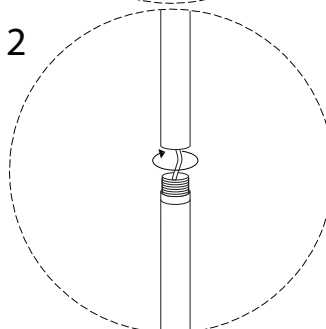
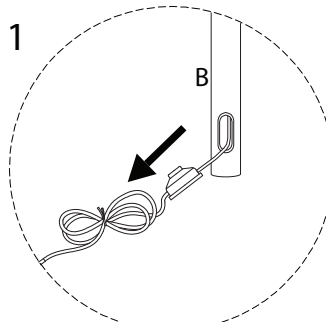
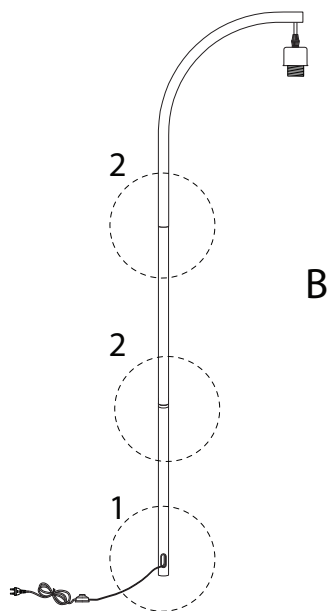
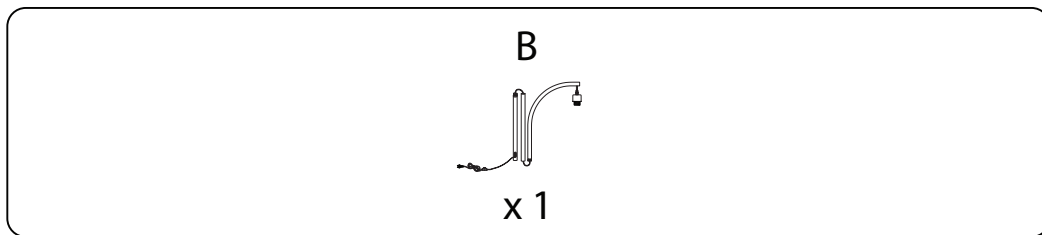

2

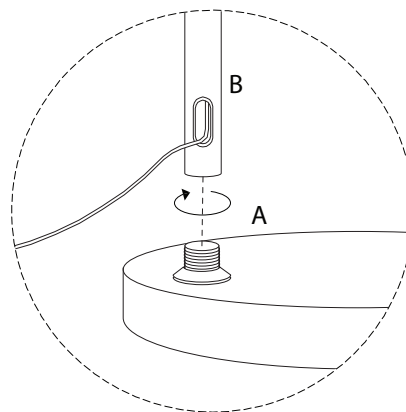
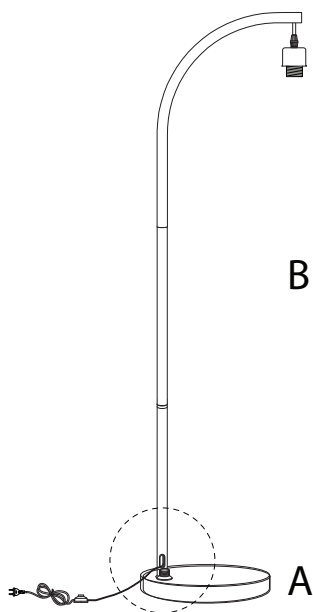
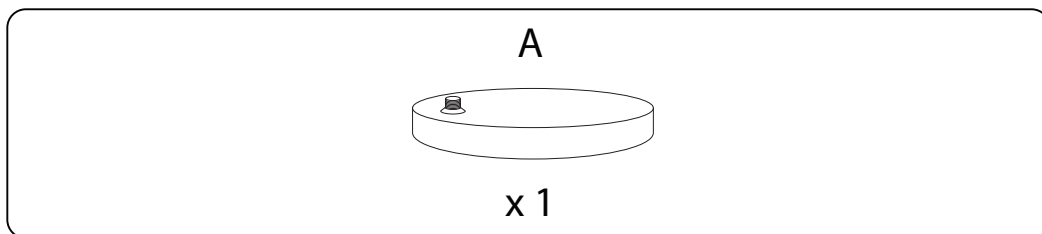

3

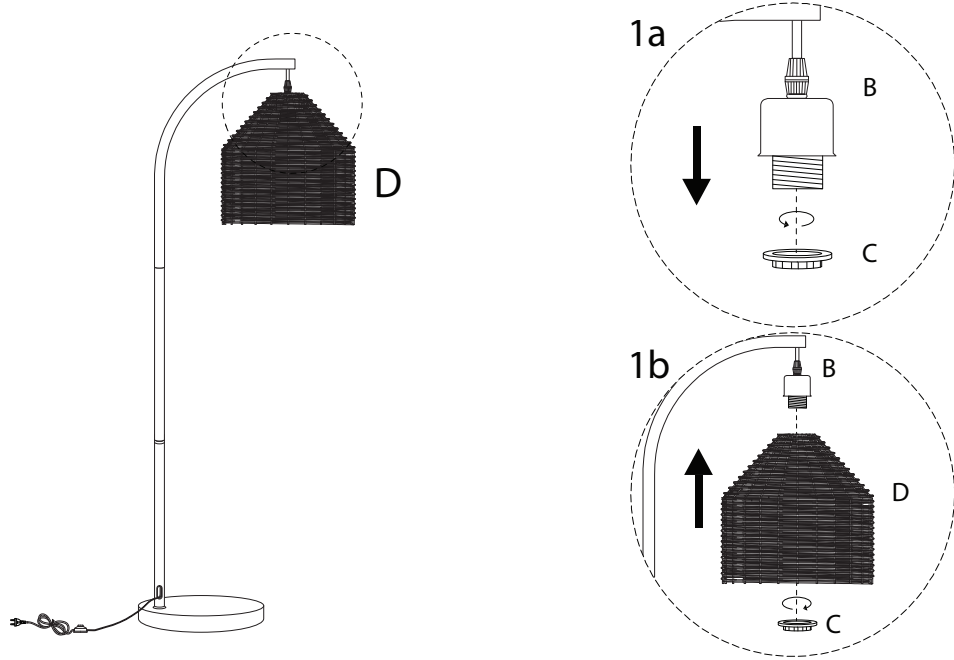
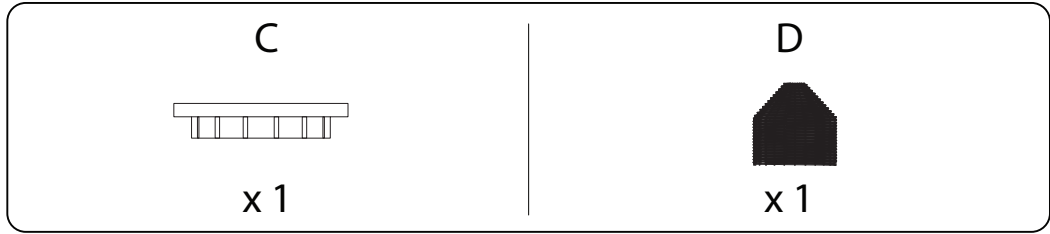

4

