

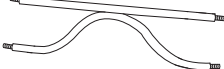



1/4

A	B	C	D
			
x 2	x 1	x 1	x 2

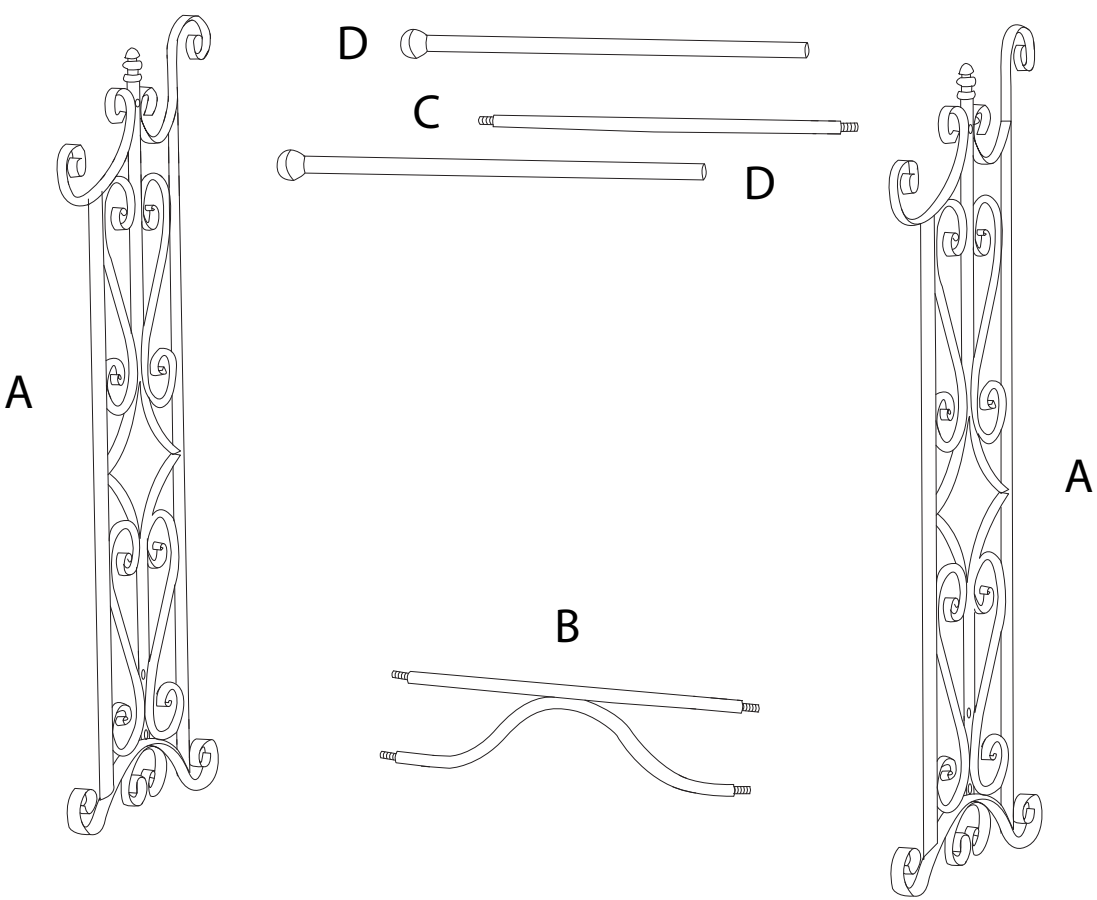
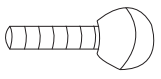

E	F	G	H	I
				
x 2	x 2	x 4	x 1	x 1

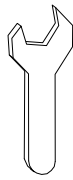
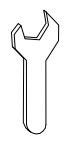
!

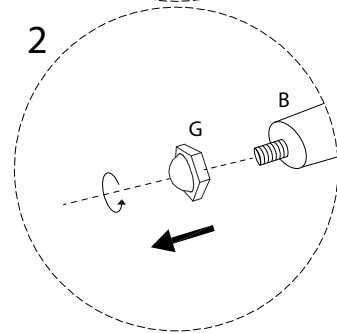
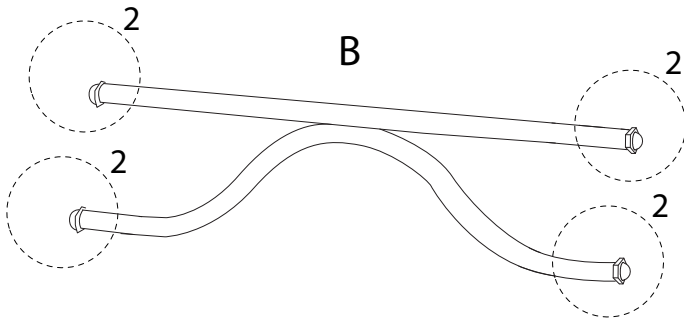
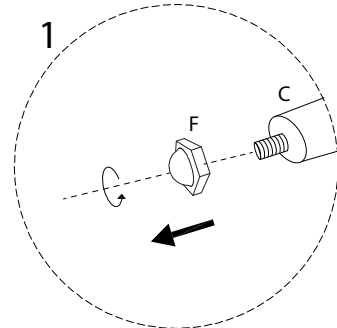
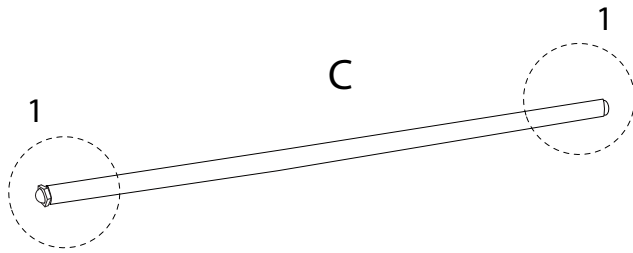

!

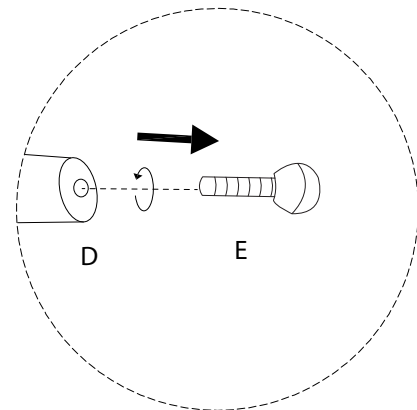
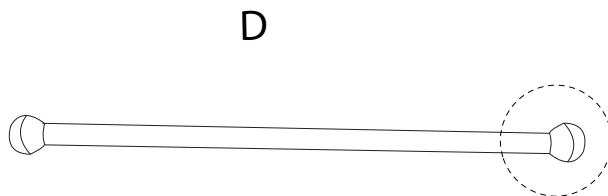

1

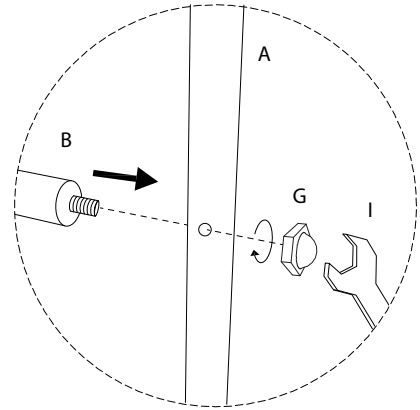
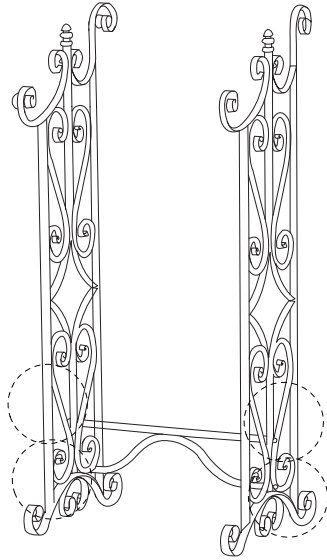
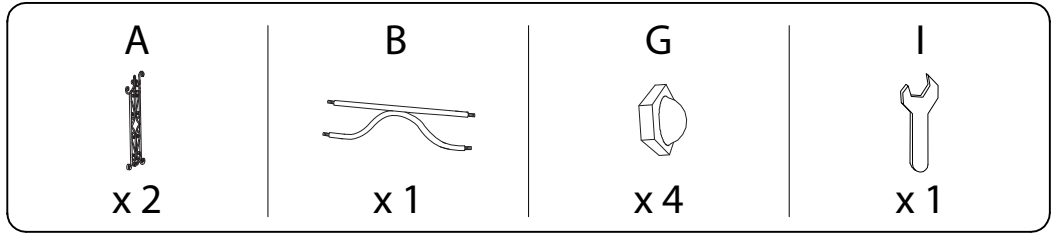

2

