

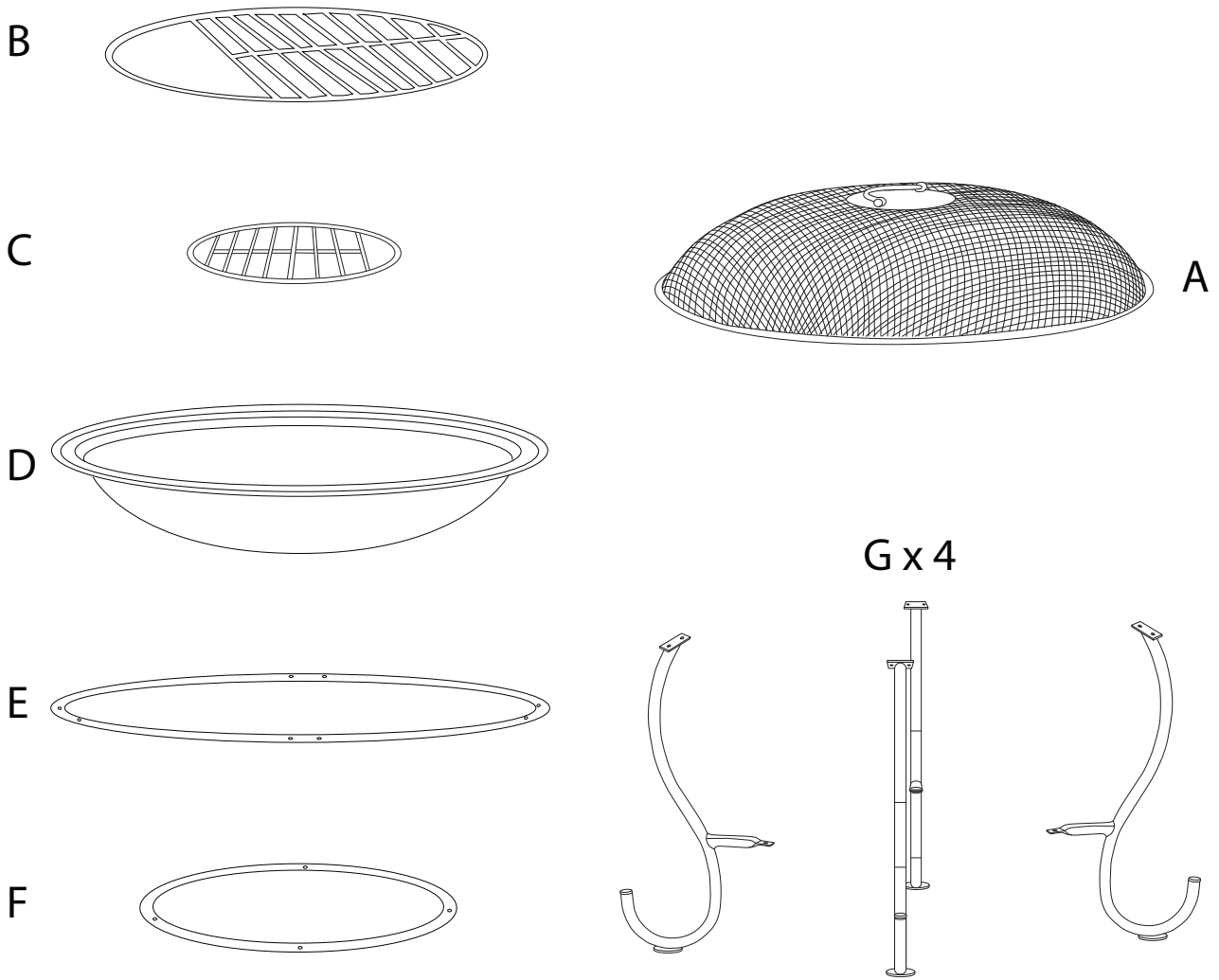

15'

1

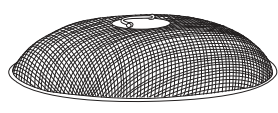
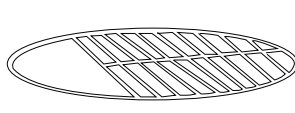
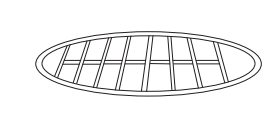

A	B	C	D
			
x 1	x 1	x 1	x 1

E

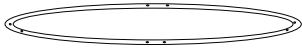

x 1

F

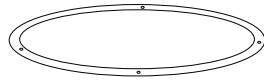

x 1

G



x 4

T1

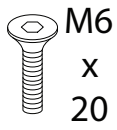

x 4

T2



x 8

U

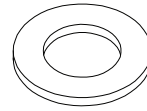

x 12

V

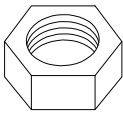

x 12

X

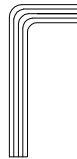

x 1

Y

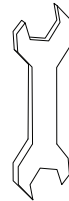





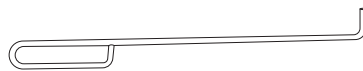

x 1

Z





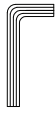

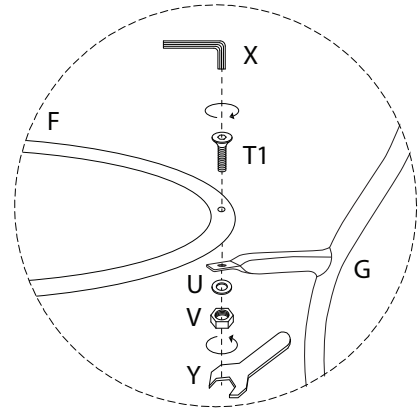
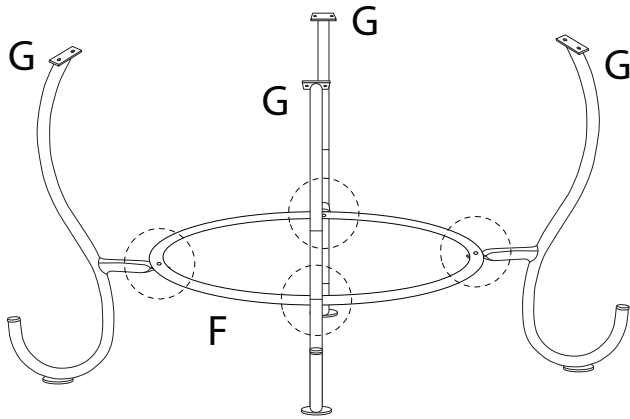

x 1

1

G  x4	F  x1	T1  x4	U  x4	V  x4	X  x1	Y  x1
---	---	--	---	--	---	---

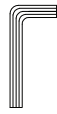

2

E  x1	T2  x8	V  x8	U  x8	X  x1	Y  x1
---	--	---	--	---	---

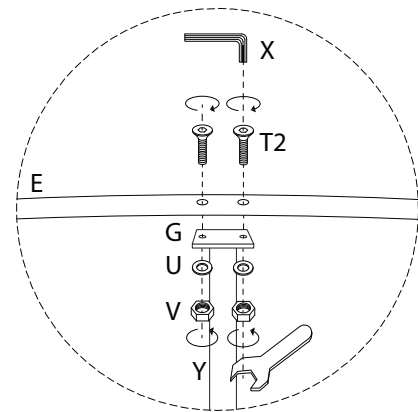
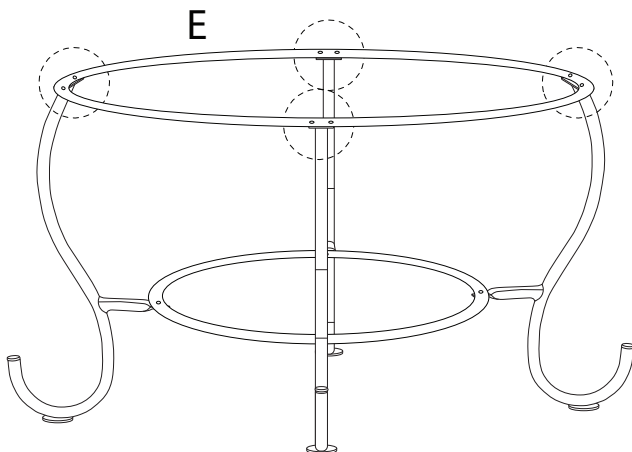

3

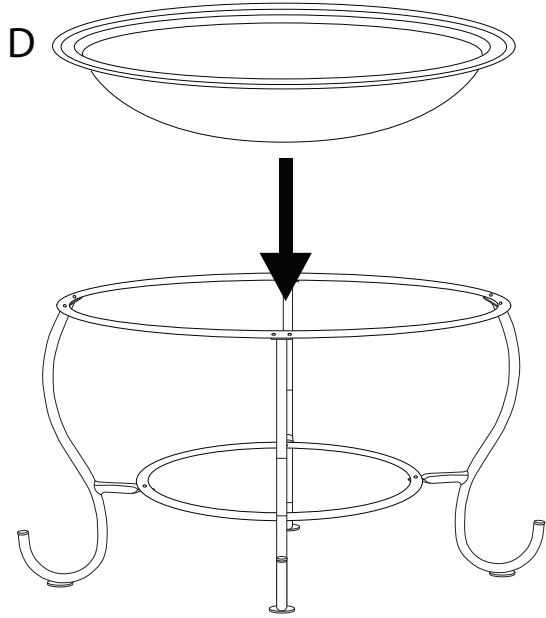
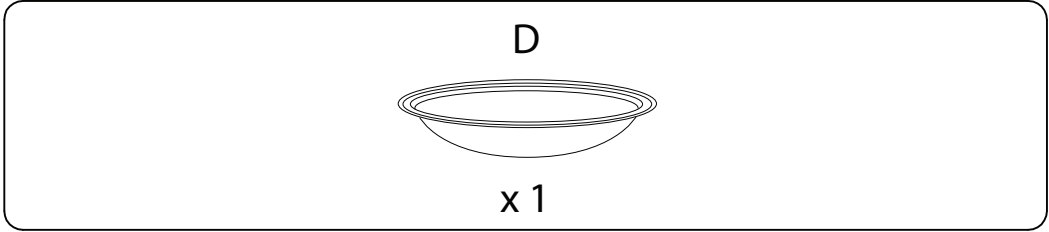

4

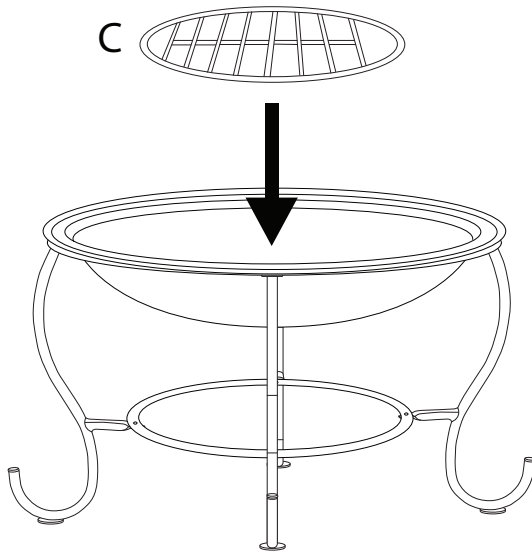
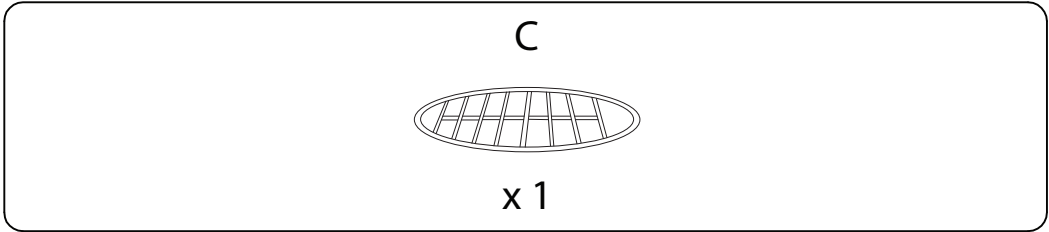

5

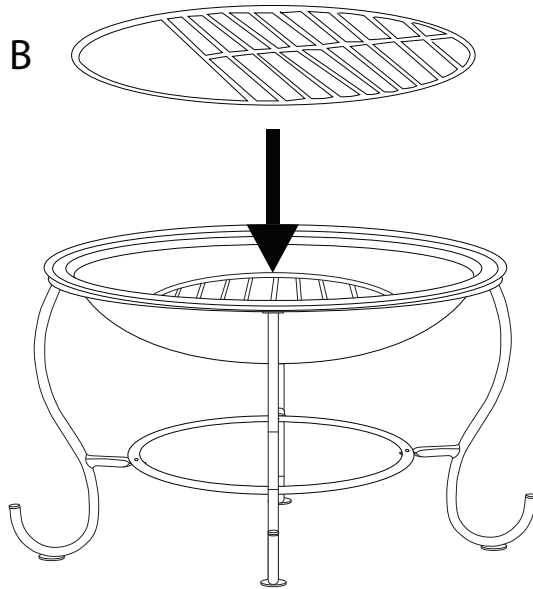
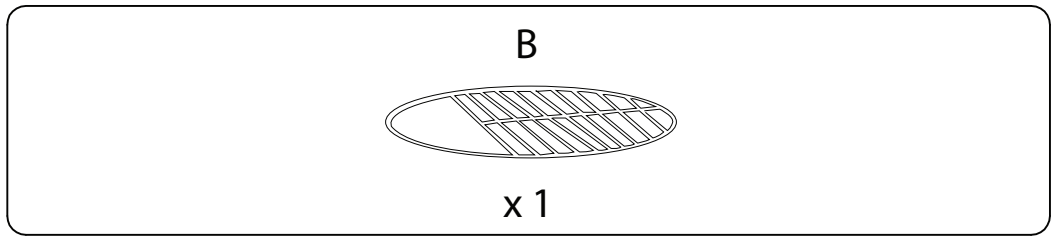

6

