

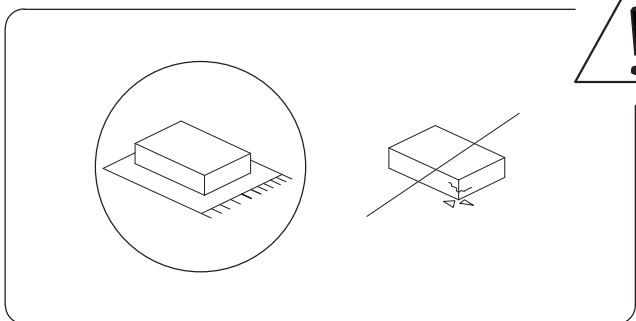

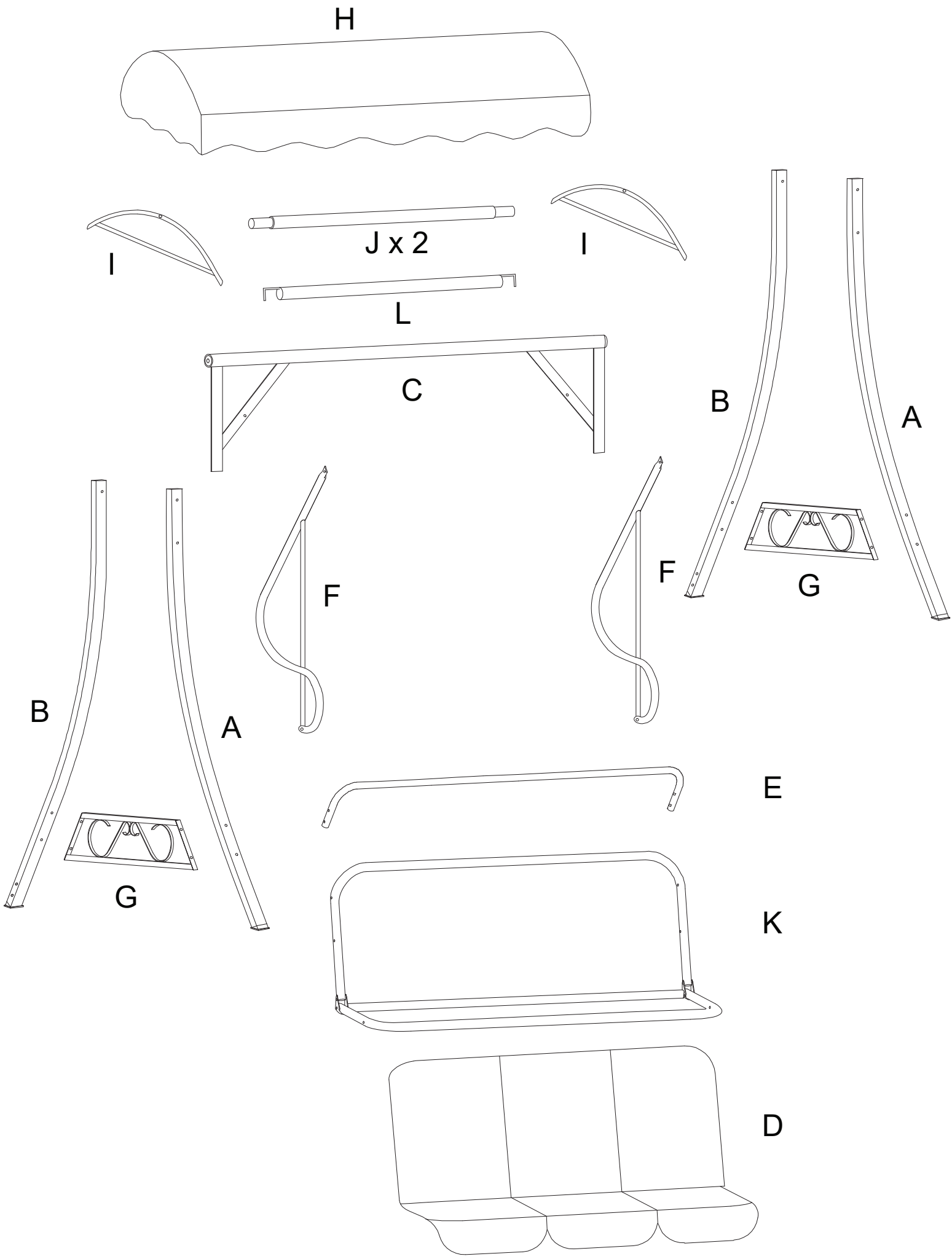









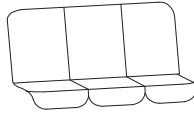

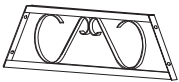

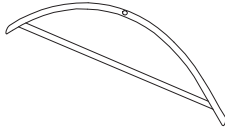

60'

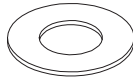



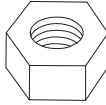
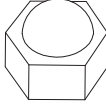
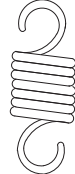
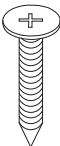
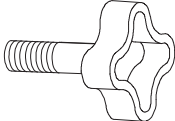

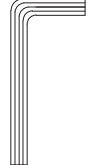
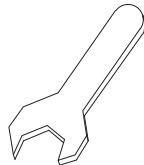





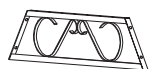

2

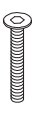

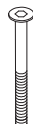
<p>A</p>  <p>x 2</p>	<p>B</p>  <p>x 2</p>	<p>C</p>  <p>x 1</p>	<p>D</p>  <p>x 1</p>	<p>E</p>  <p>x 1</p>
<p>F</p>  <p>x 2</p>	<p>G</p>  <p>x 2</p>	<p>H</p>  <p>x 1</p>	<p>I</p>  <p>x 2</p>	<p>J</p>  <p>x 2</p>
<p>K</p>  <p>x 1</p>	<p>L</p>  <p>x 1</p>	<p>O</p>  <p>x 22</p>	<p>P1</p>  <p>M6 x 40</p> <p>x 8</p>	<p>P2</p>  <p>M6 x 65</p> <p>x 6</p>
<p>P3</p>  <p>M6 x 72</p> <p>x 4</p>	<p>P4</p>  <p>M6 x 80</p> <p>x 4</p>	<p>Q</p>  <p>x 22</p>	<p>R</p>  <p>x 26</p>	<p>S</p>  <p>x 2</p>
<p>T</p>  <p>M4 x 28</p> <p>x 4</p>	<p>U</p>  <p>x 2</p>	<p>V</p>  <p>x 2</p>	<p>X</p>  <p>x 1</p>	<p>Y</p>  <p>x 1</p>

1

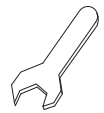
A  x 2	B  x 2	C  x 1	E  x 1	G  x 2	O  x 16	
P1  M6 x 40 x 8	P3  M6 x 72 x 4	P4  M6 x 80 x 4	Q  x 16	R  x 16	X  x 1	Y  x 1

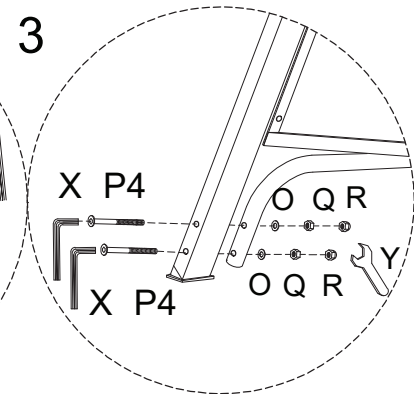
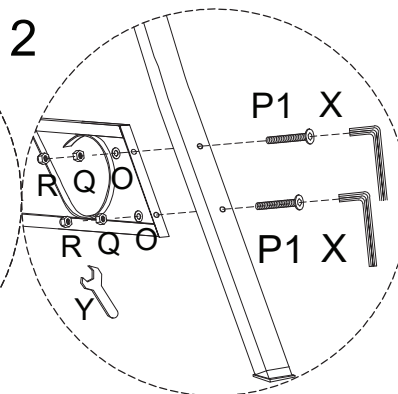
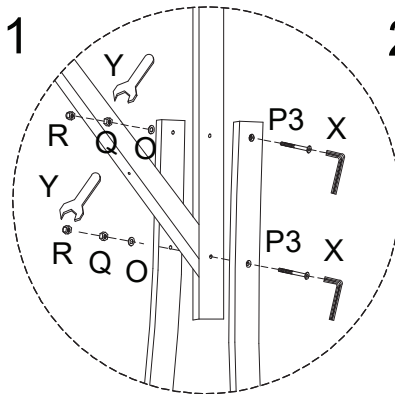
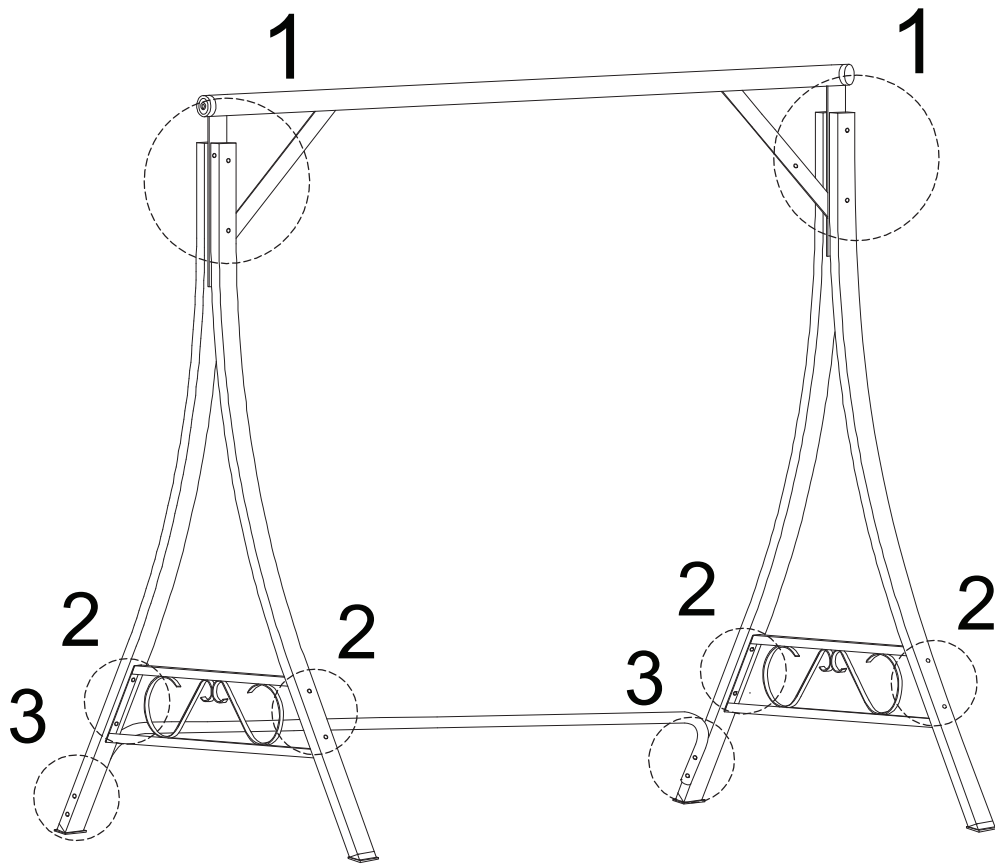



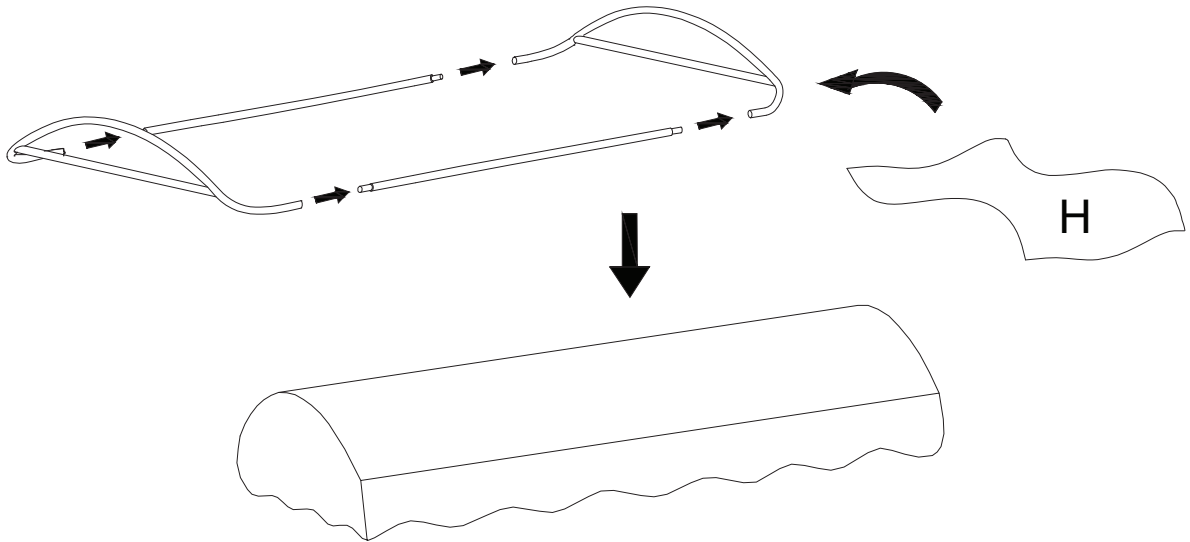
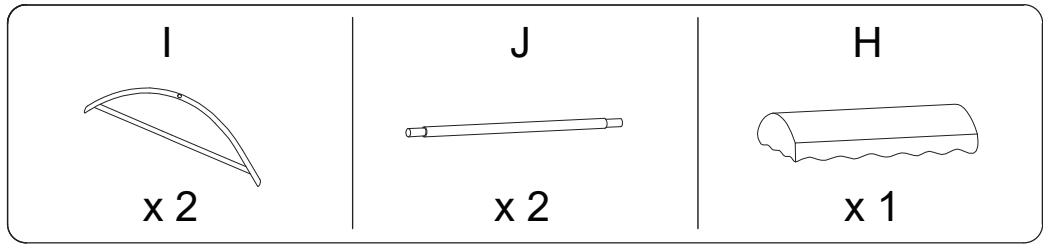

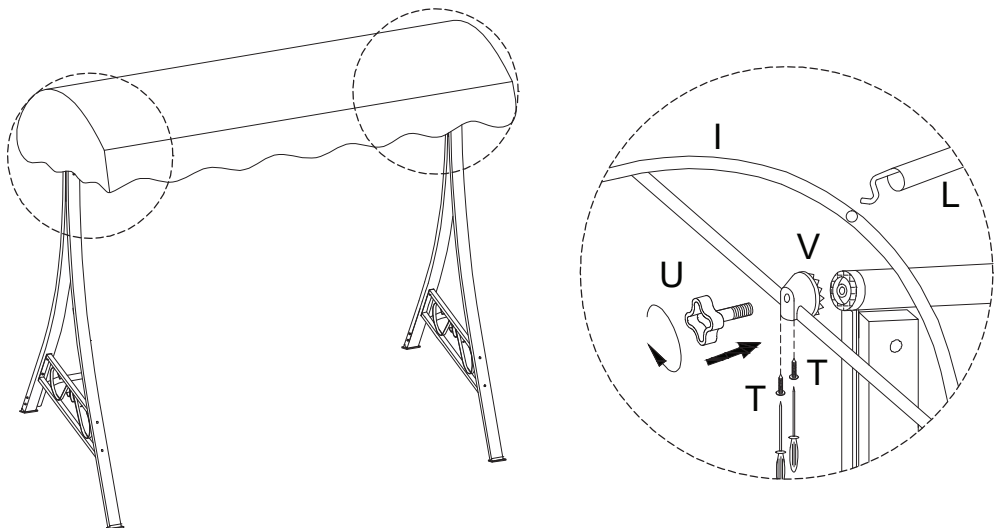
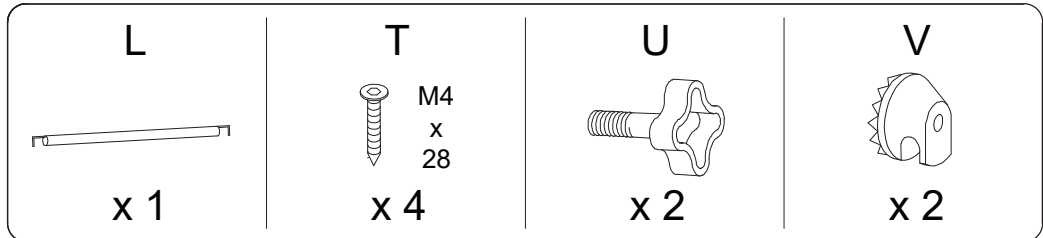

2



3

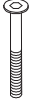

4

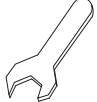
F	K	P2	R	Q	O	Y	X
							
x 2	x 1	x 6	x 10	x 6	x 6	x 1	x 1

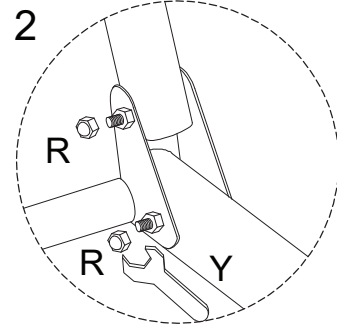
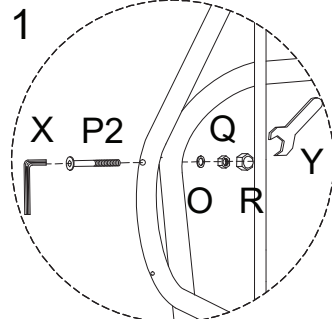
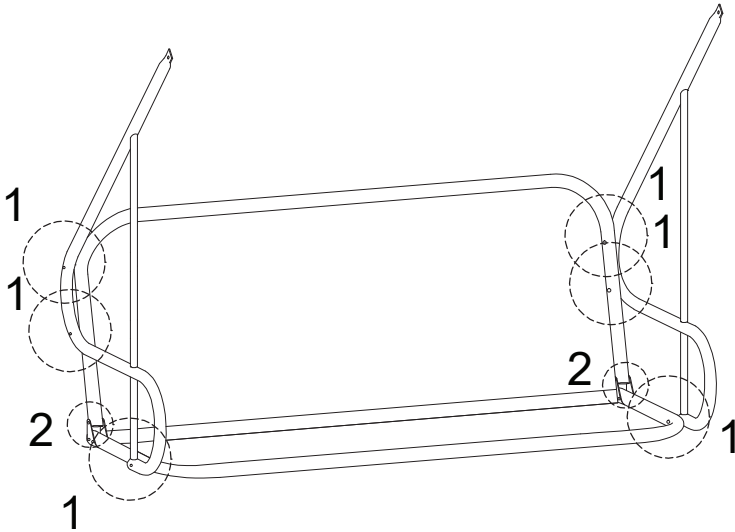

5

S

x 2

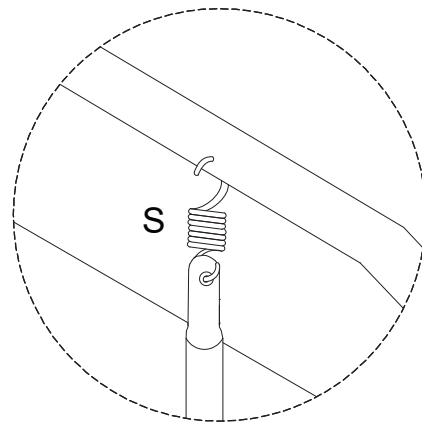
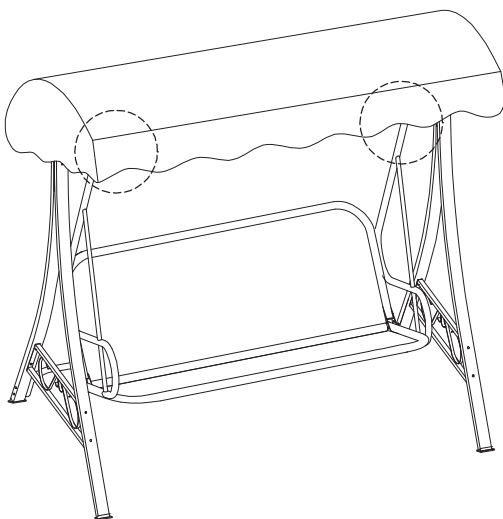

6

