

Assembly instructions for step 1/3:

- Tools:** A screwdriver is shown as the required tool. A power drill is shown with a diagonal line through it, indicating it is not to be used.
- Warning:** A warning triangle with an exclamation mark is positioned above the tool icons.
- Time:** A clock icon is shown next to the text "10'", indicating the estimated assembly time.
- Personnel:** A person icon is shown next to the number "1", indicating that one person is required for assembly.

1/3

A

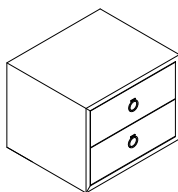

x 1

B

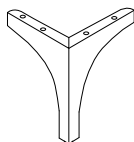

x 4

C

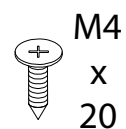

x 16

A

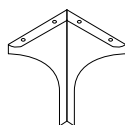
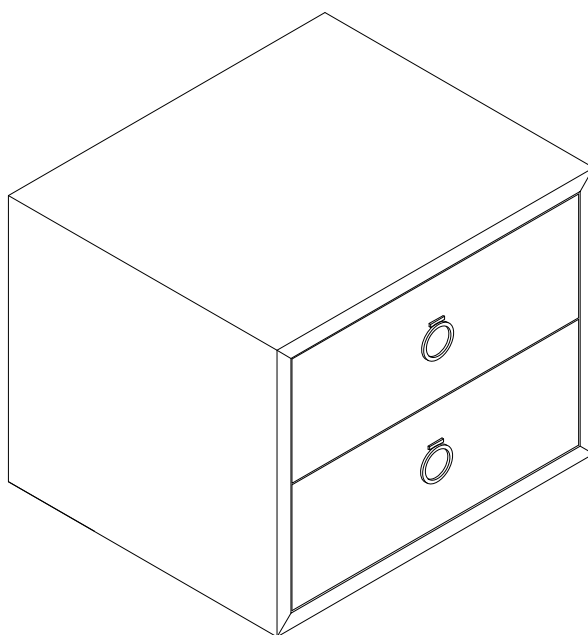

B x 4

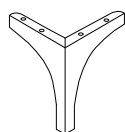
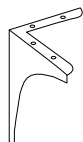

!

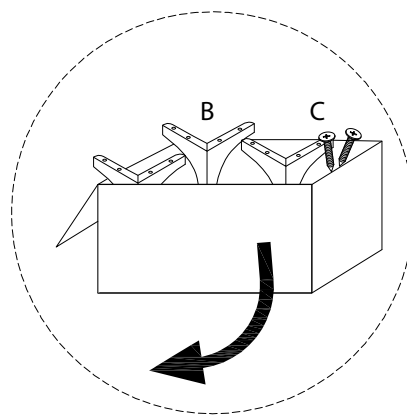
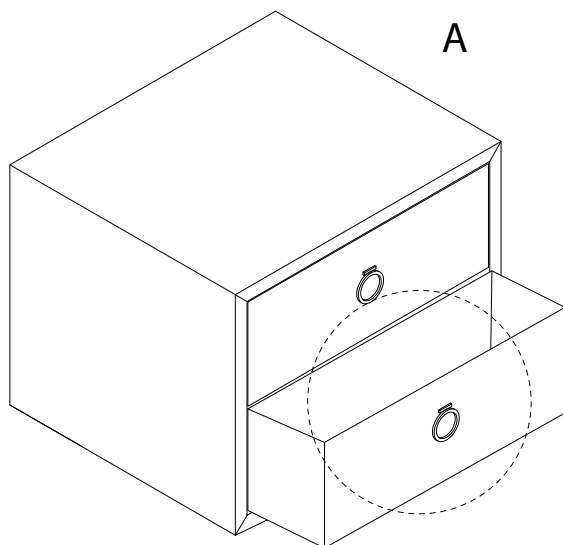

1

