

45'

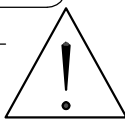

2

1/6

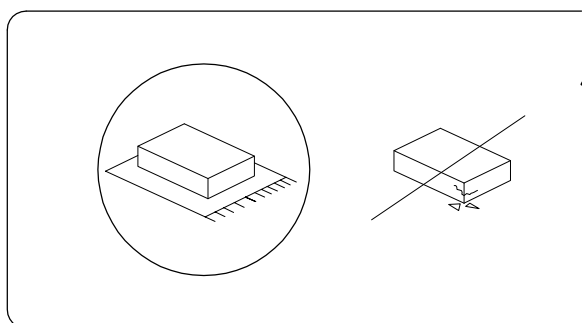
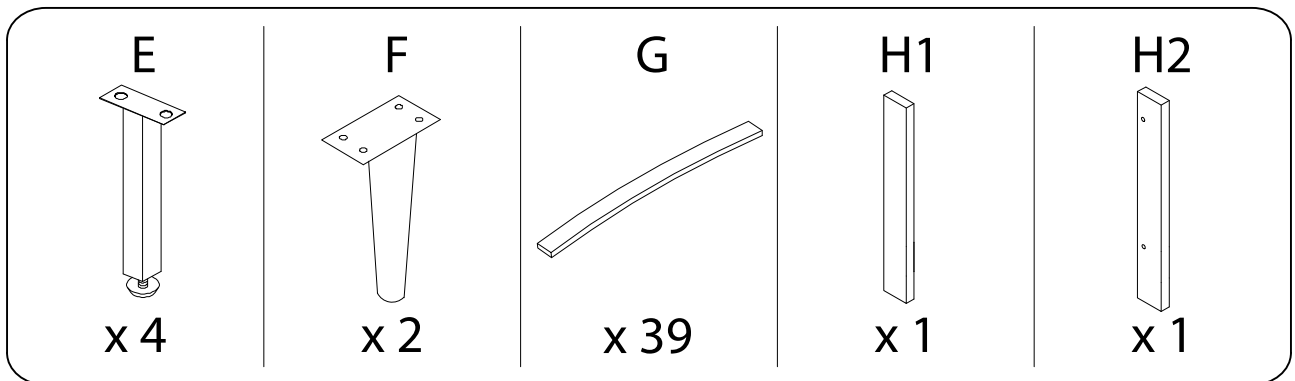
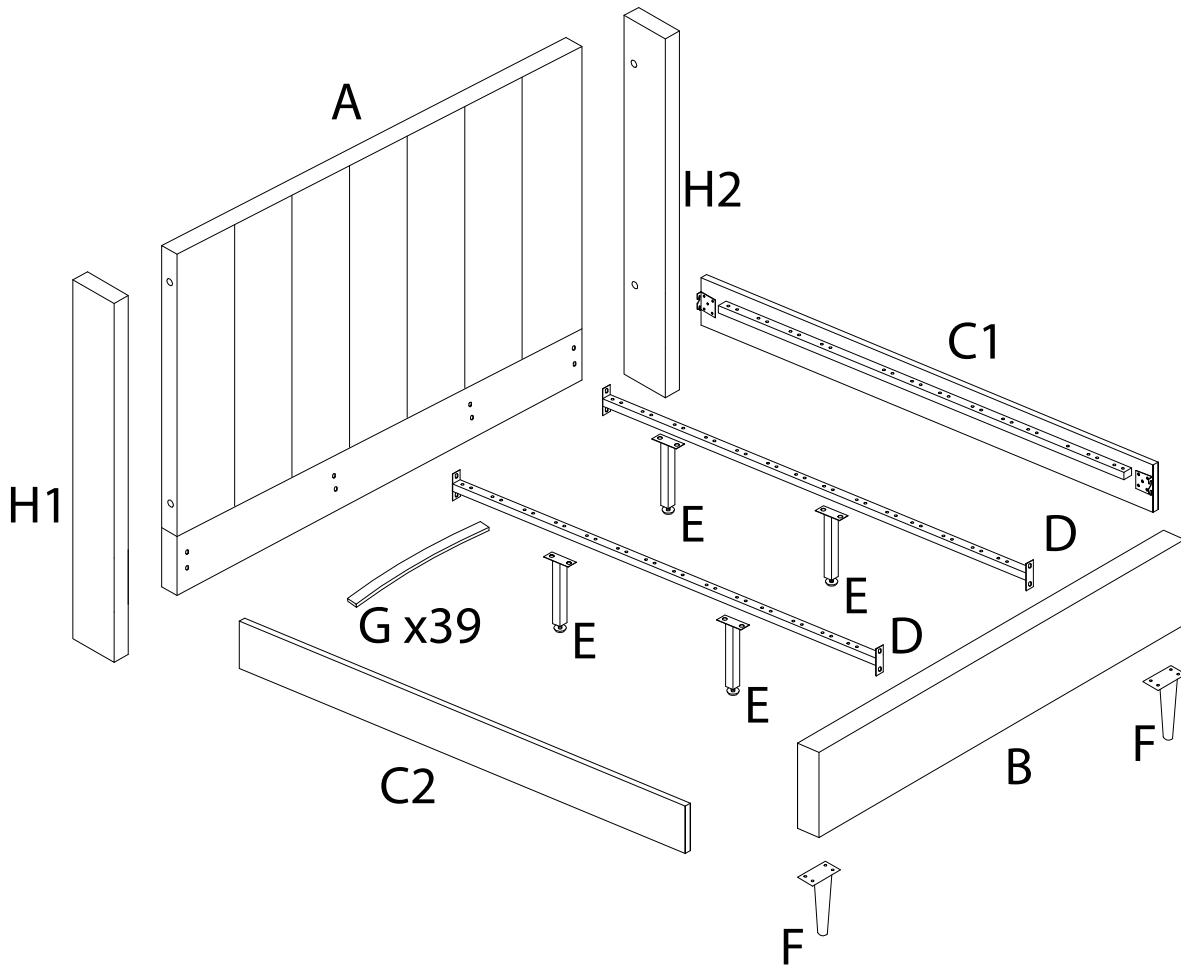
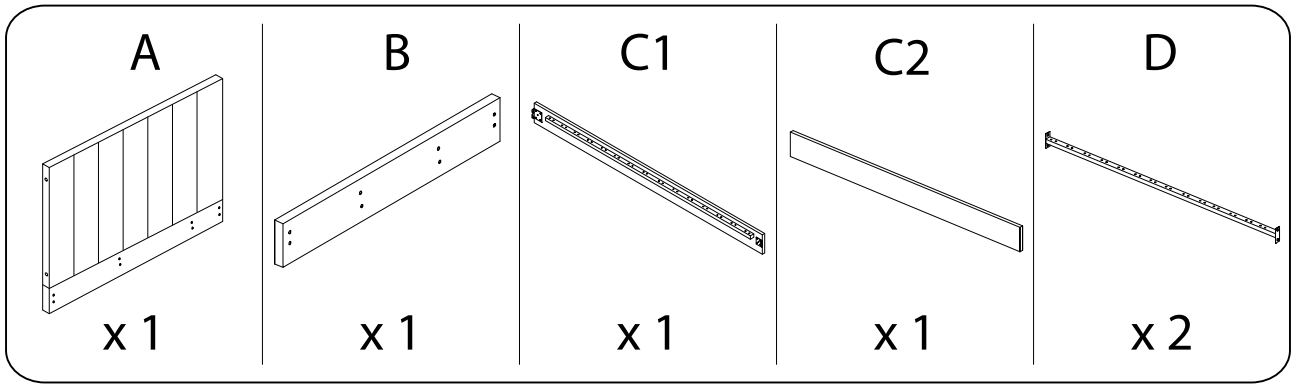

I

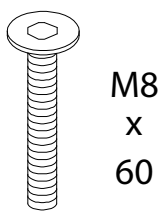

M8  
x  
60

x 4

J

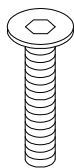

M8  
x  
40

x 16

K

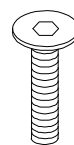

M8  
x  
30

x 8

L

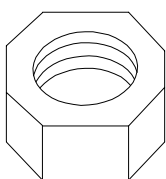

x 8

M

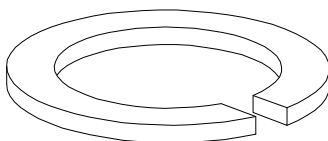

x 28

N

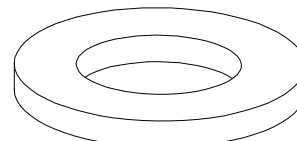

x 28

O

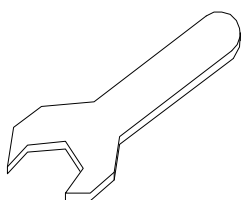

x 1

P

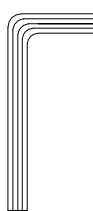

x 1

Q

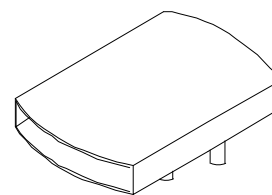

x 26

R

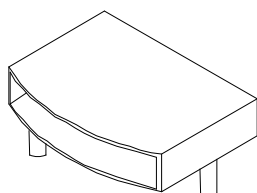

x 26

S

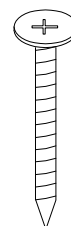

M4  
x  
25

x 8

1

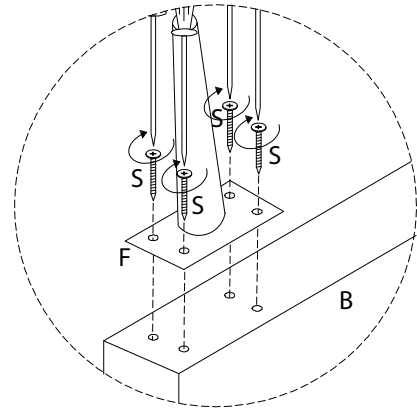
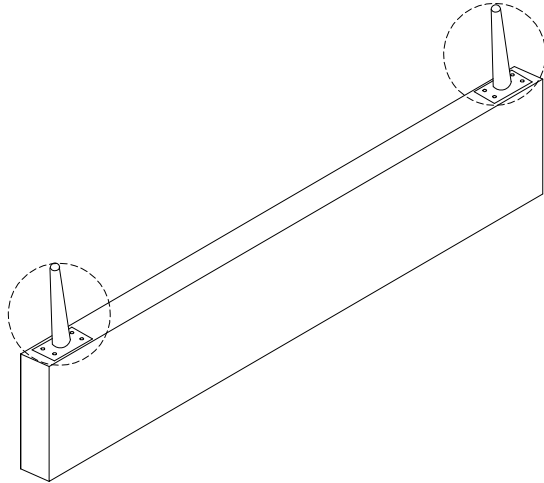
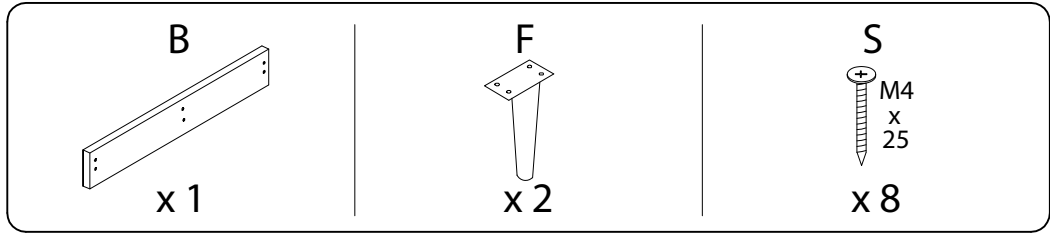

2

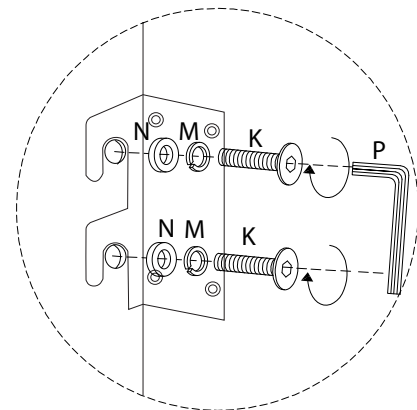
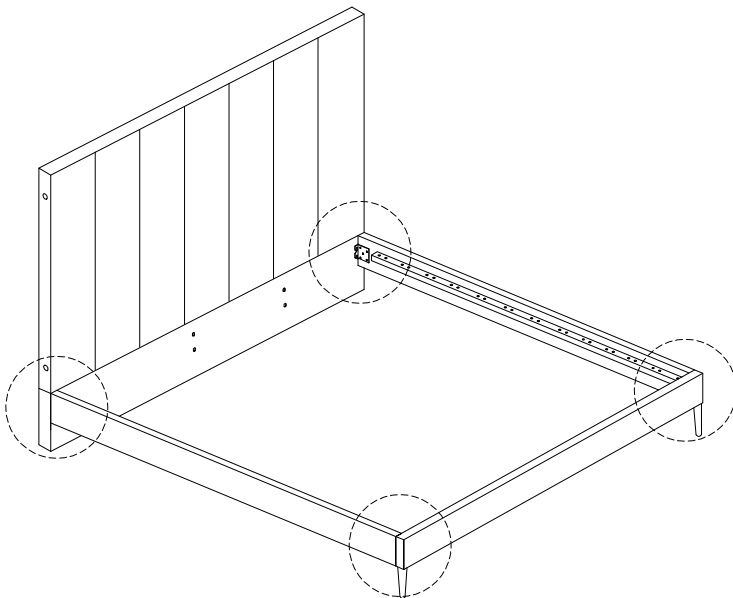
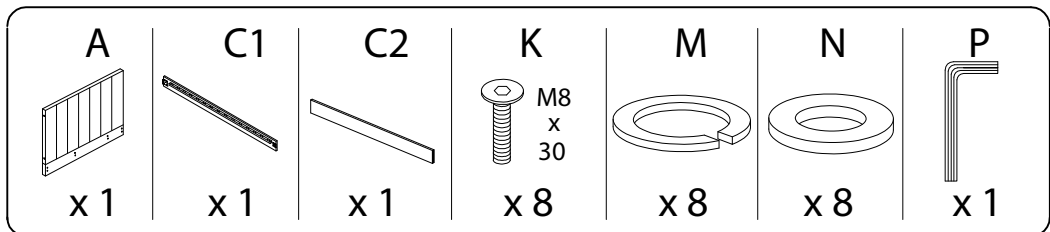

3

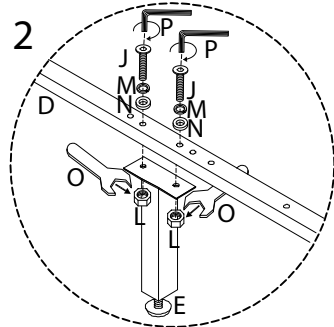
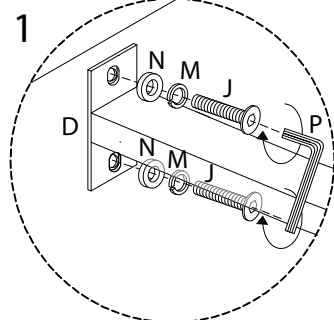
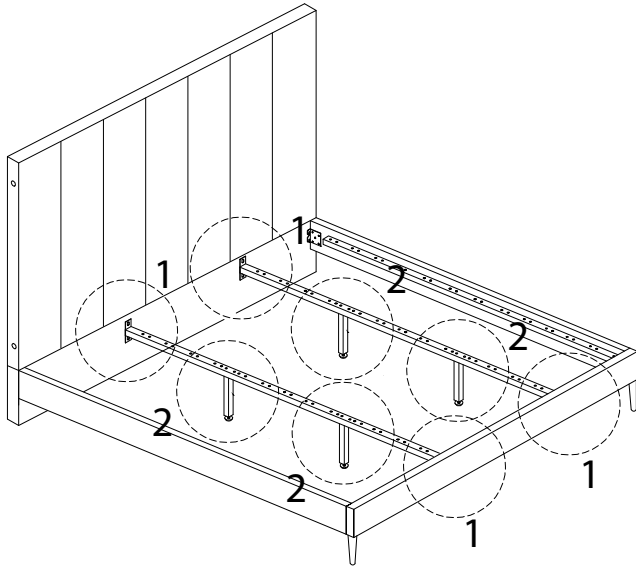
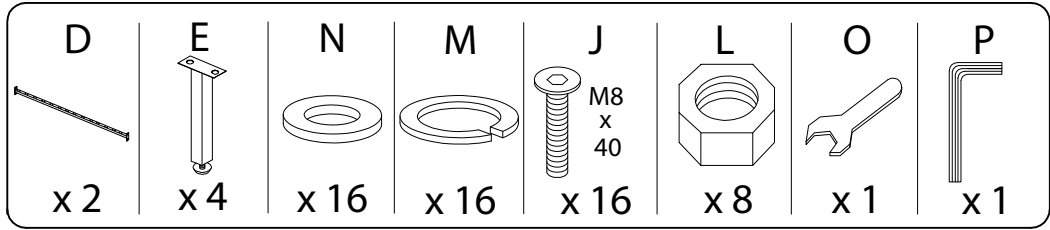

4

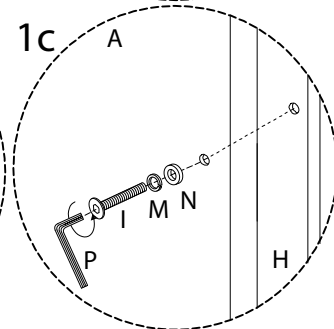
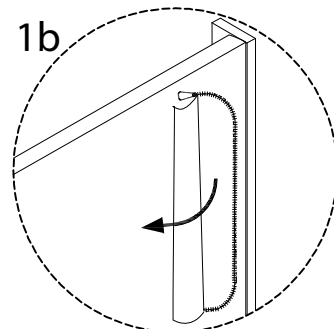
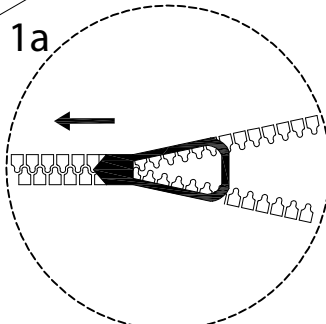
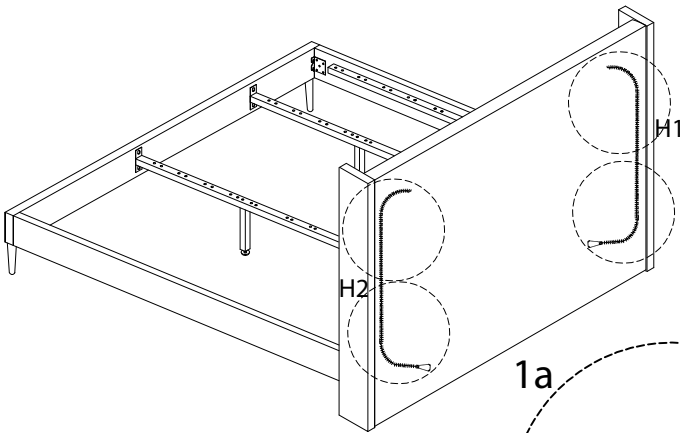
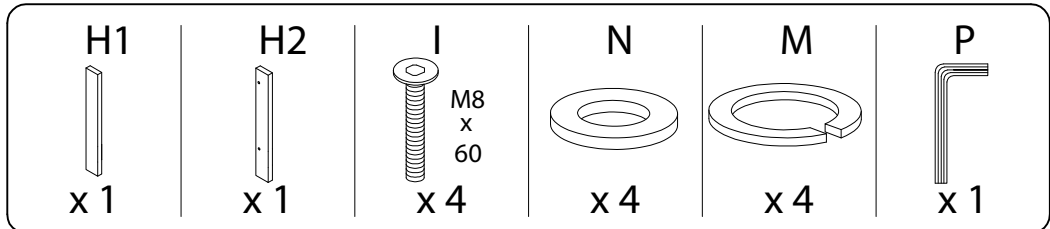

5 x13

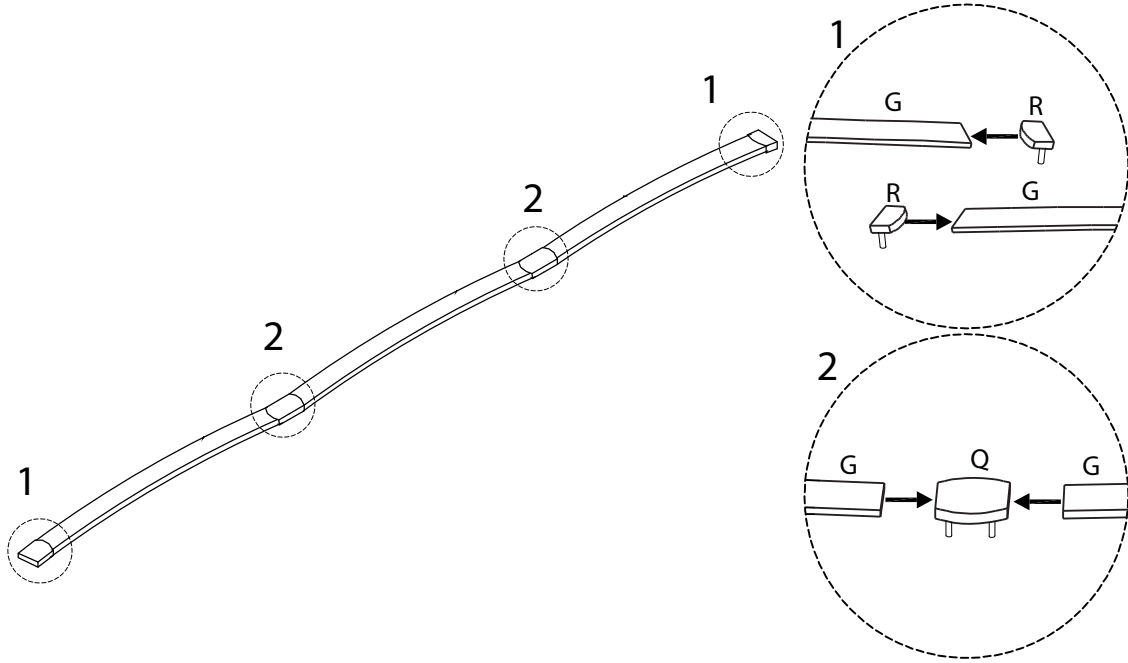
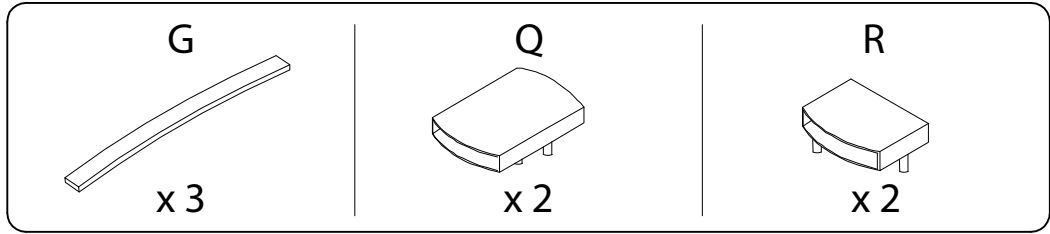

6 x13

