

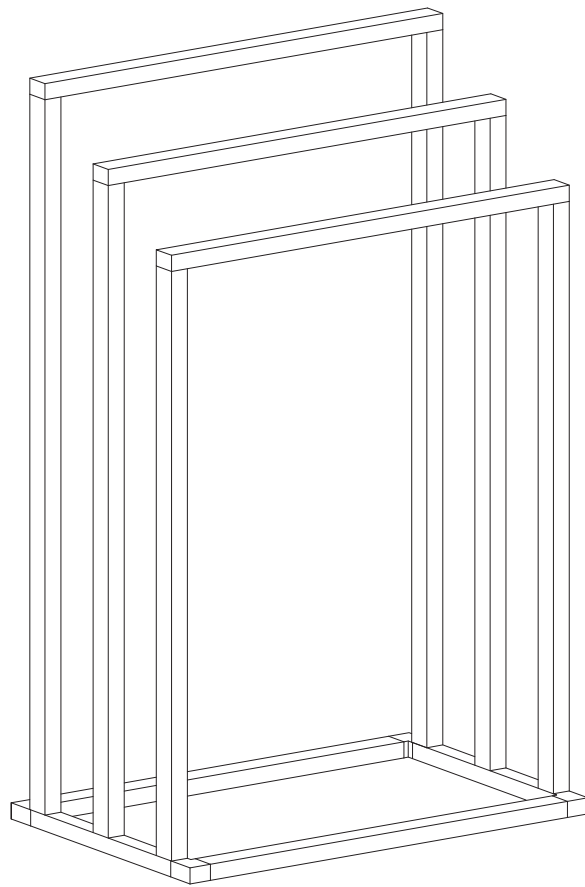

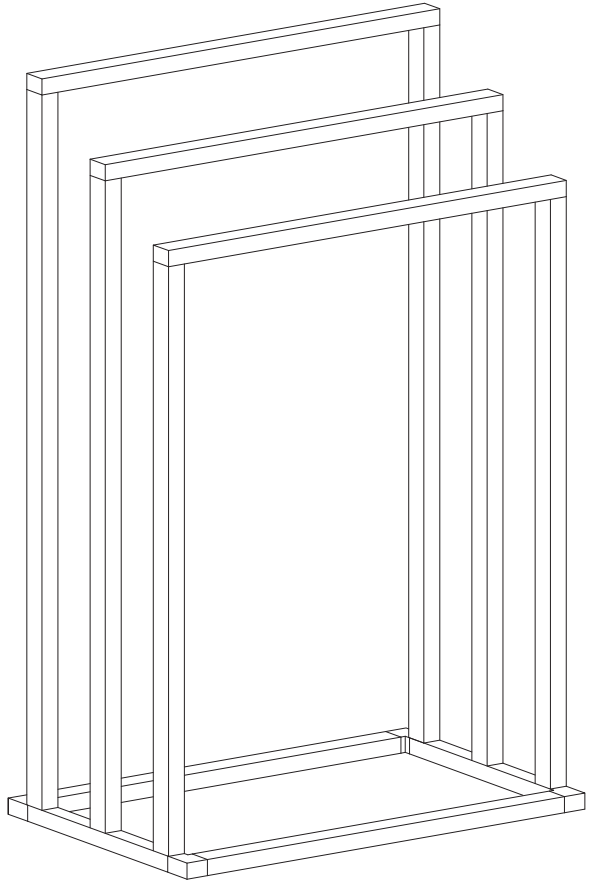

# CHARRAS

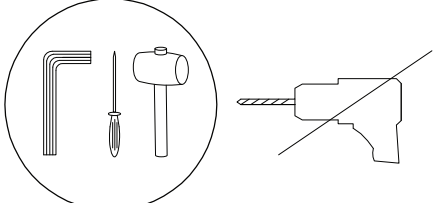



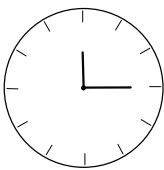
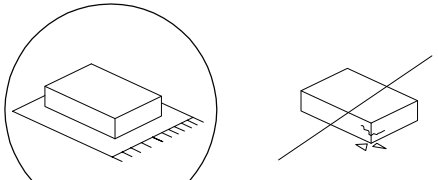

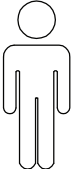
15'

1

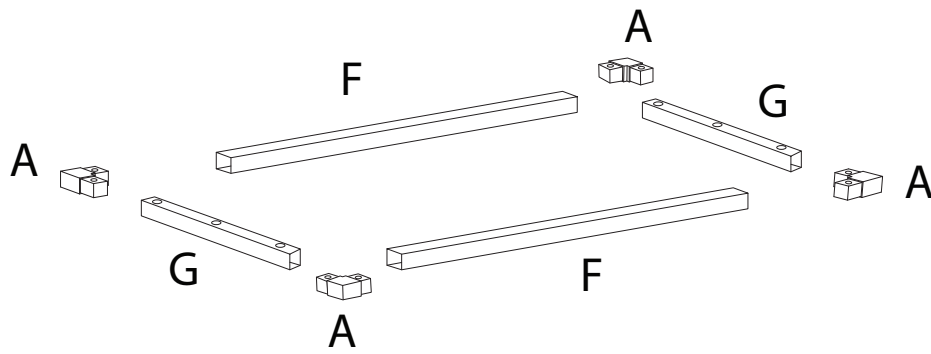
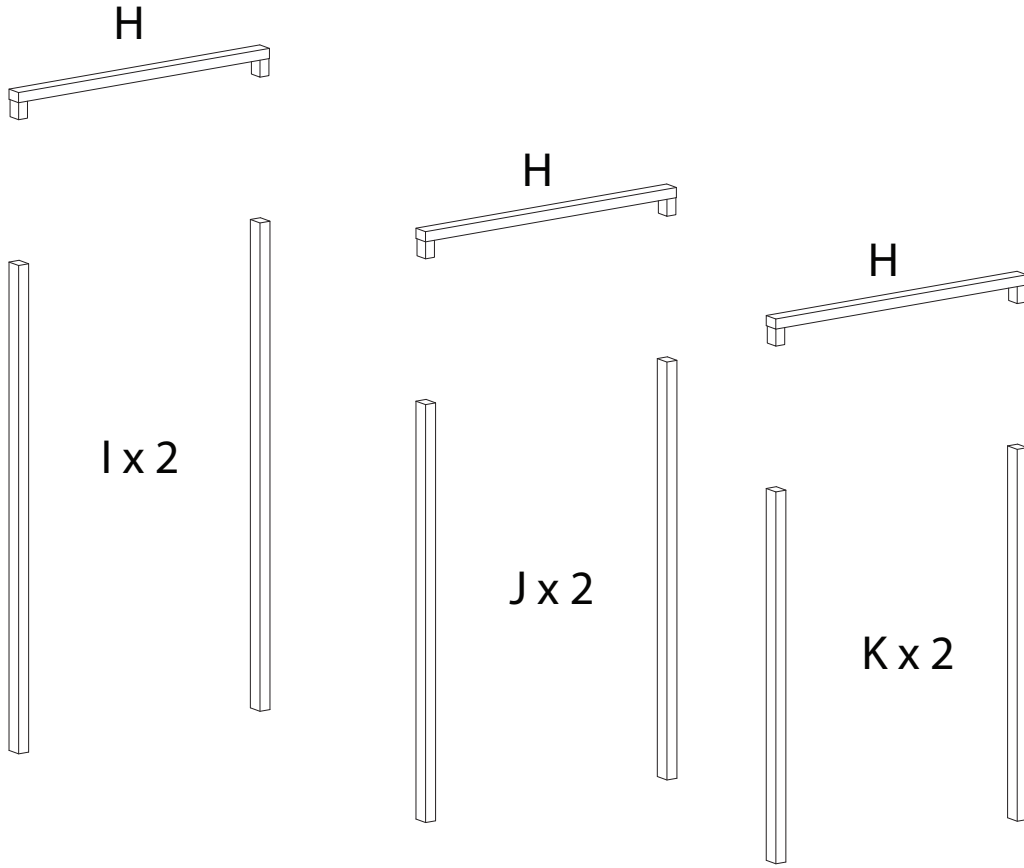

A

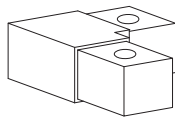

x 4

B



x 4

C

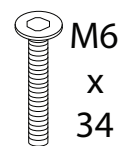

M6  
x  
34

x 6

D

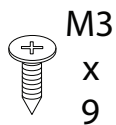

M3  
x  
9

x 6

E

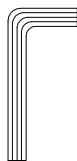

x 1

F

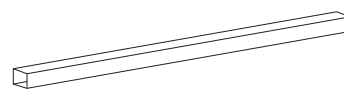

x 2

G

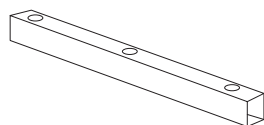

x 2

H

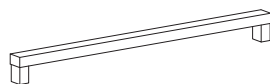

x 3

I



x 2

J



x 2

K



x 2

1

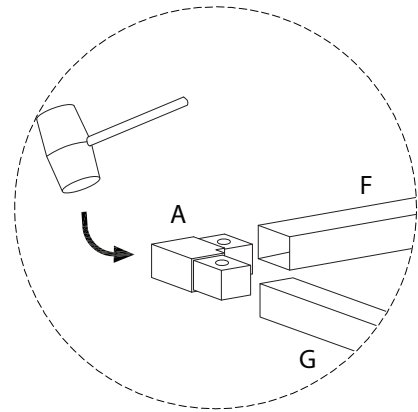
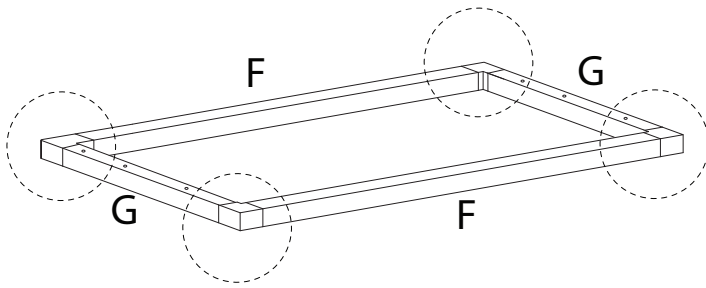
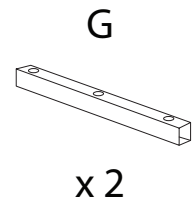
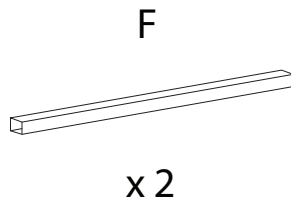
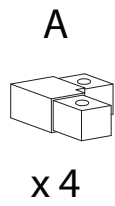

2

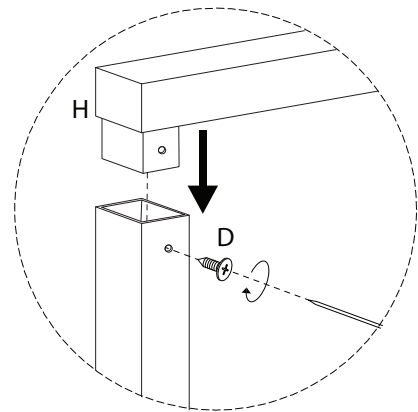
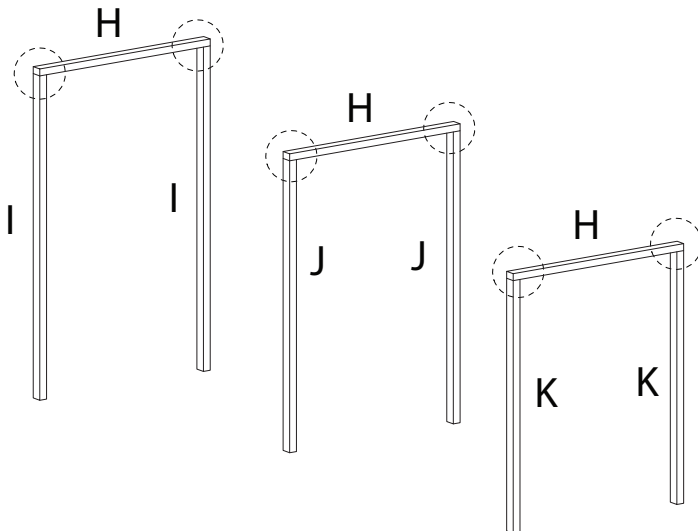
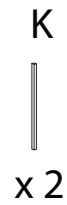
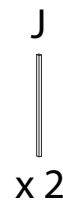
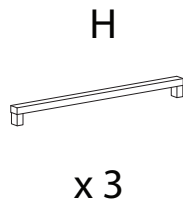
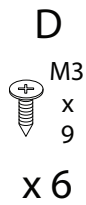

3

C  
M6  
x  
34  
x 6

E  
x 1

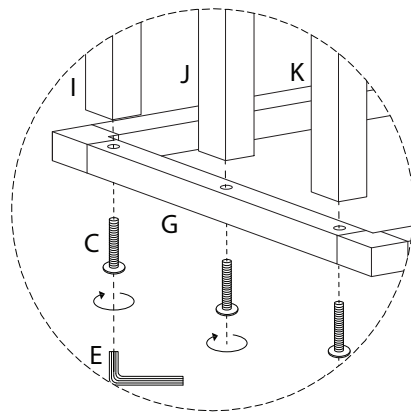
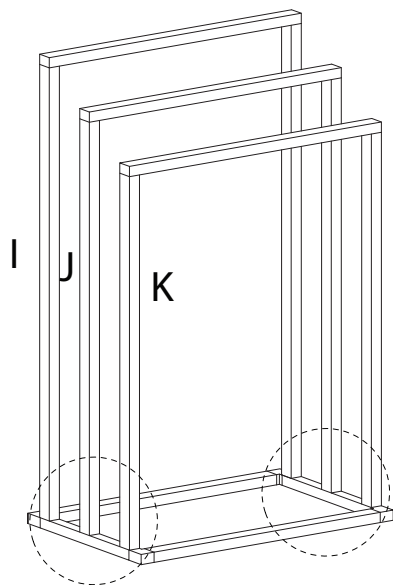

4

B



x 4

