

B x 2

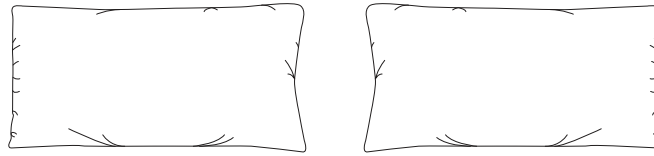

D x 2

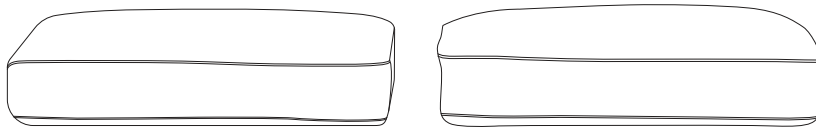

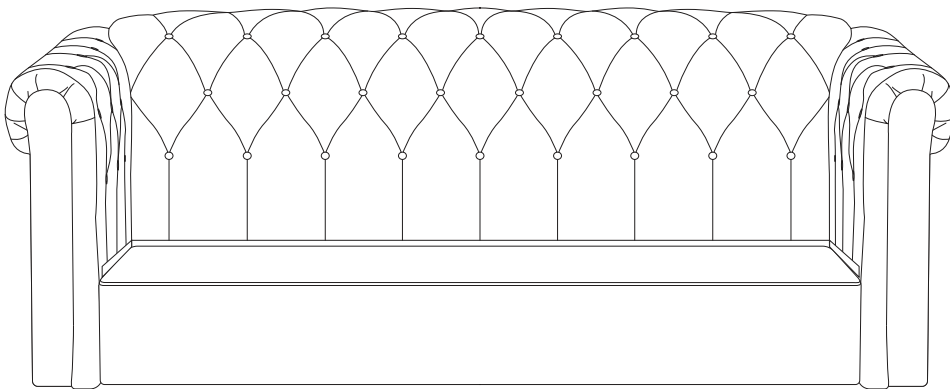

A



C x 4

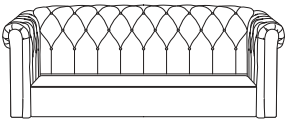

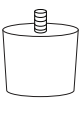
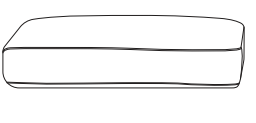
A	B	C	D
			
x 1	x 2	x 4	x 2

1

A

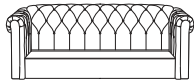

x 1

C



x 4

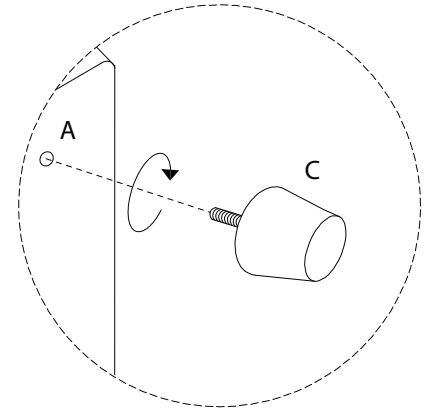
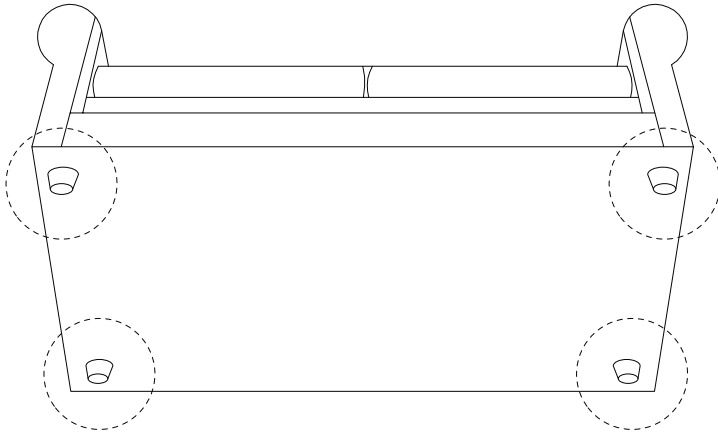

2

B



x 2

D

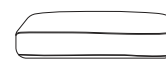

x 2

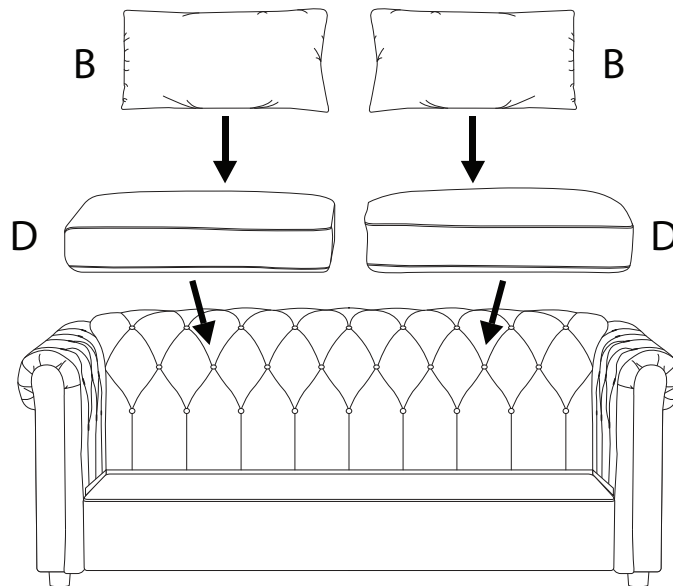

!

