

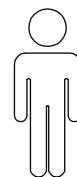

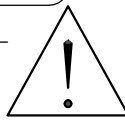

10'

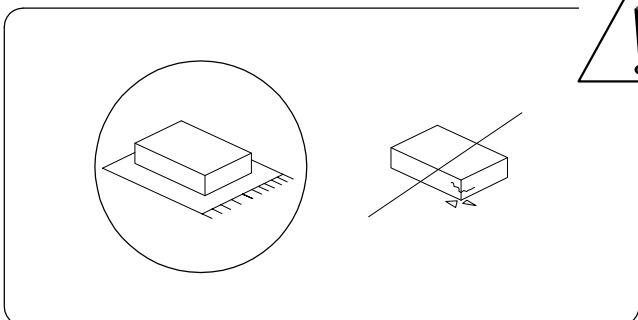

1

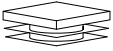
<p>A</p>  <p>x 2</p>	<p>B</p>  <p>x 2</p>	<p>C</p>  <p>x 1</p>	<p>D</p>  <p>x 1</p>
---	---	--	---

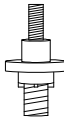
I



D



E

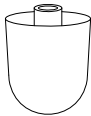

F

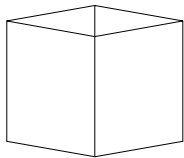

P



G

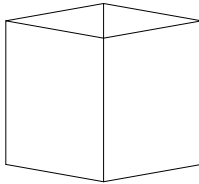

O

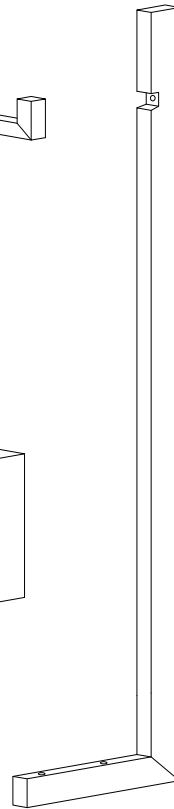

Q

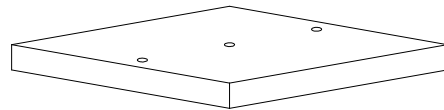

R

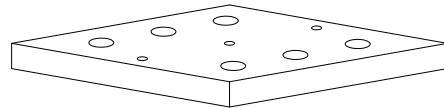

E

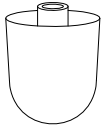

x 1

F

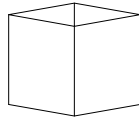

x 1

G

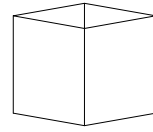

x 1

H

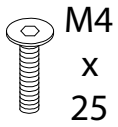

x 1

I



x 1

J

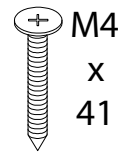

x 2

K

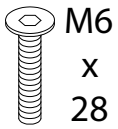

x 2

L

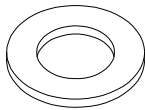

x 2

M

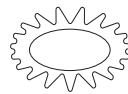

x 2

N

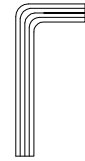

x 1

O

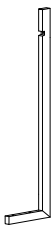

x 1

P



x 1

Q

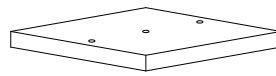

x 1

R

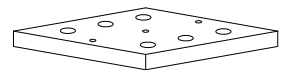

x 1

1

G



x 1

J

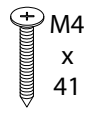

x 2

O



x 1

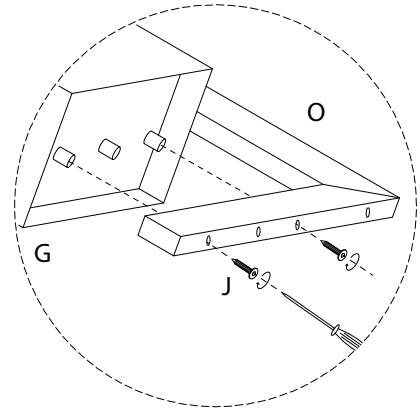
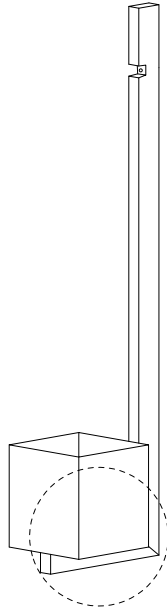

2

H



x 1

N

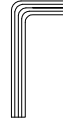

x 1

P



x 1

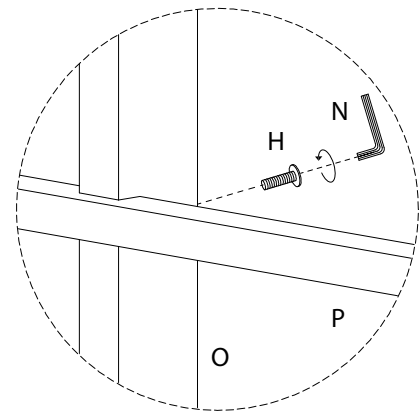
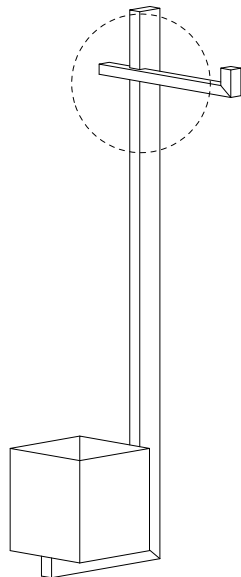

3

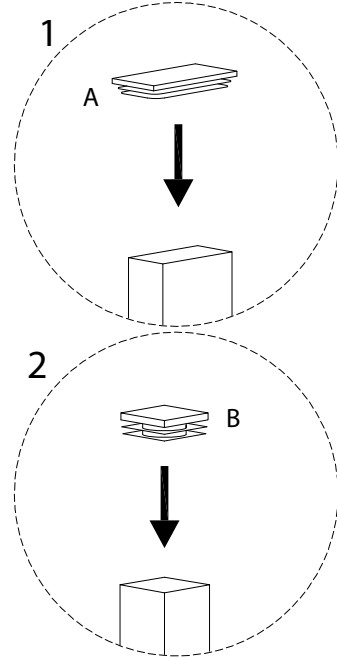
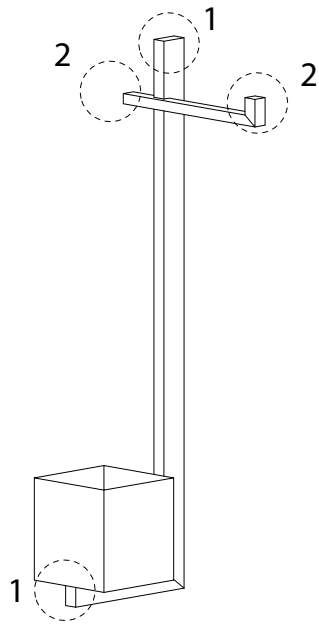
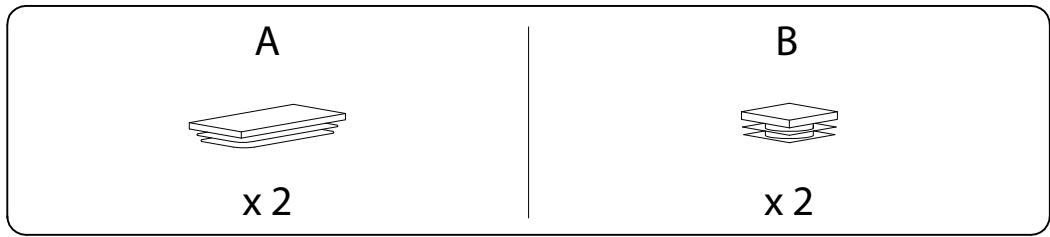

4

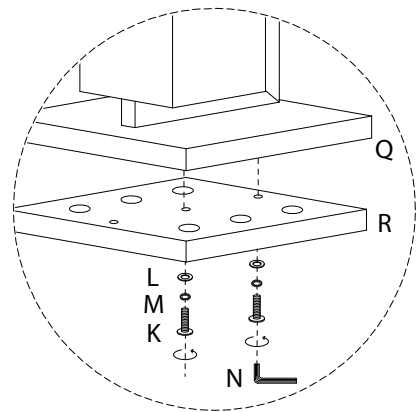
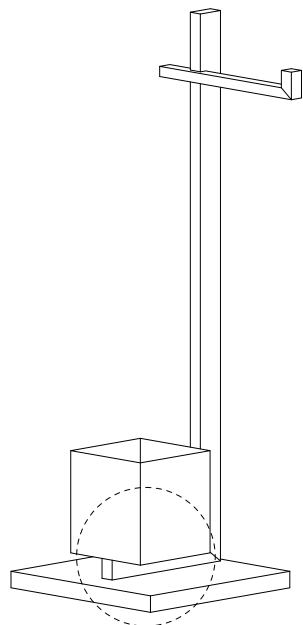
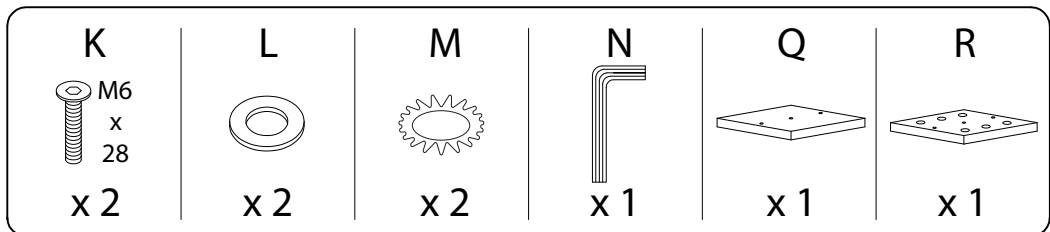

5

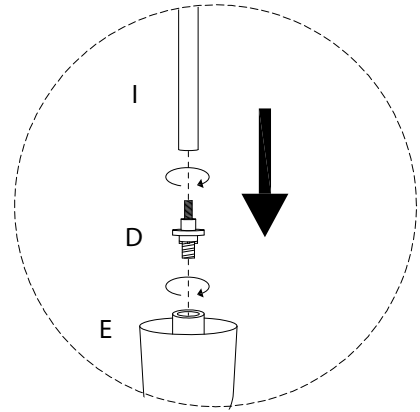
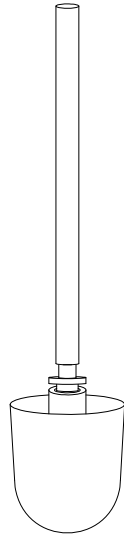
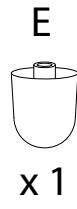
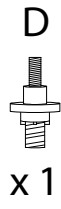

6

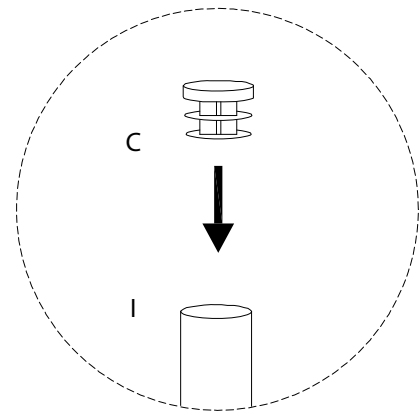
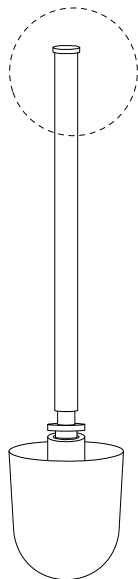
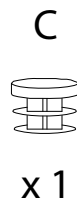

7

