

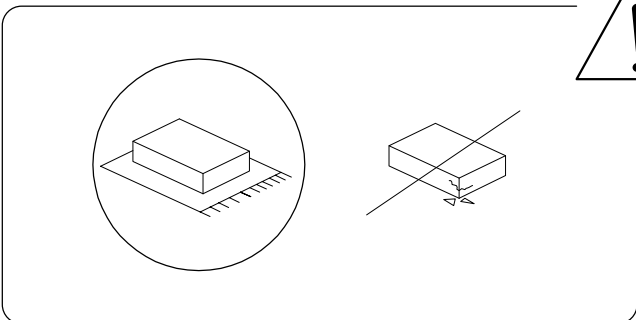

15'

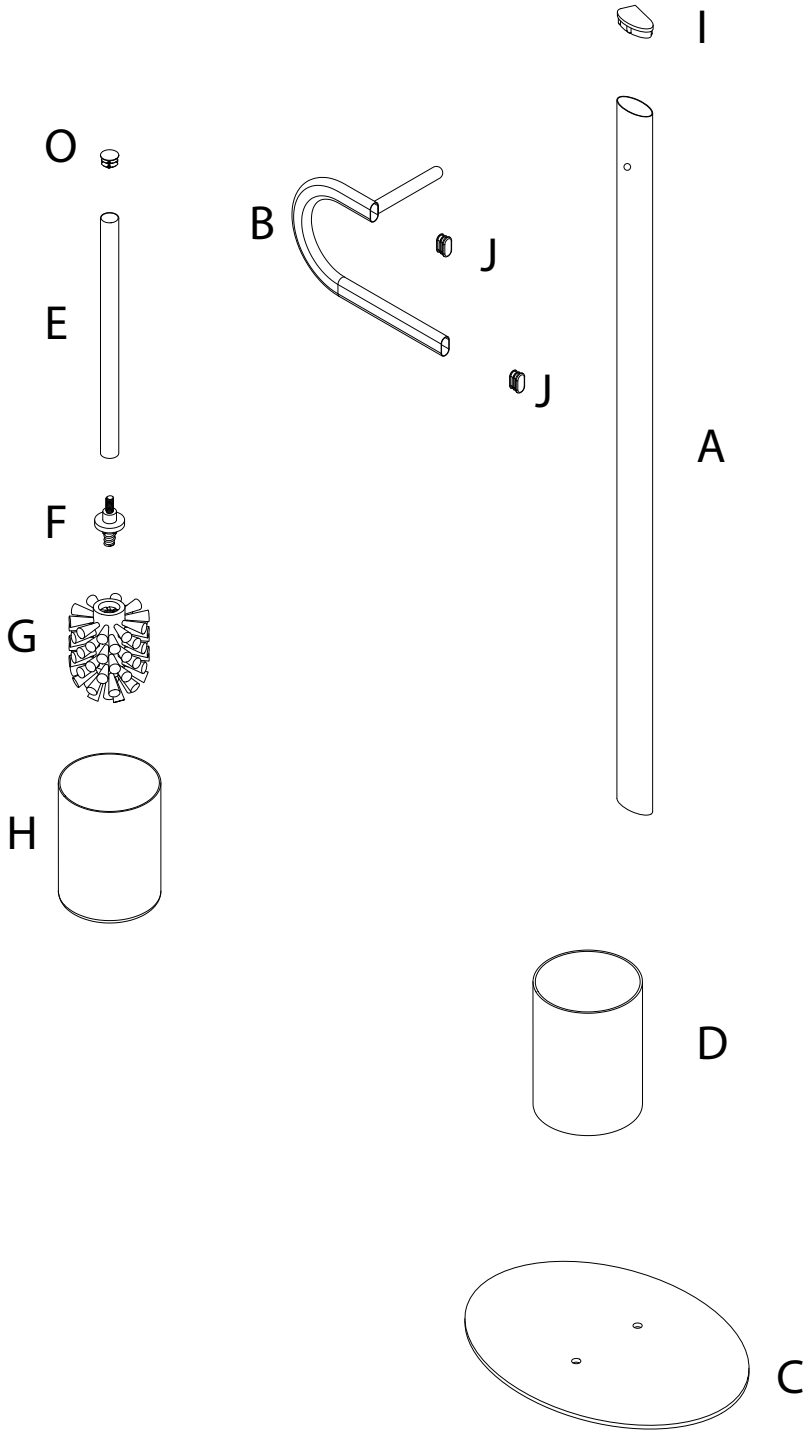

1

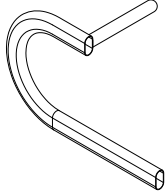
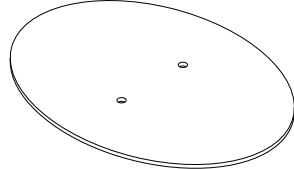

<p>A</p>  <p>x 1</p>	<p>B</p>  <p>x 1</p>	<p>C</p>  <p>x 1</p>
---	---	---

D

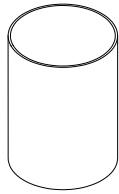

x 1

E



x 1

F

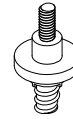

x 1

G



x 1

H

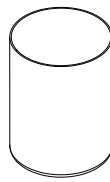

x 1

I

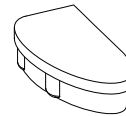

x 1

J

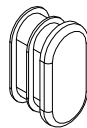

x 2

K

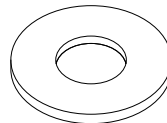

x 1

L

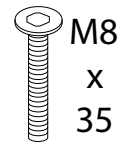

x 1

M

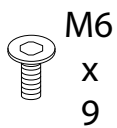

x 1

N



x 6

O



x 1

P

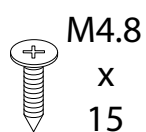

x 1

R

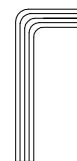

x 1

1

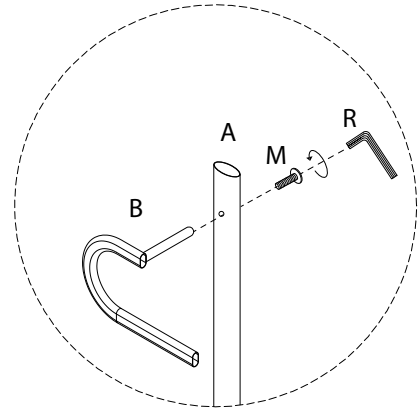
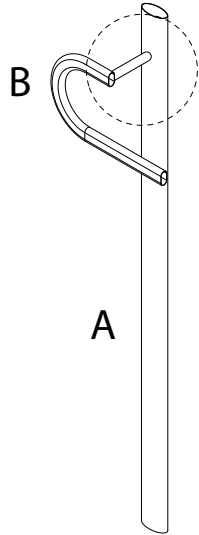
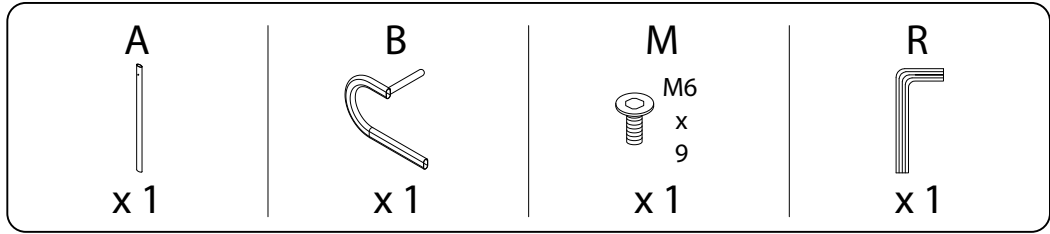

2

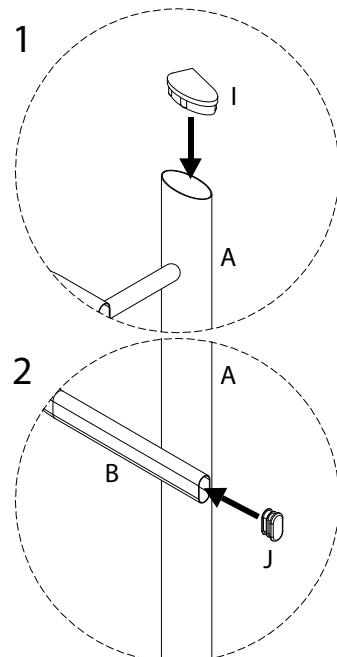
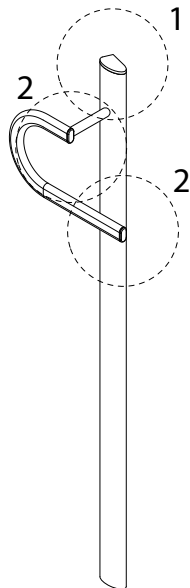
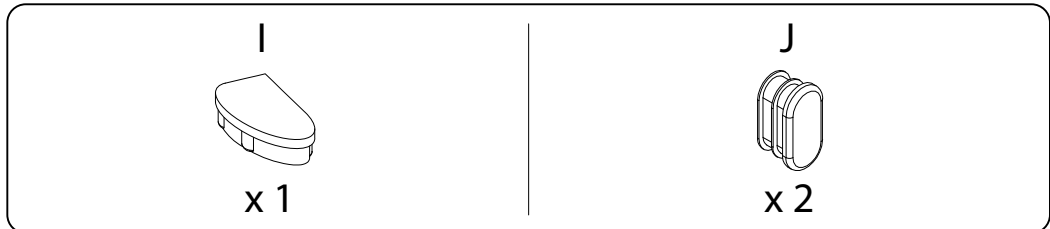

3

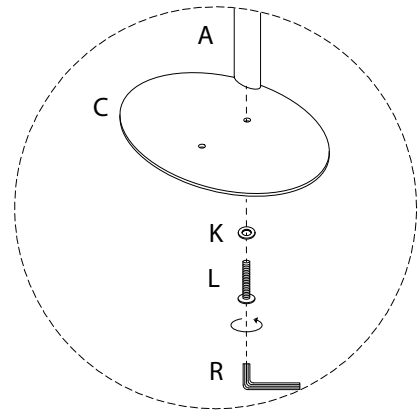
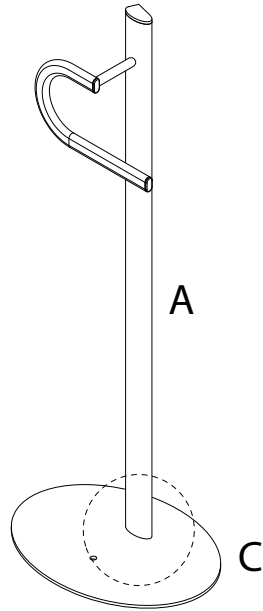
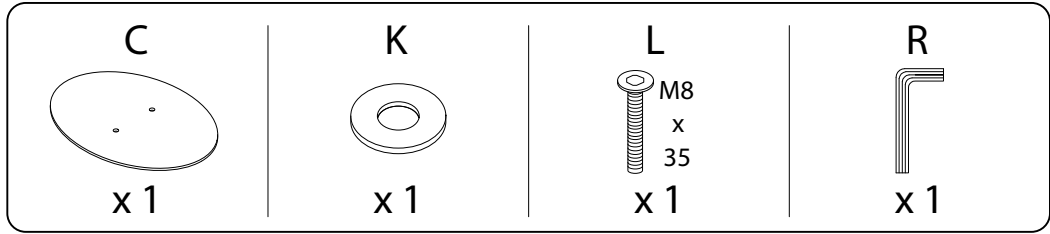

4

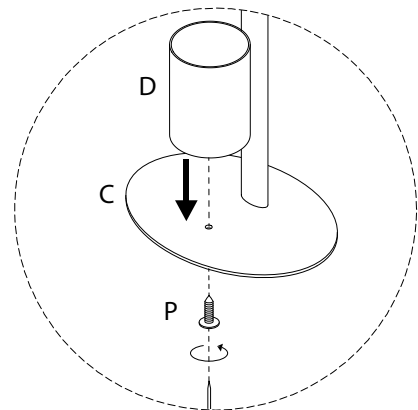
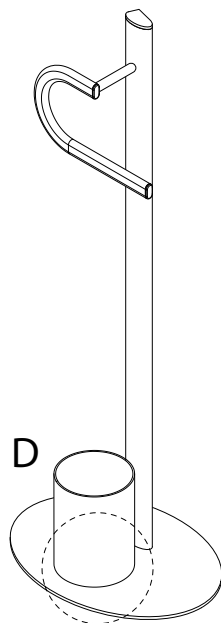
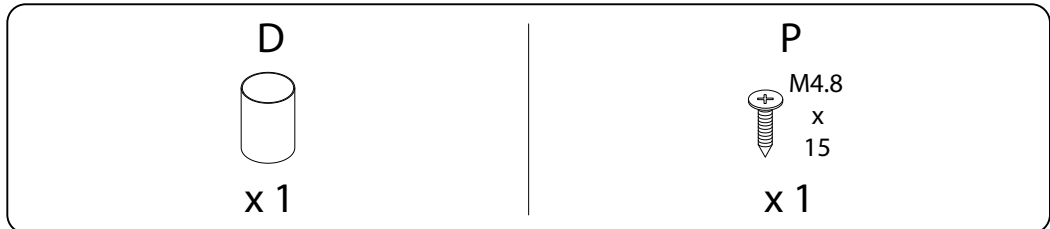

5

N



x 6

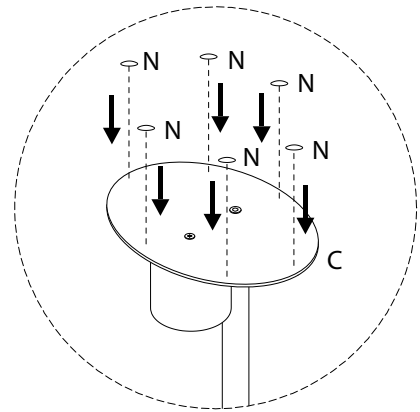
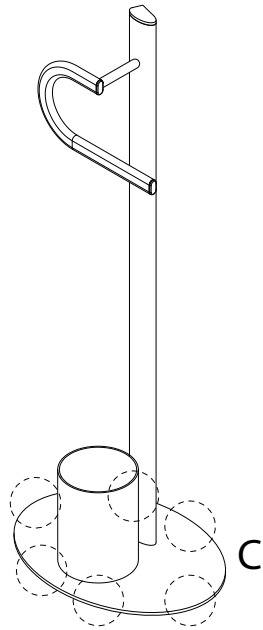

6

E



x 1

F



x 1

G



x 1

O



x 1

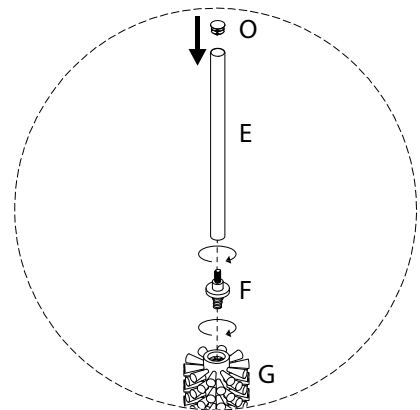
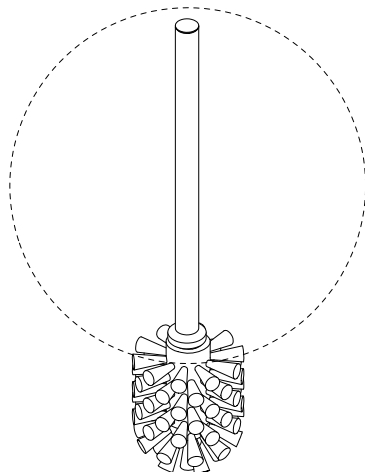

7

