

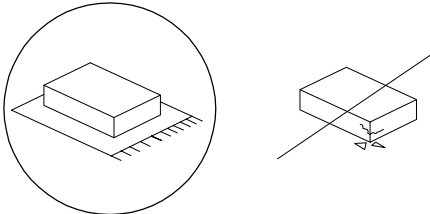

		<p>60'</p>
		
		<p>2</p>



E

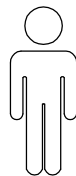
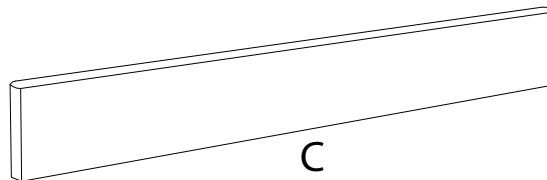
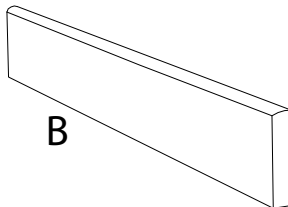
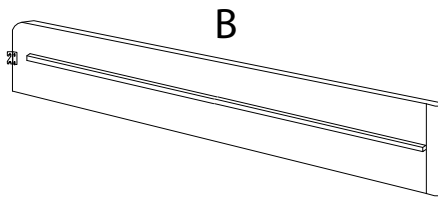
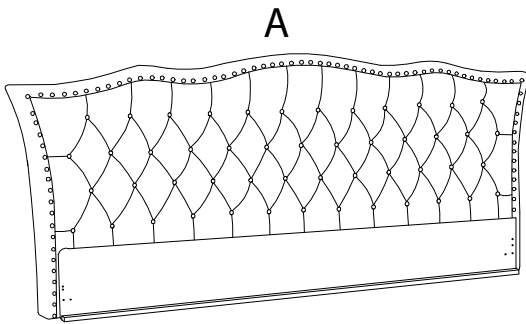
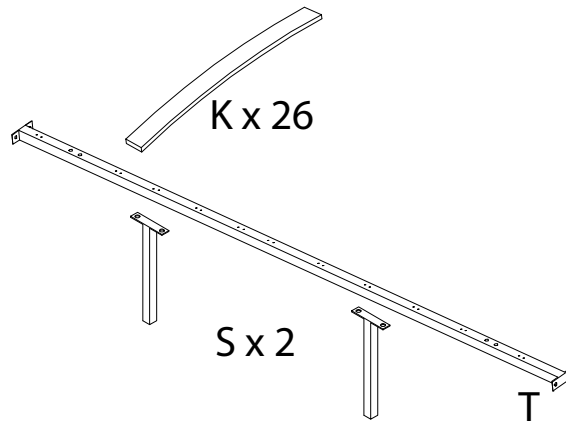
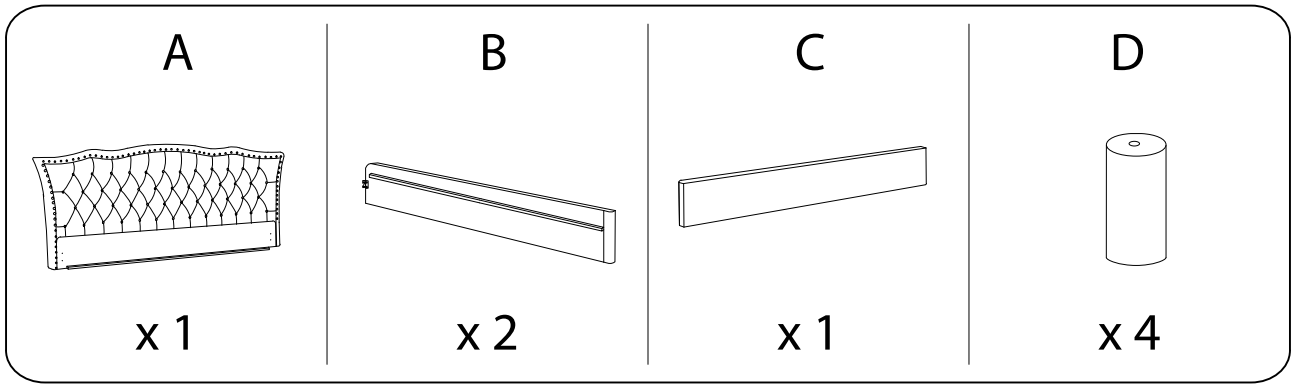
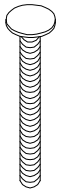

x 4

F

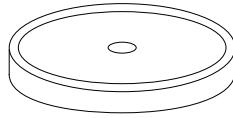

x 4

G

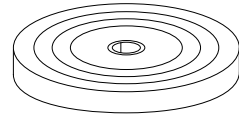

x 4

H

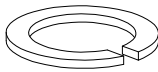

x 8

I

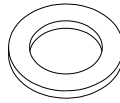

x 12

J

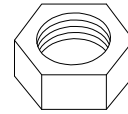

x 4

K

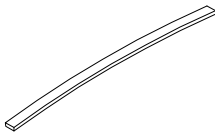

x 26

L

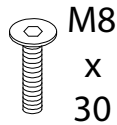

x 12

M

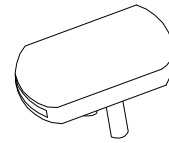

x 13

N

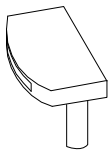

x 26

O

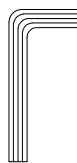

x 1

P

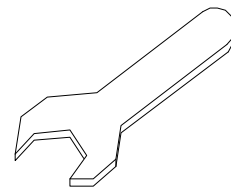

x 1

R

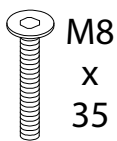

x 4

S

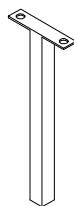

x 2

T

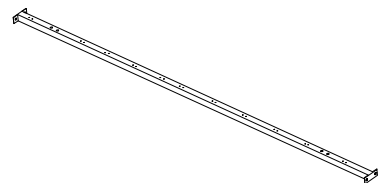

x 1

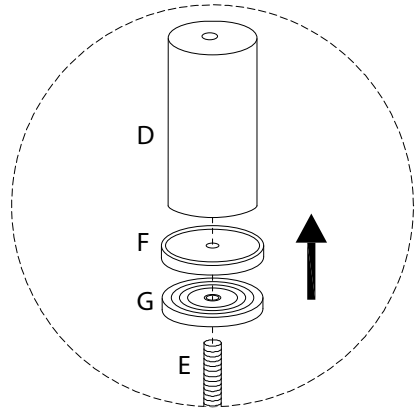
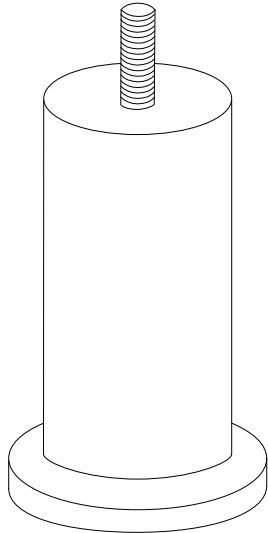
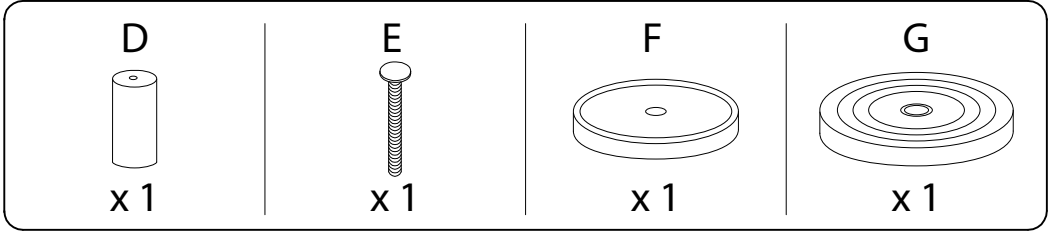

1 x 4

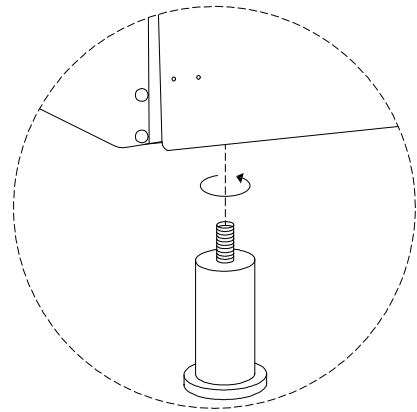
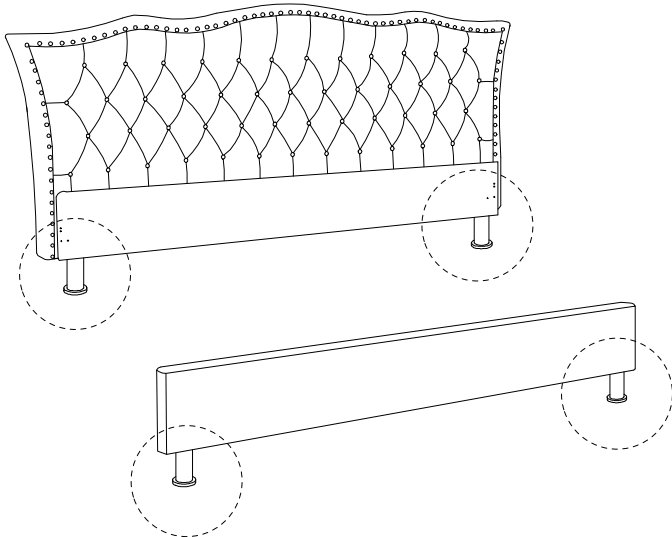
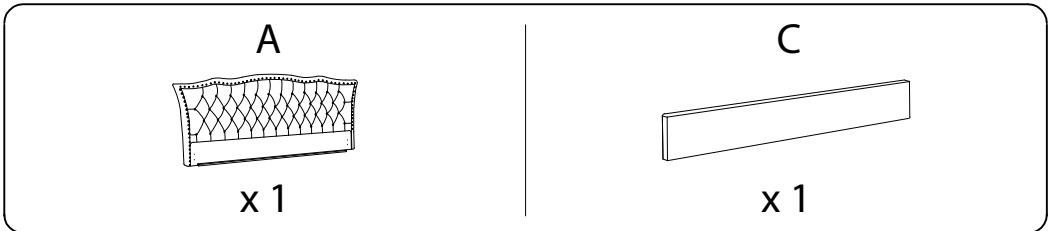

2



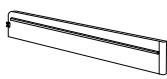
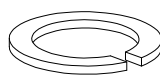
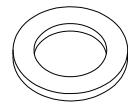

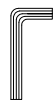
3

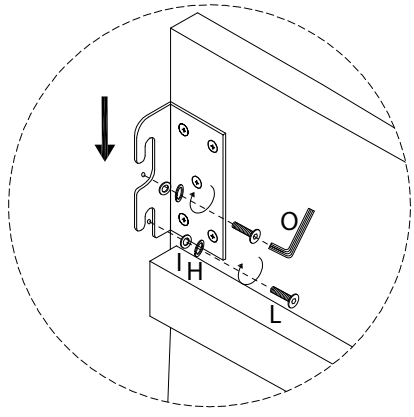
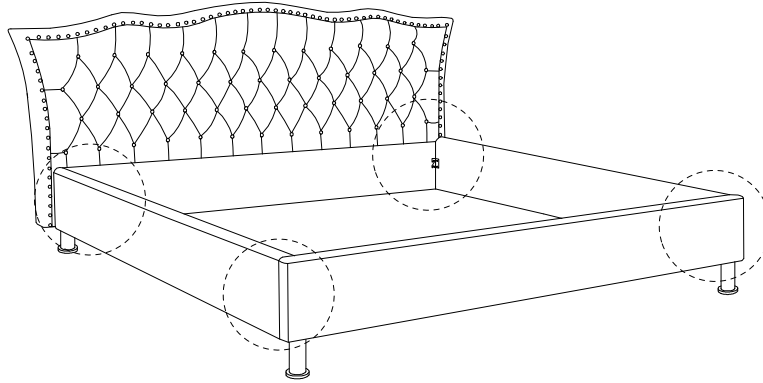
B  x 2	H  x 8	I  x 8	L  M8 x 30 x 8	O  x 1
--	--	--	--	--

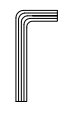
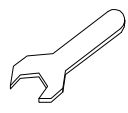
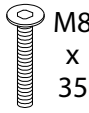
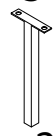
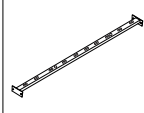

4

I  x 4	J  x 4	O  x 1	P  x 1	R  M8 x 35 x 4	S  x 2	T  x 1
--	--	--	--	---	--	--

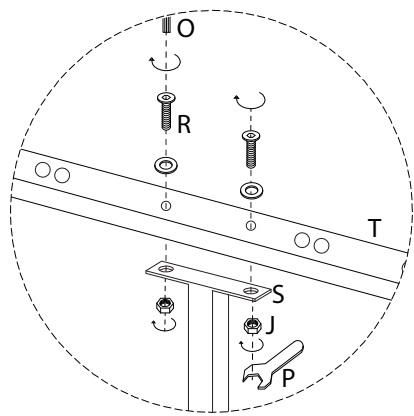
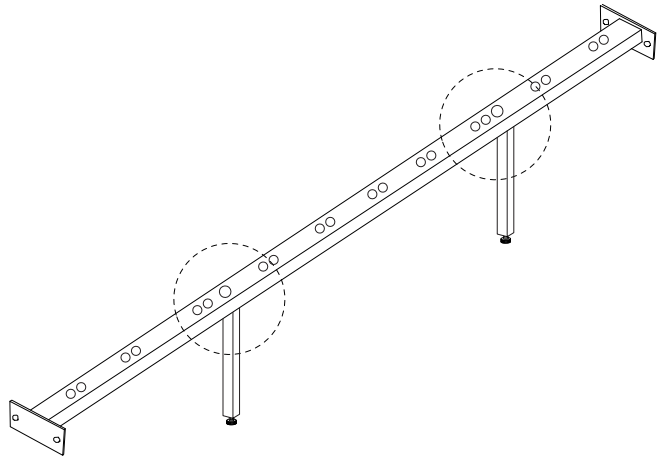

5

L

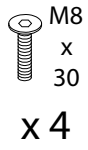

O

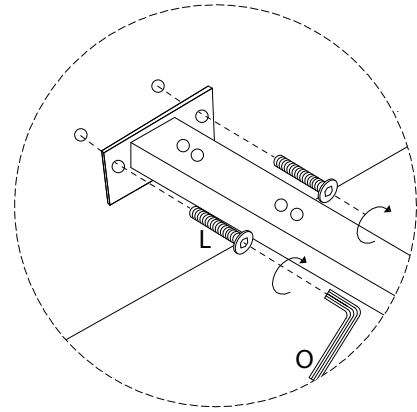
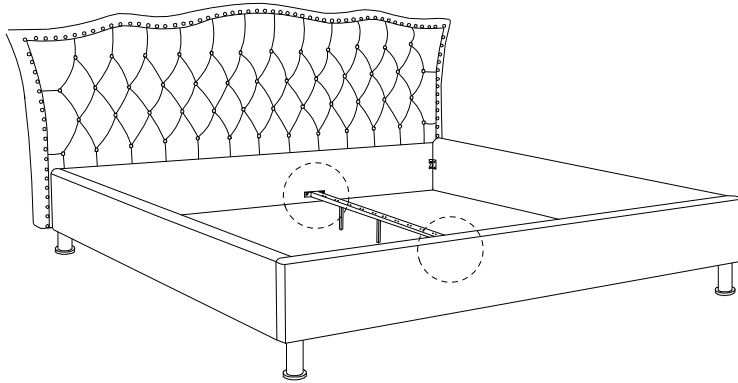

6 x 13

K

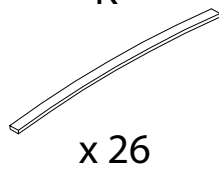

M

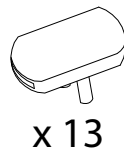

N

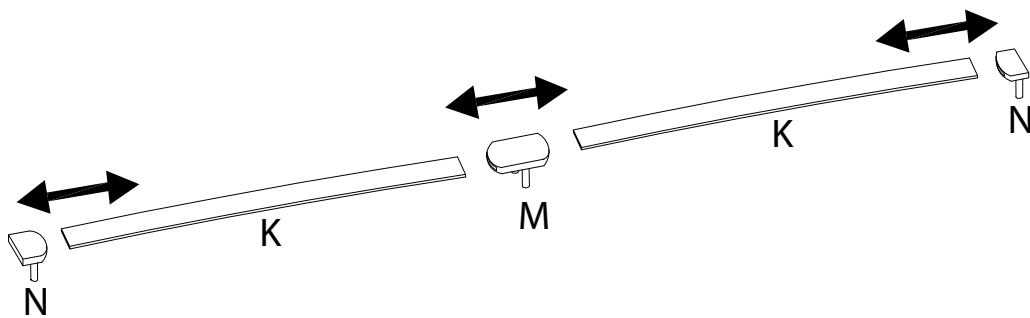

7 x 13

