

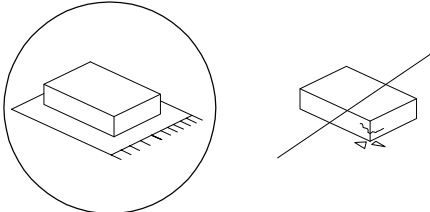

		60'
		
		2

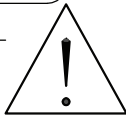
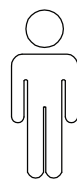
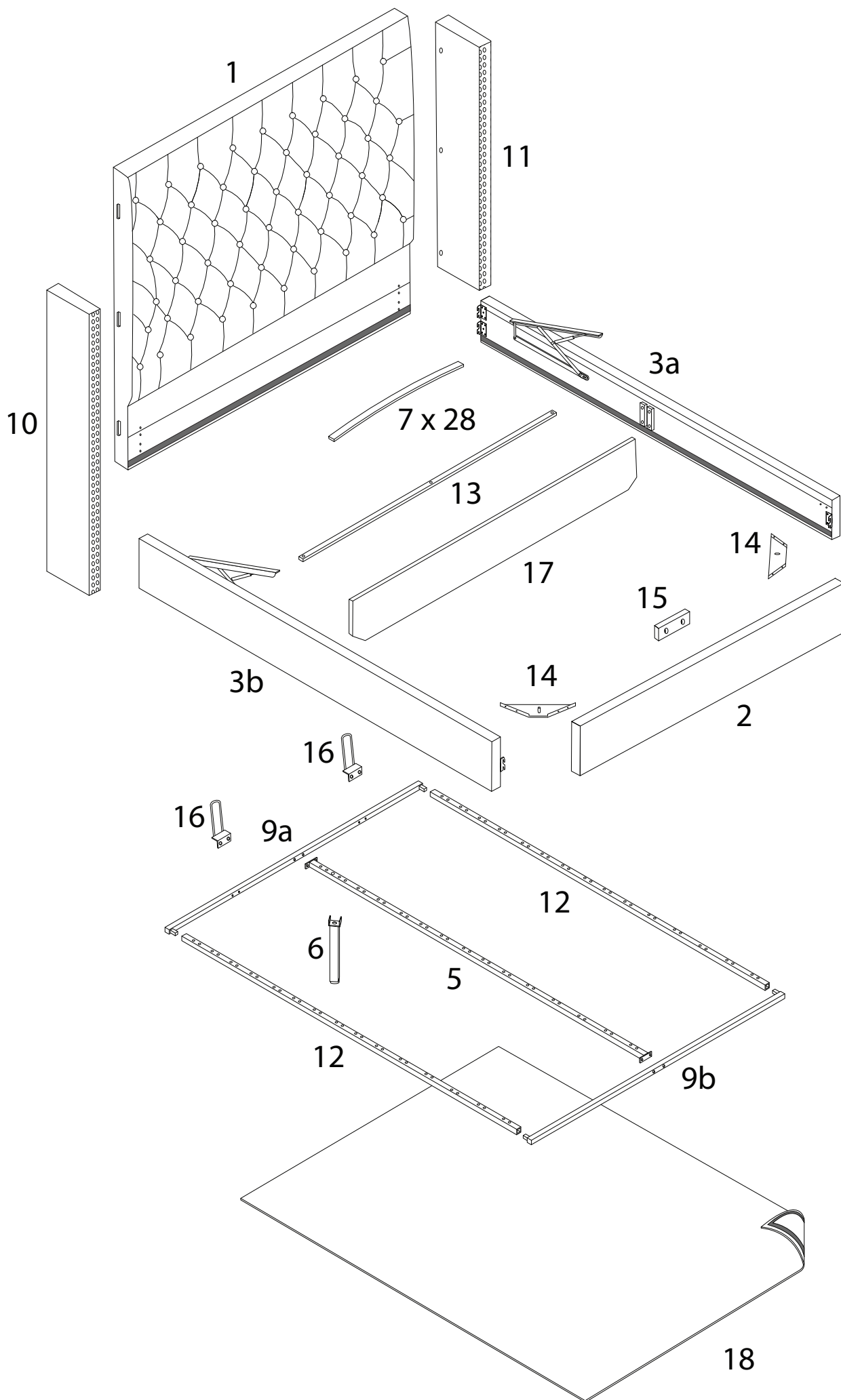
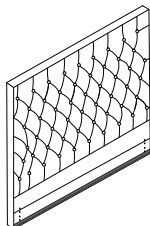
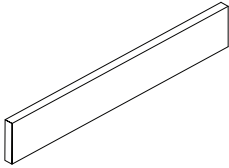
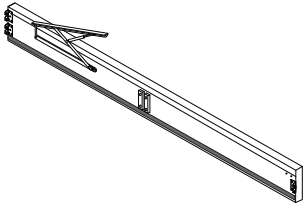
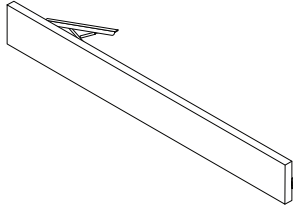
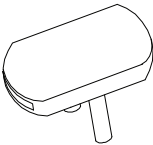
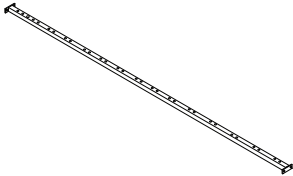

<p>1</p>  <p>x 1</p>	<p>2</p>  <p>x 1</p>	<p>3a</p>  <p>x 1</p>	<p>3b</p>  <p>x 1</p>
<p>4</p>  <p>x 14</p>	<p>5</p>  <p>x 1</p>	<p>6</p>  <p>x 1</p>	<p>7</p>  <p>x 28</p>
<p>8</p>  <p>x 28</p>	<p>9a</p>  <p>x 1</p>	<p>9b</p>  <p>x 1</p>	<p>10</p>  <p>x 1</p>
<p>11</p>  <p>x 1</p>	<p>12</p>  <p>x 2</p>	<p>13</p>  <p>x 1</p>	<p>14</p>  <p>x 2</p>
<p>15</p>  <p>x 1</p>	<p>16</p>  <p>x 2</p>	<p>17</p>  <p>x 1</p>	<p>18</p>  <p>x 1</p>

A

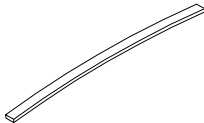
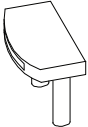
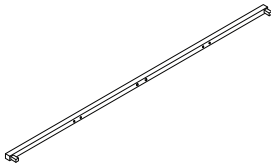
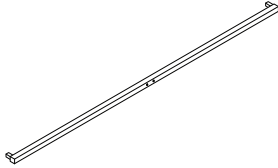
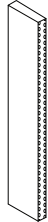
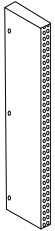
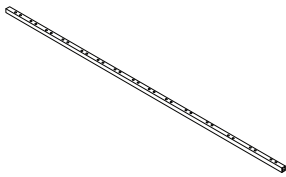
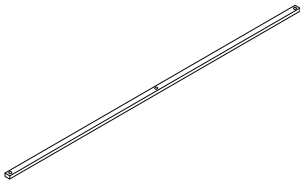
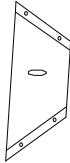
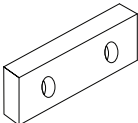
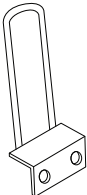
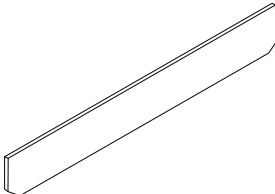
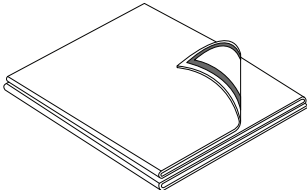
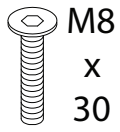

x 21

B

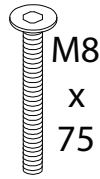

x 6

C

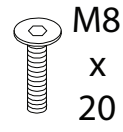

x 4

D

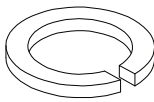

x 12

E

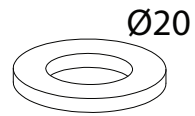

x 53

F

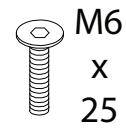

x 4

G

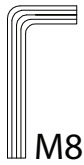

x 1

H

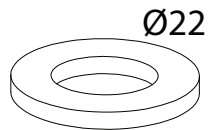

x 6

I

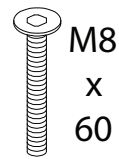

x 15

J

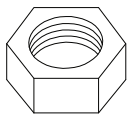

x 15

K

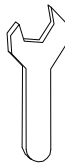

x 1

L



x 1

1

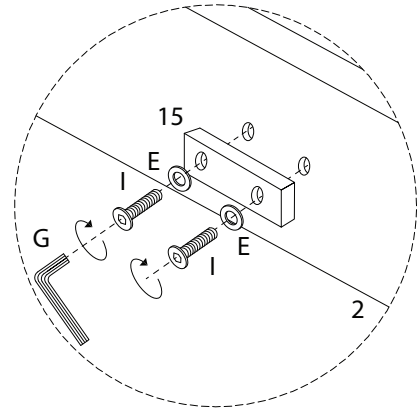
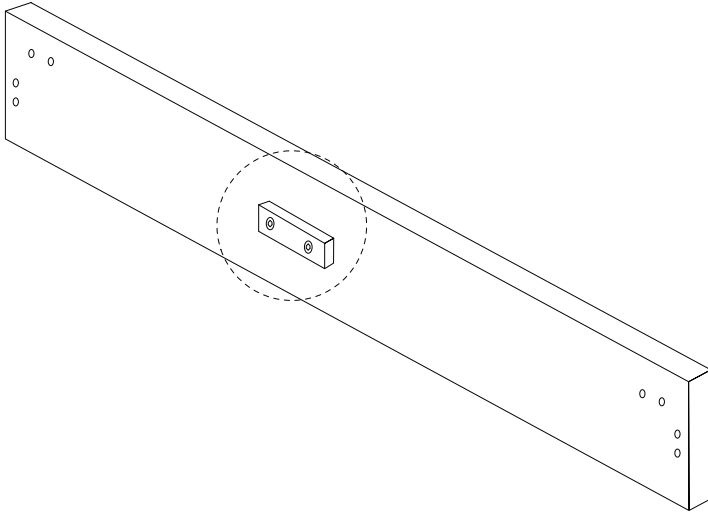
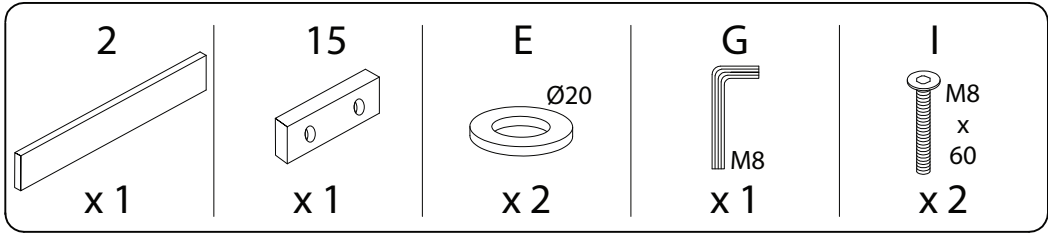

2

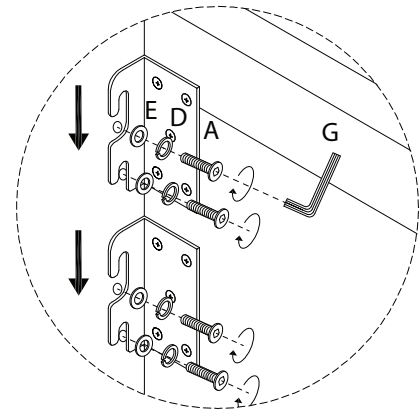
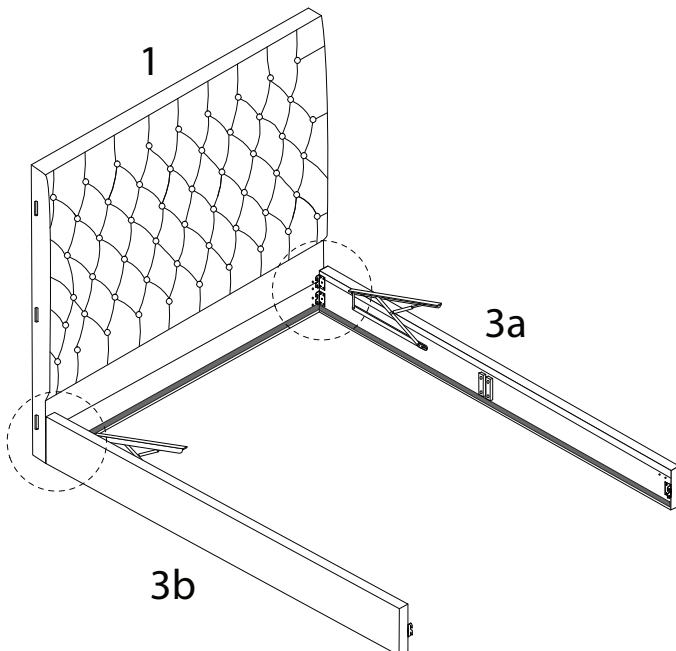
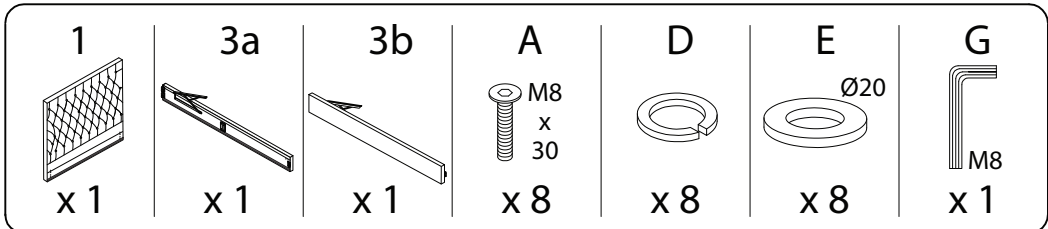

3

A



x 4

D



x 4

E



x 4

G



x 1

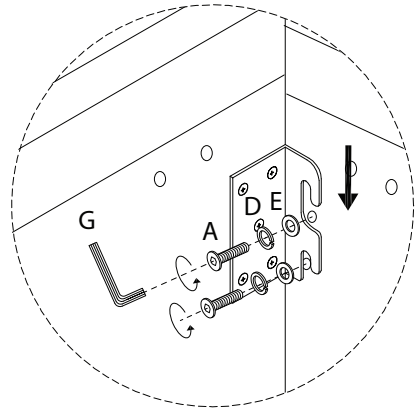
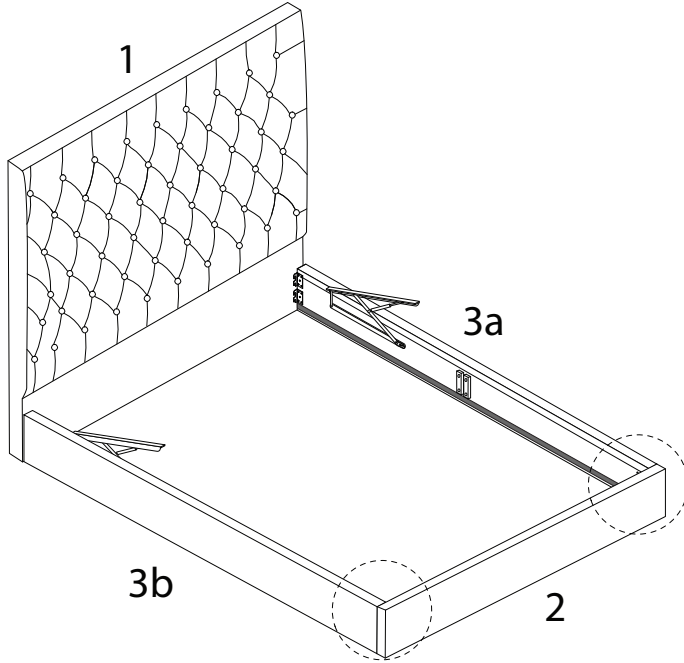

4

14

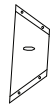

x 2

A



x 8

E

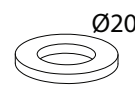

x 8

G



x 1

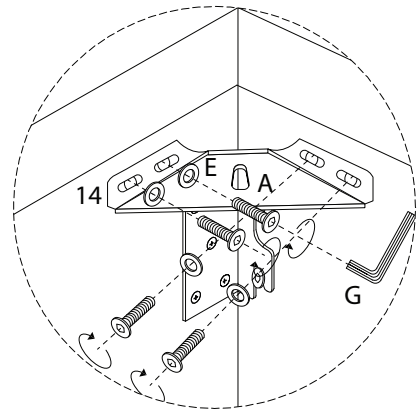
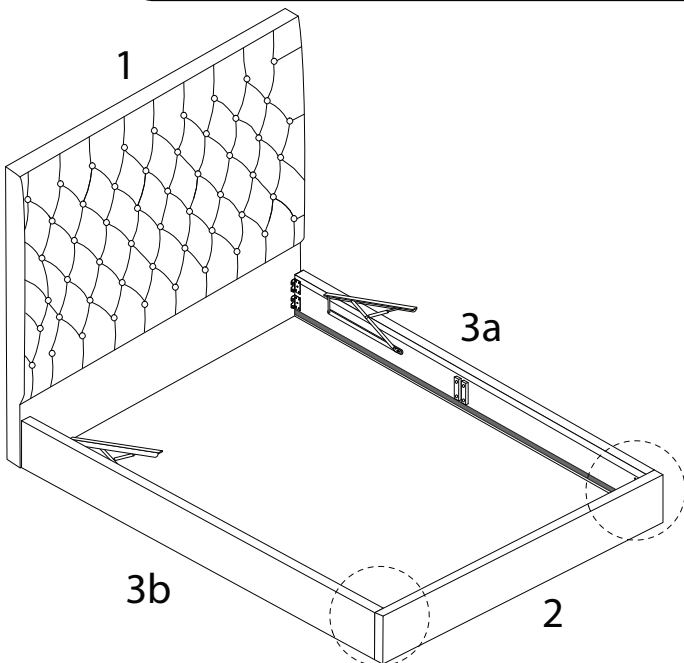

5

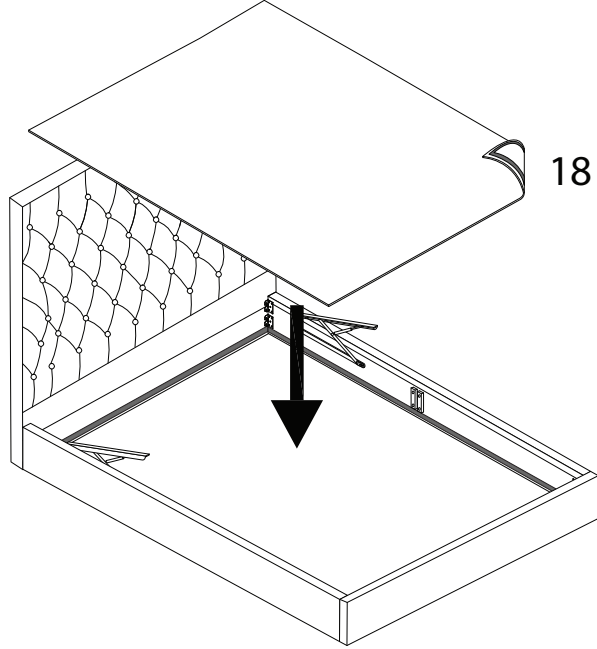
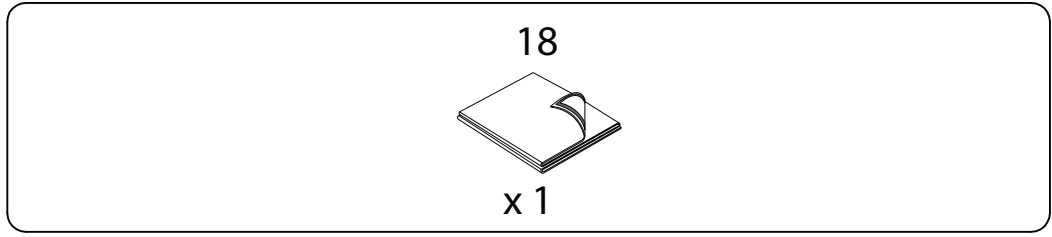

6

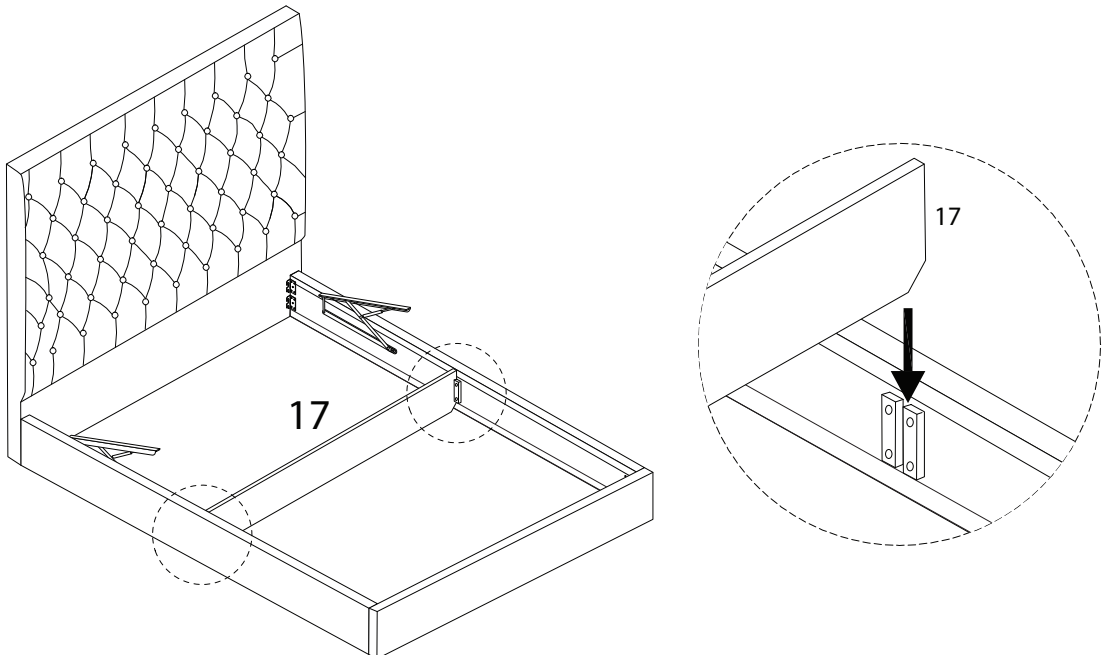
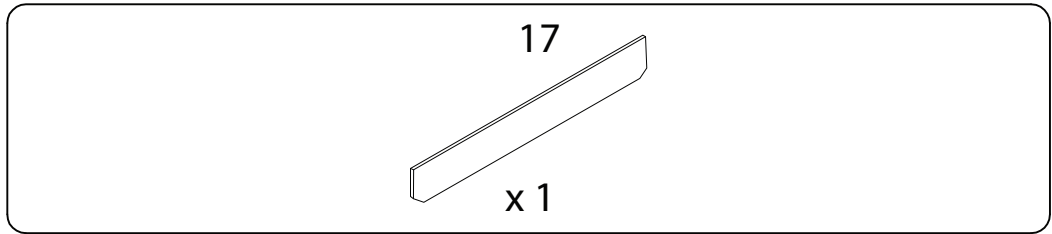

7

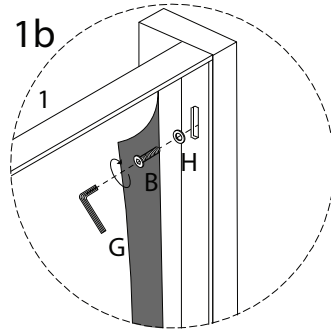
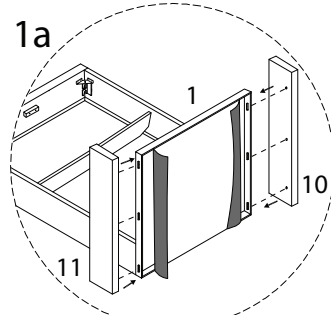
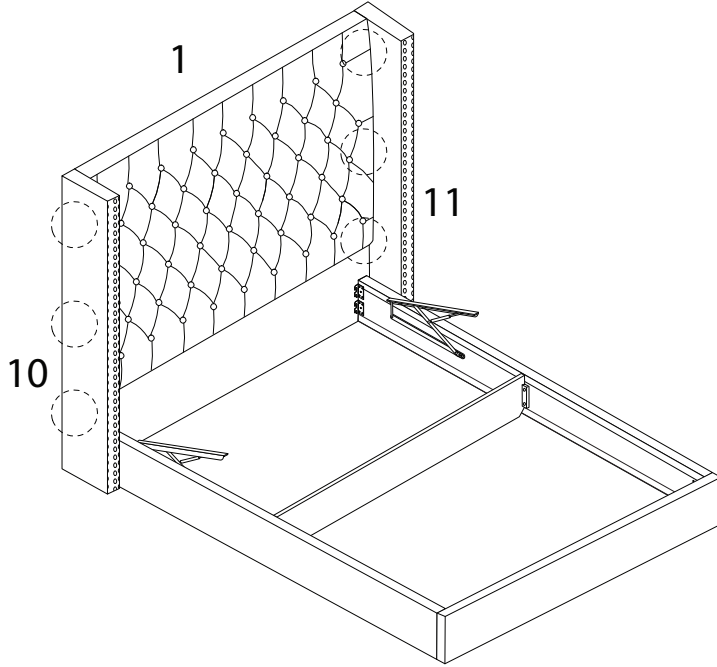
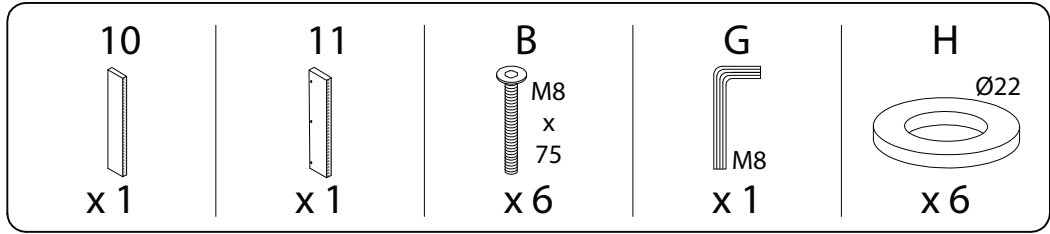

8

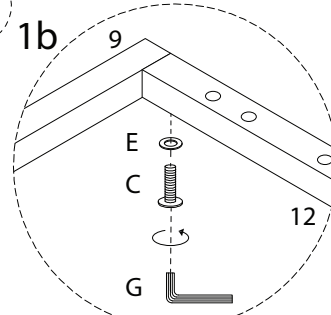
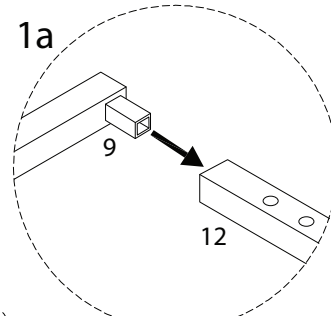
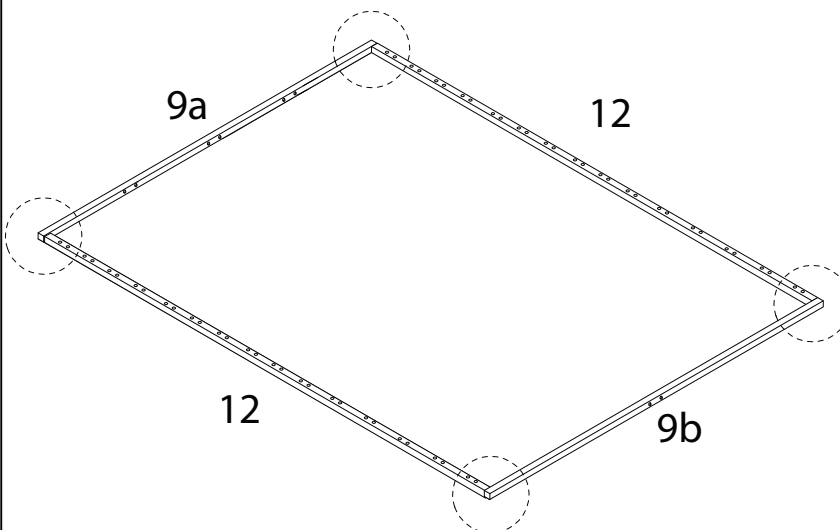
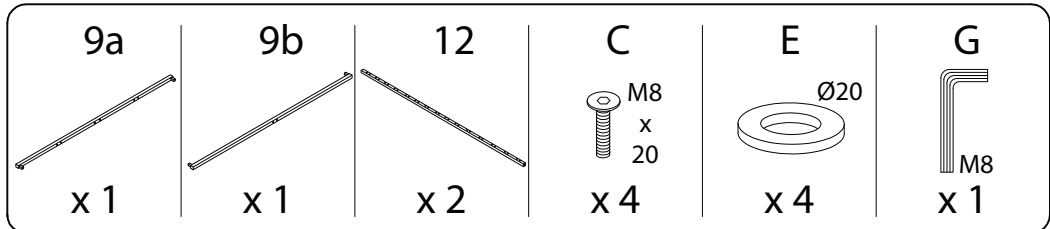

9

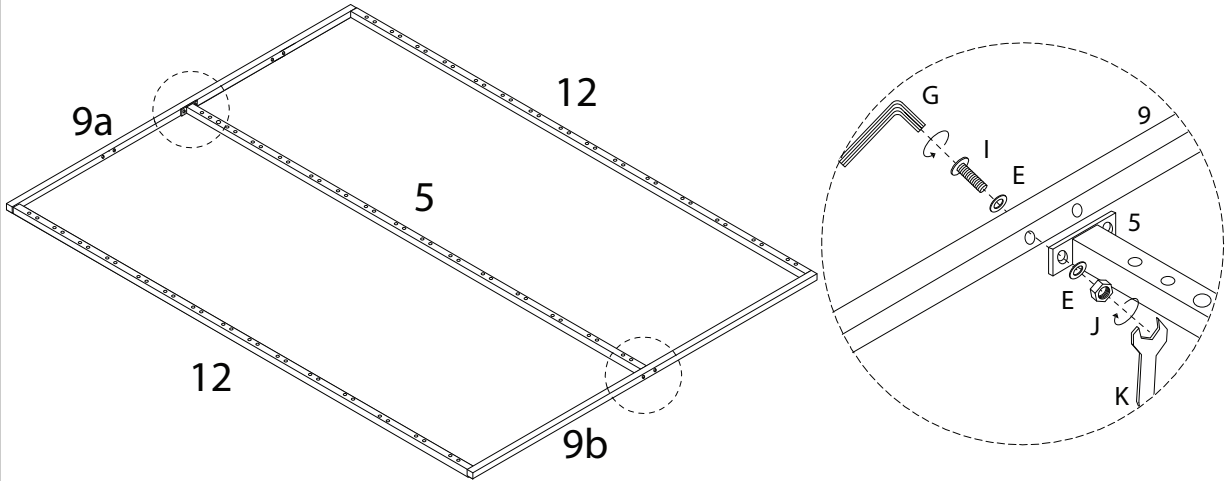
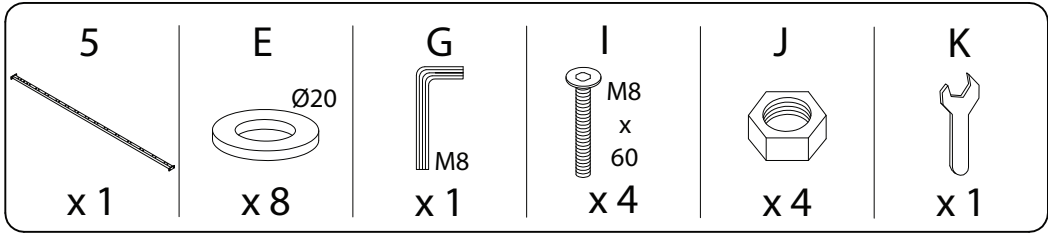

10

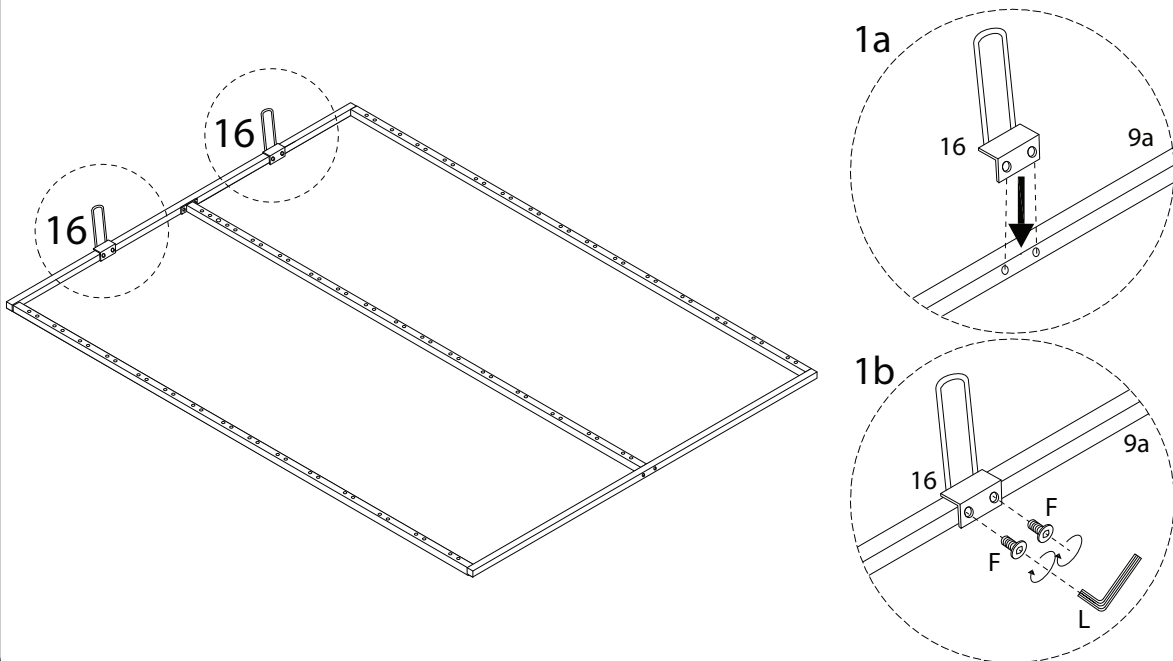
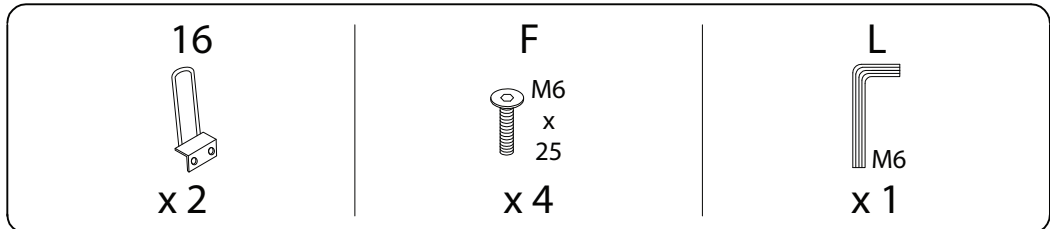

11

6



x 1

A



x 1

E

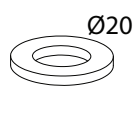

x 1

G



x 1

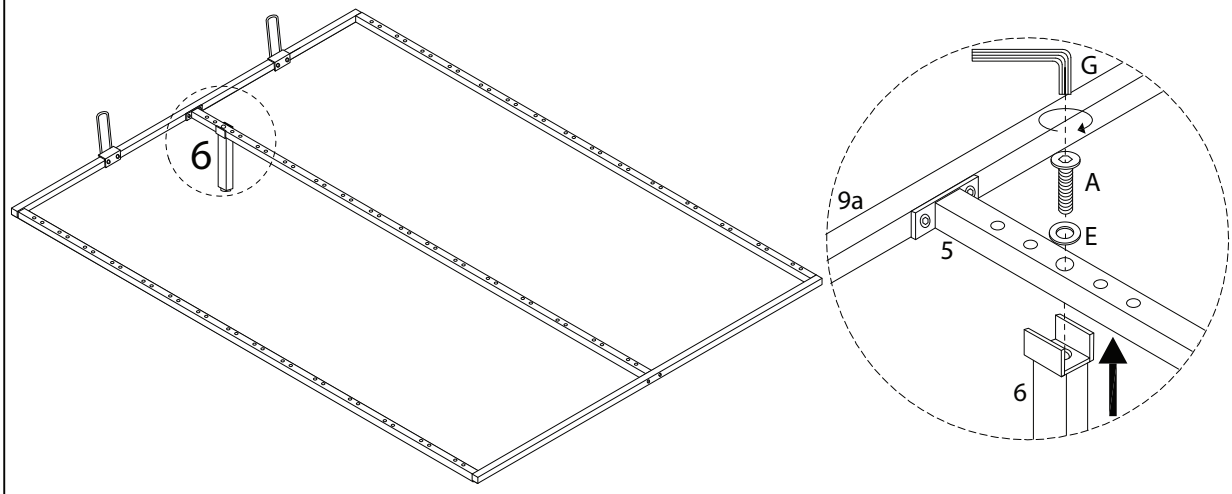

12

13

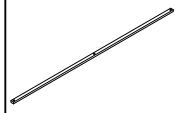

x 1

E

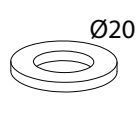

x 18

G

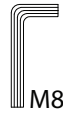

x 1

I

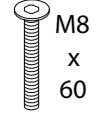

x 9

J

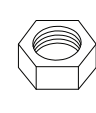

x 9

K



x 1

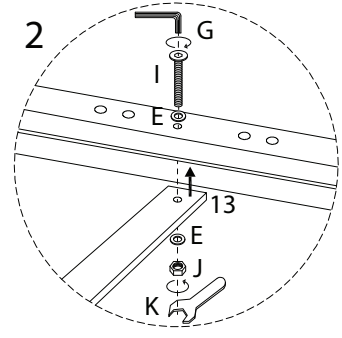
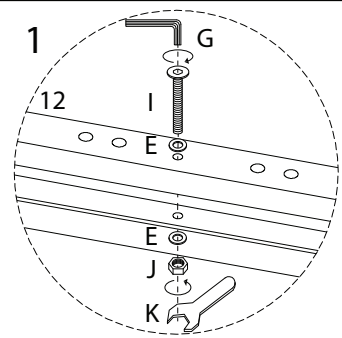
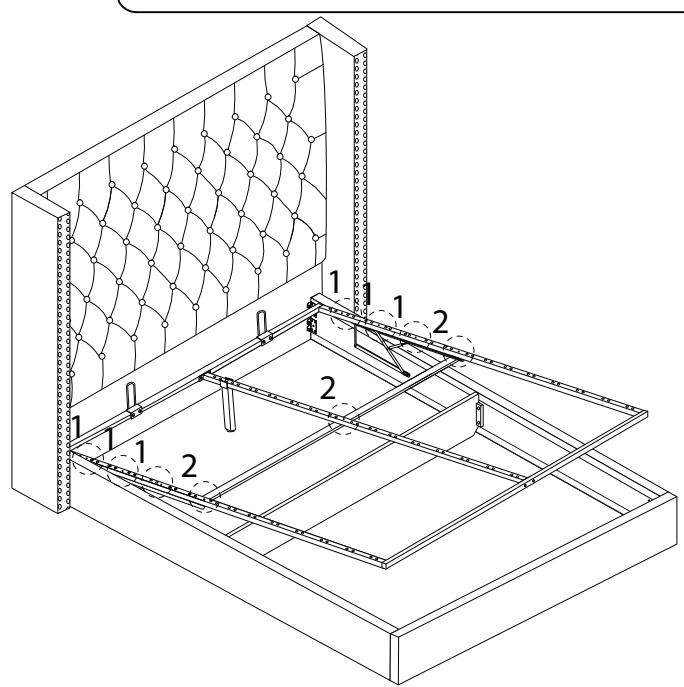

13

J



x 2

K



x 1

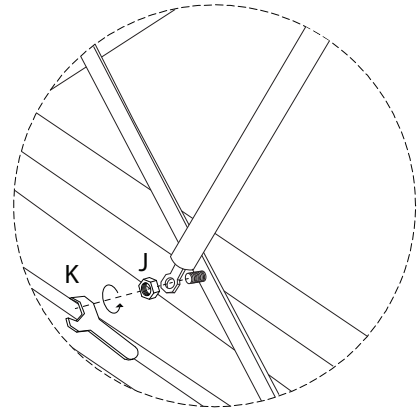
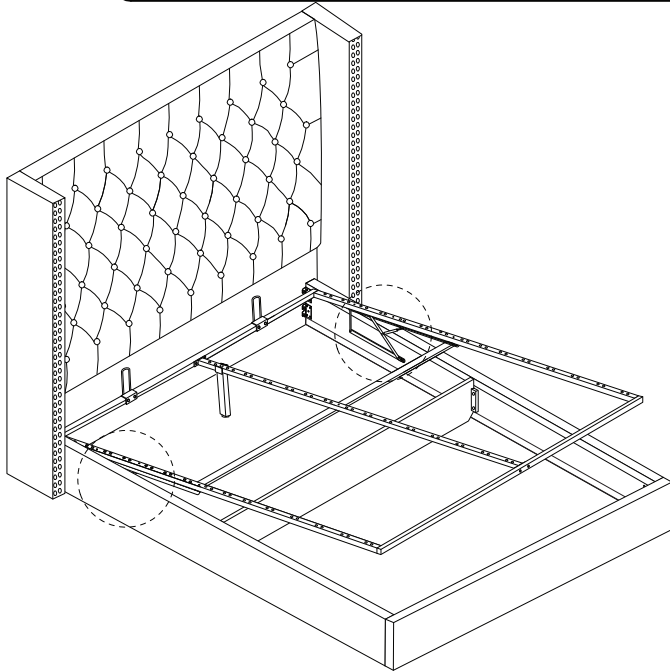

14

4

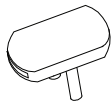

x 1

7

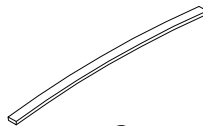

x 2

8



x 2

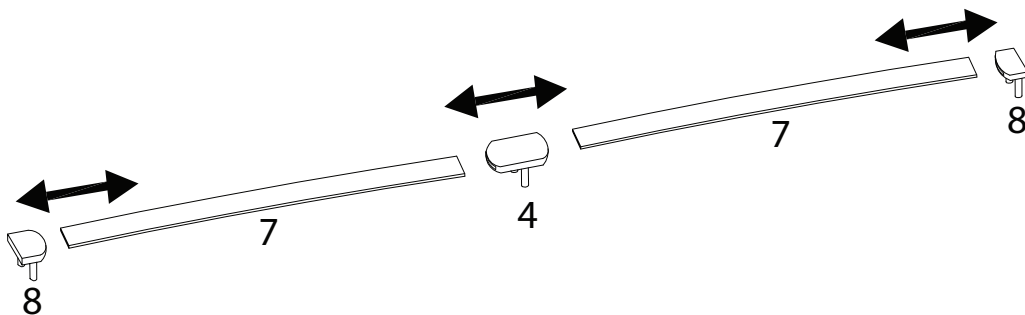

15

