

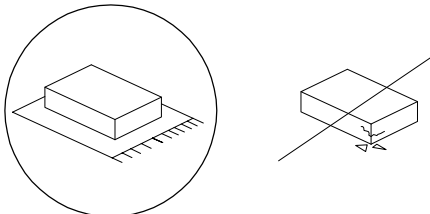

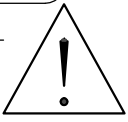

		<b>30'</b>
		
		<b>1</b>

1/4

<b>1</b>	<b>2</b>	<b>3</b>	<b>4</b>
			
<b>x 1</b>	<b>x 1</b>	<b>x 1</b>	<b>x 3</b>

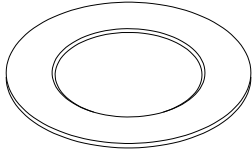
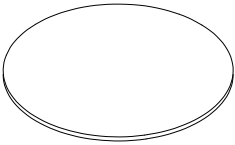

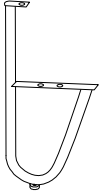
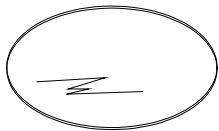
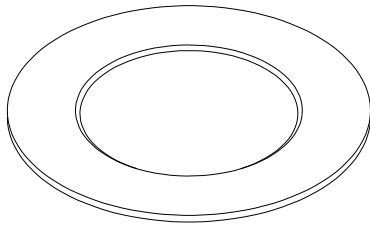
**3**





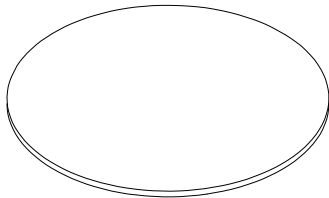

**1**

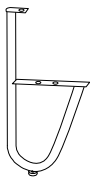

**2**

**4 x 3**

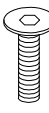
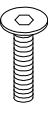

<b>A</b>	<b>B</b>	<b>C</b>	<b>D</b>	<b>E</b>
	 M8 x 16	 M6 x 16	 Ø18	 Ø16
<b>x 1</b>	<b>x 3</b>	<b>x 6</b>	<b>x 3</b>	<b>x 6</b>

1

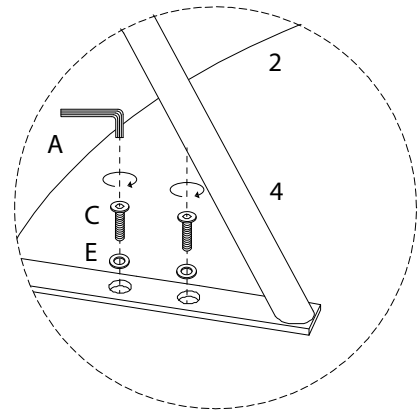
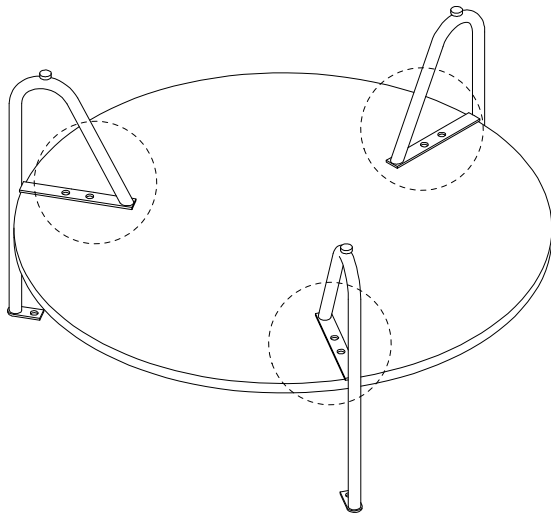
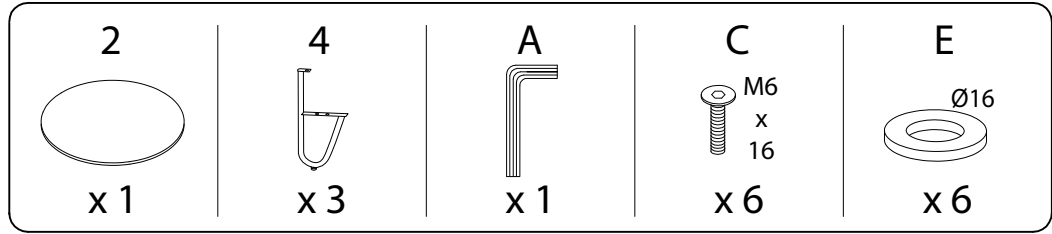

2

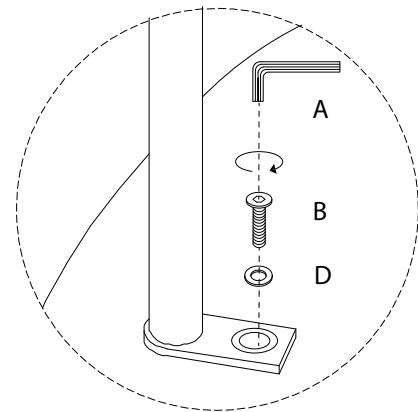
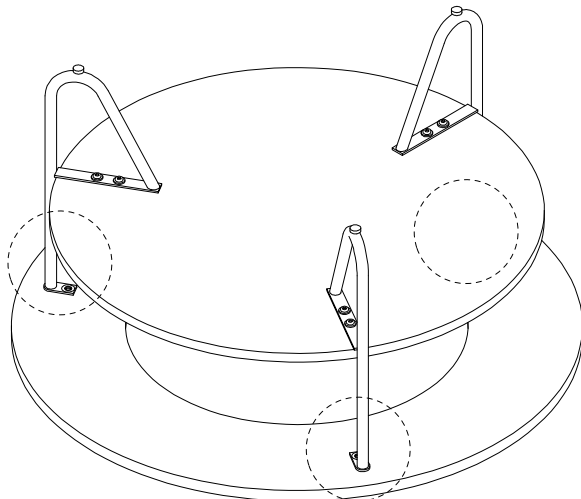
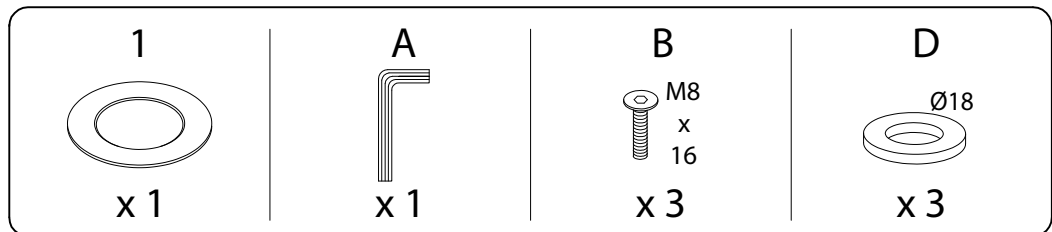

3

