



1/5



| | | | | |
|---|---|---|--|---|
| A | B | C | D | E |
|  |  |  |  |  |
| x 1 | x 1 | x 5 | x 5 | x 5 |

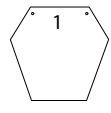
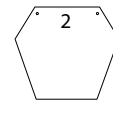
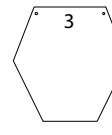
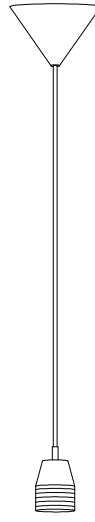

A

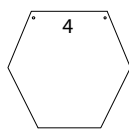
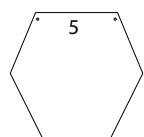
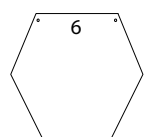
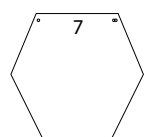
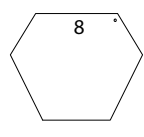
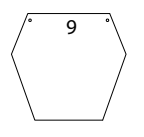
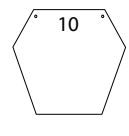
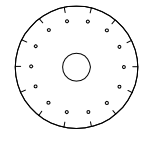
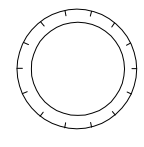

B

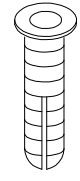
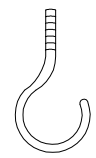
| | | | | | |
|---|---|---|---|---|---|
| F | G | H | I | J | K |
|  |  |  |  |  |  |
| x 5 | x 5 | x 5 | x 5 | x 5 | x 5 |
| L | M | N | O | P | Q |
|  |  |  |  |  |  |
| x 5 | x 1 | x 1 | x 10 | x 1 | x 1 |



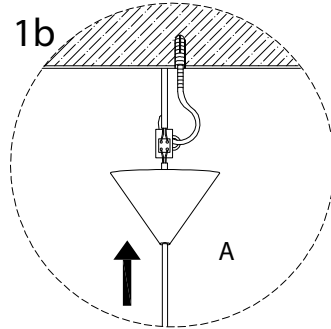
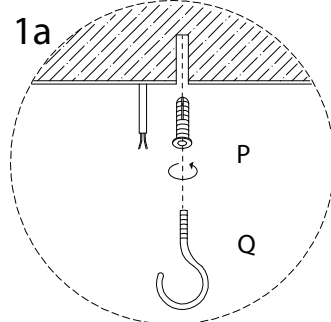
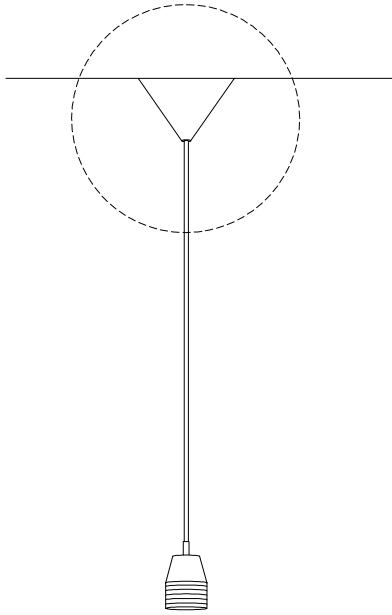
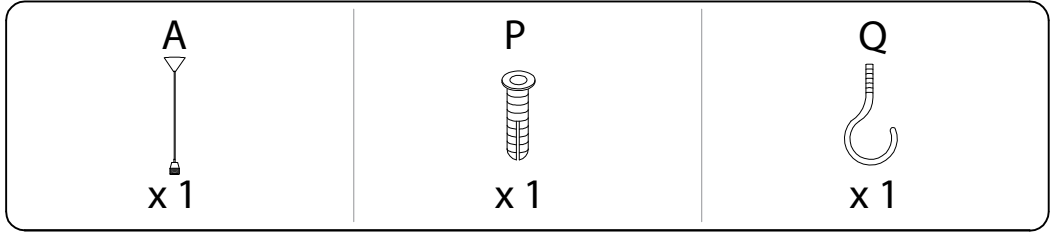

1

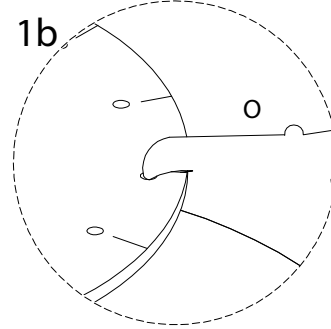
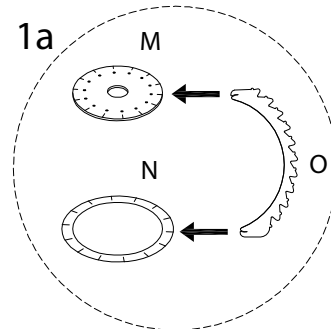
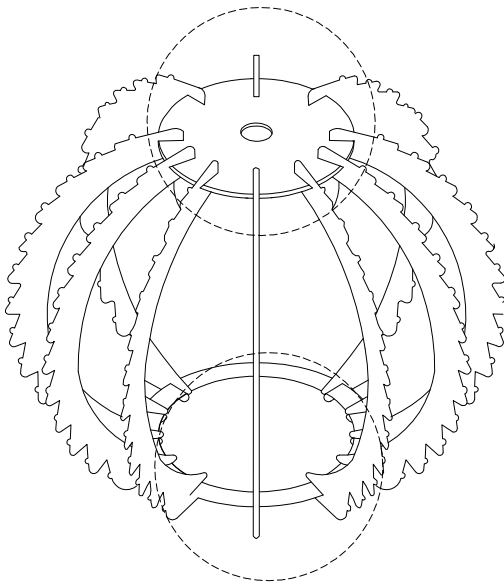
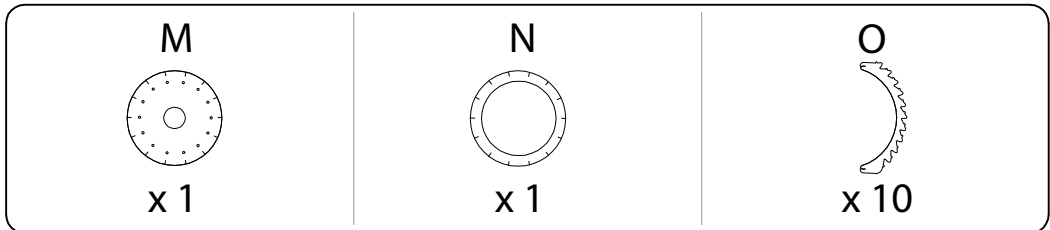

2

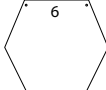
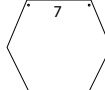
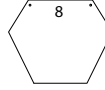
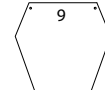
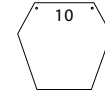

3

| | | | | |
|--|--|--|--|--|
| <p>C</p>  <p>x5</p> | <p>D</p>  <p>x5</p> | <p>E</p>  <p>x5</p> | <p>F</p>  <p>x5</p> | <p>G</p>  <p>x5</p> |
| <p>H</p>  <p>x5</p> | <p>I</p>  <p>x5</p> | <p>J</p>  <p>x5</p> | <p>K</p>  <p>x5</p> | <p>L</p>  <p>x5</p> |

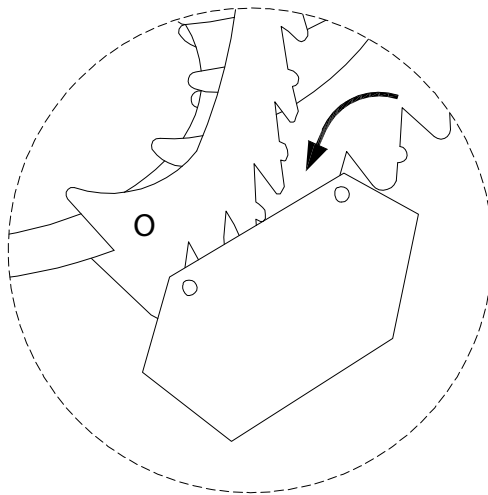
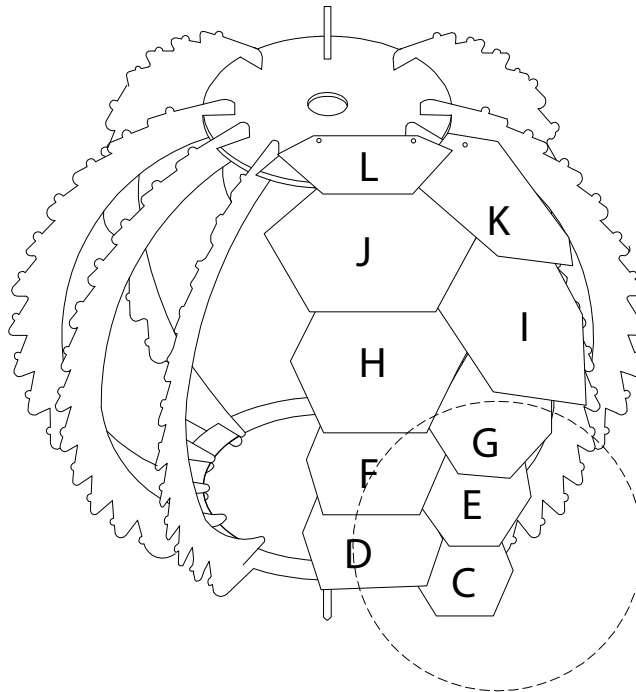

4

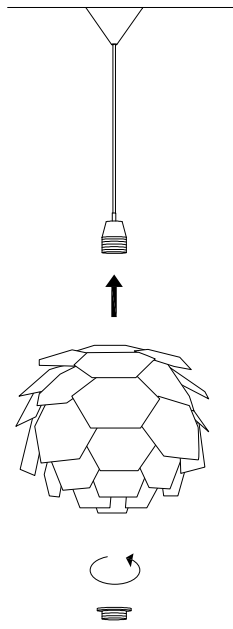
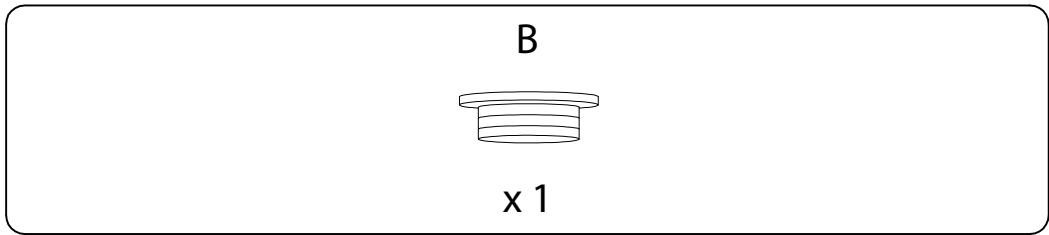

5

