

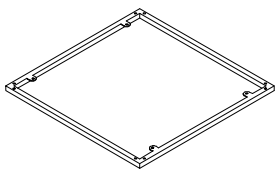

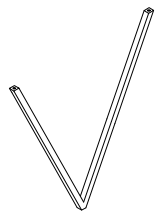

1/4

<p>A</p>  <p>x 1</p>	<p>B</p>  <p>x 4</p>	<p>C</p>  <p>M6 x 25</p> <p>x 8</p>	<p>D</p>  <p>x 1</p>
---	---	--	---

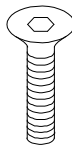
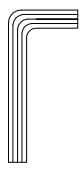
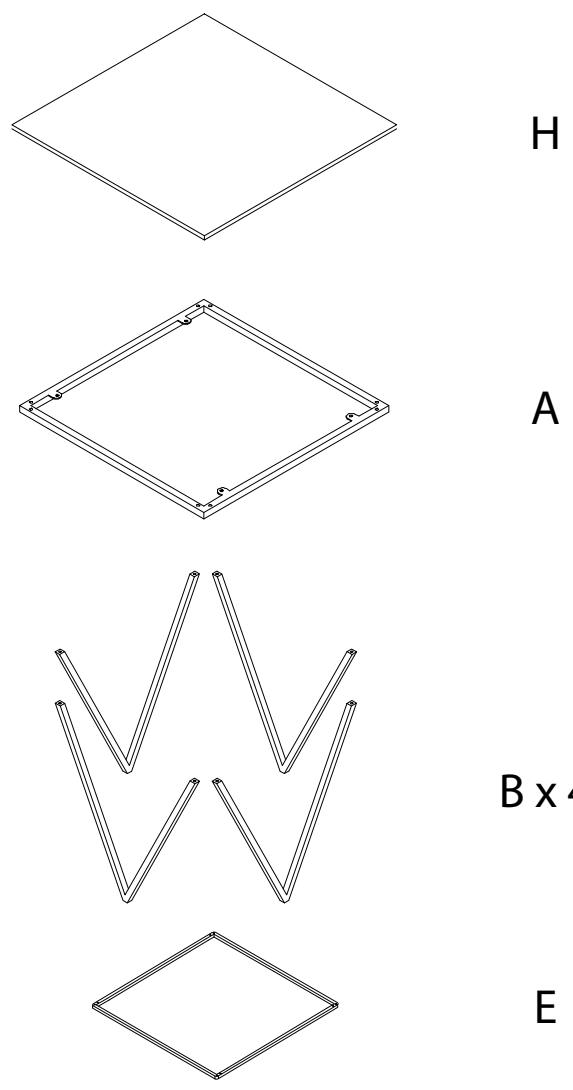
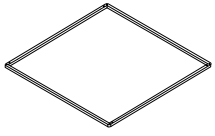
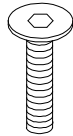

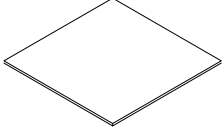
<p>E</p>  <p>x 1</p>	<p>F</p>  <p>M6 x 25</p> <p>x 4</p>	<p>G</p>  <p>x 4</p>	<p>H</p>  <p>x 1</p>	<p>I</p>  <p>M3.5 x 16</p> <p>x 4</p>
---	--	---	--	--

1

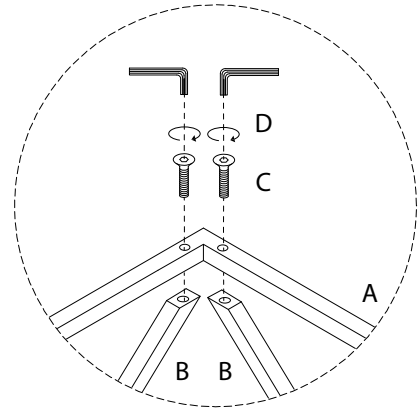
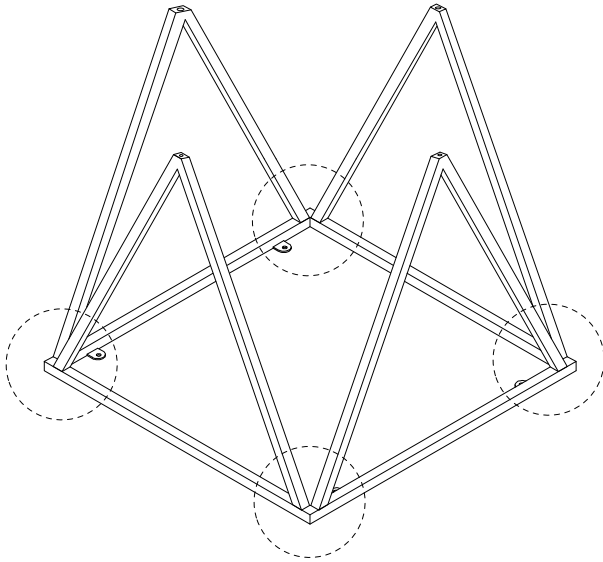
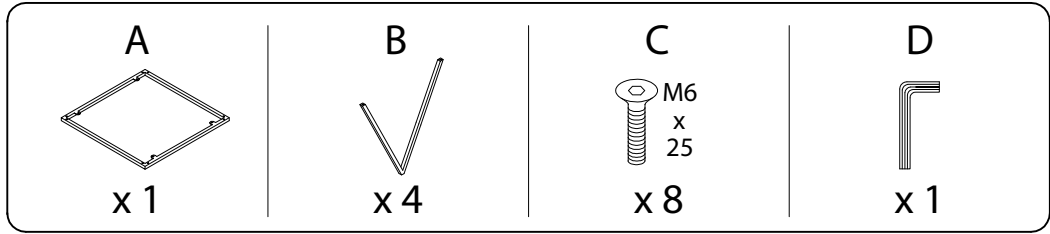

2

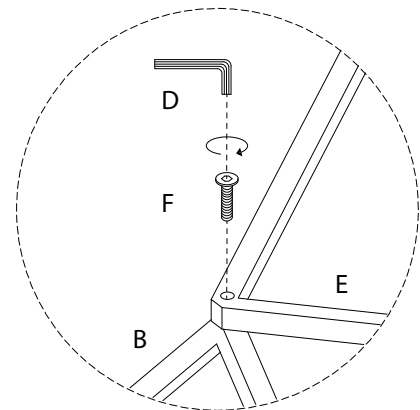
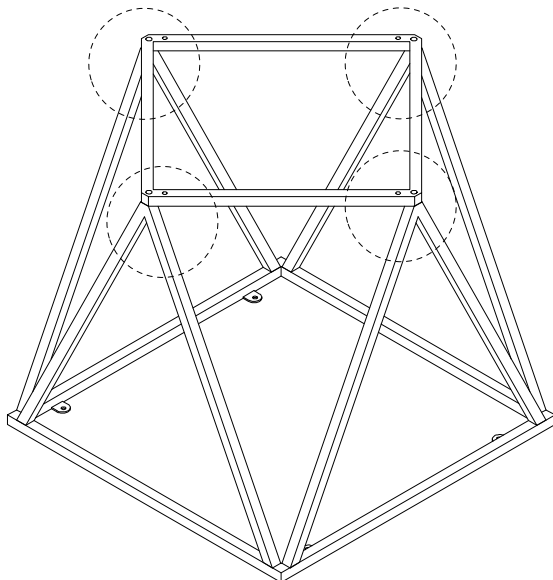
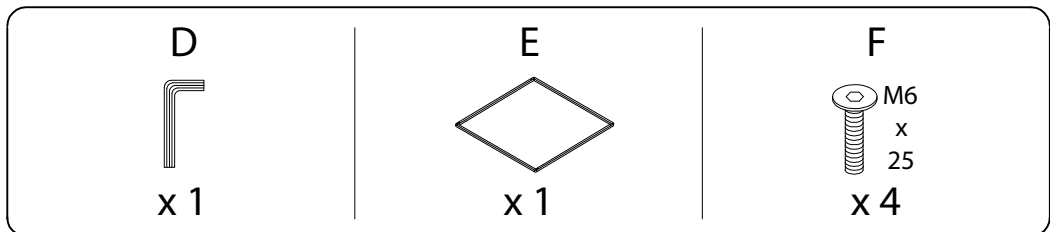

3

G

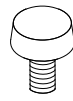

x 4

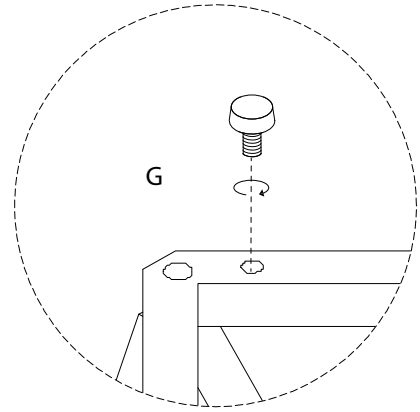
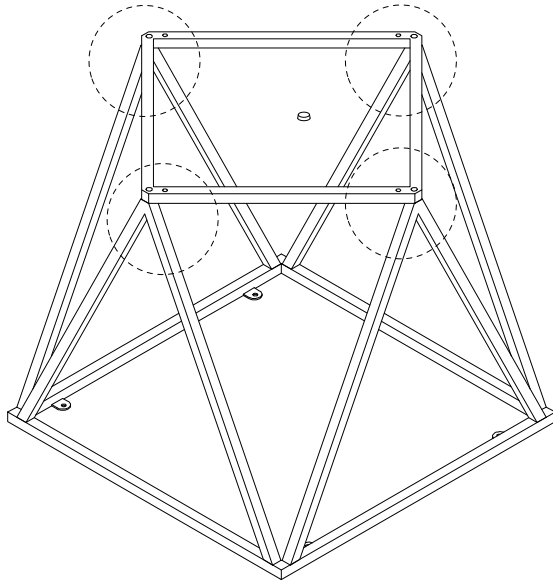

4

H

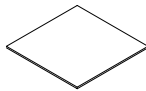

x 1

I

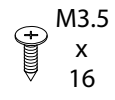

M3.5
x
16

x 4

