

		<p>20'</p>
		
		<p>1</p>

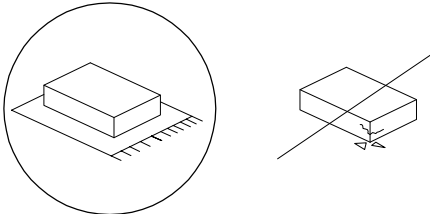

F x 4

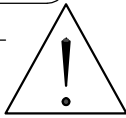
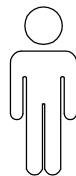
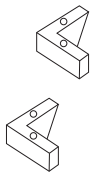
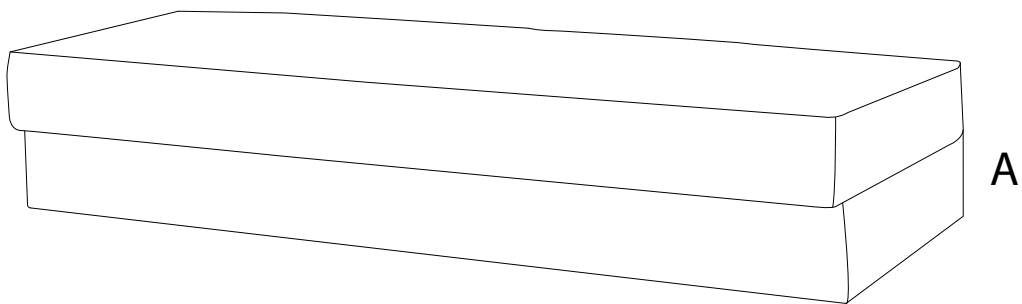
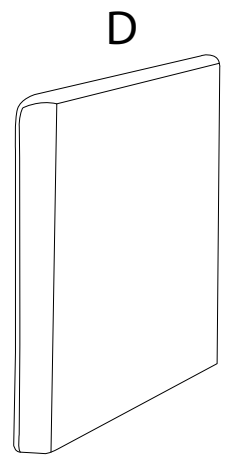
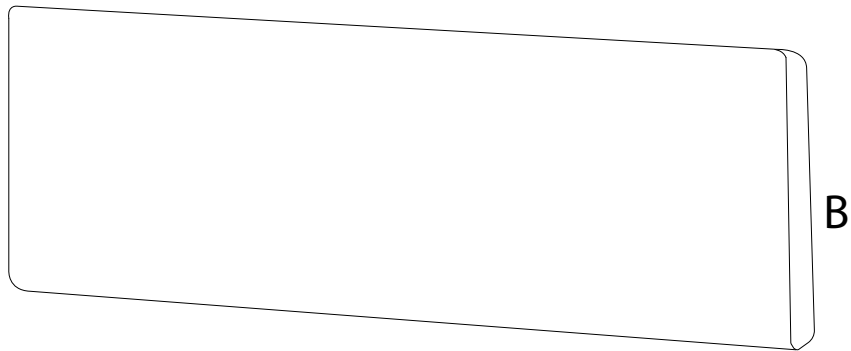
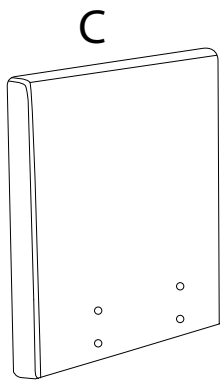
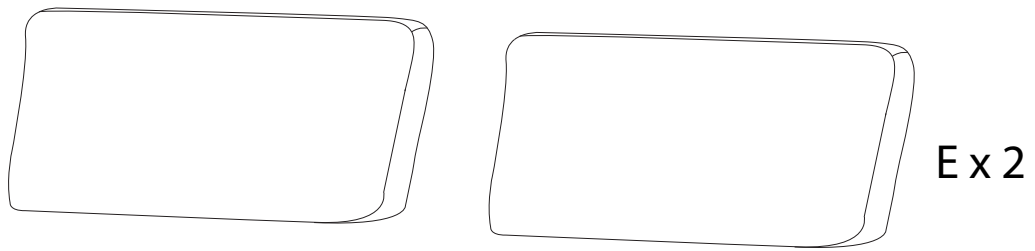
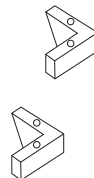
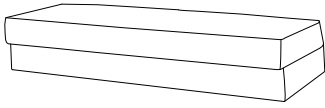

A



x 1

B

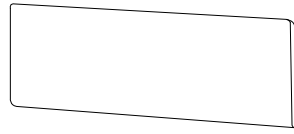

x 1

C

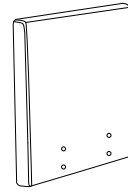

x 1

D

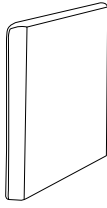

x 1

E

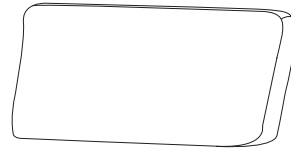

x 2

F

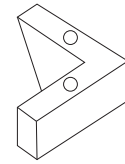

x 4

G

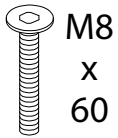

x 2

H

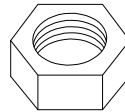

x 10

I

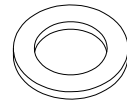

x 10

J

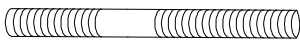

x 8

K

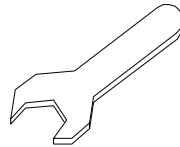

x 1

L

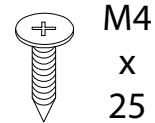

x 8

M

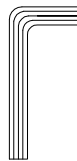

x 1

1

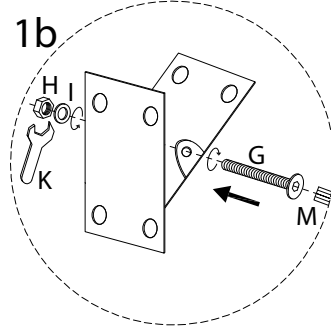
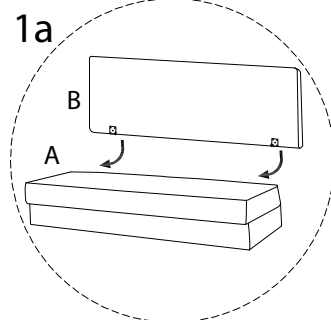
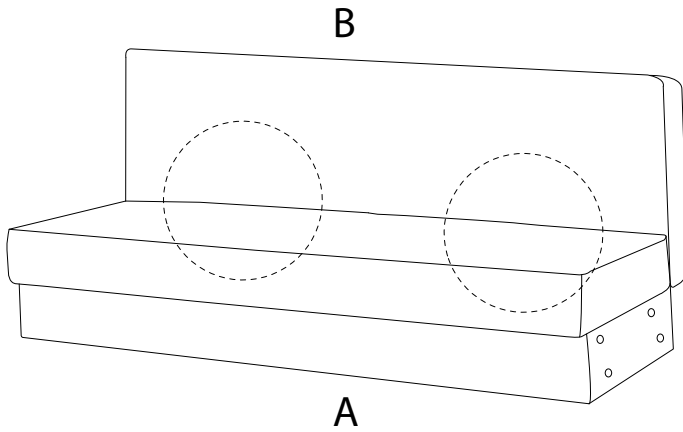
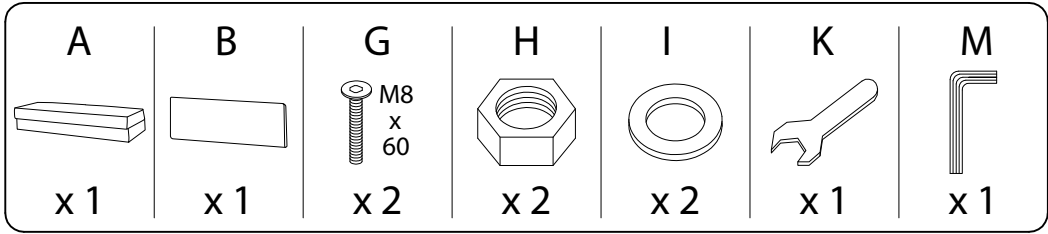

2

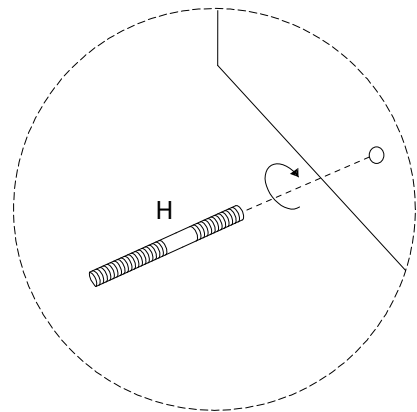
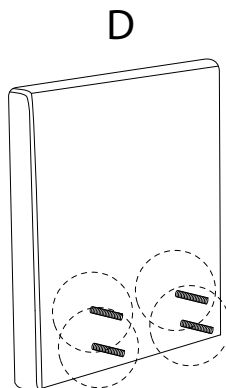
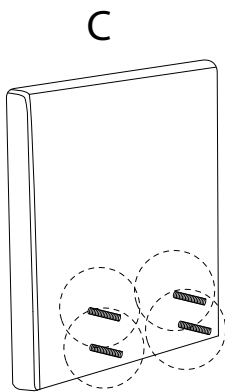
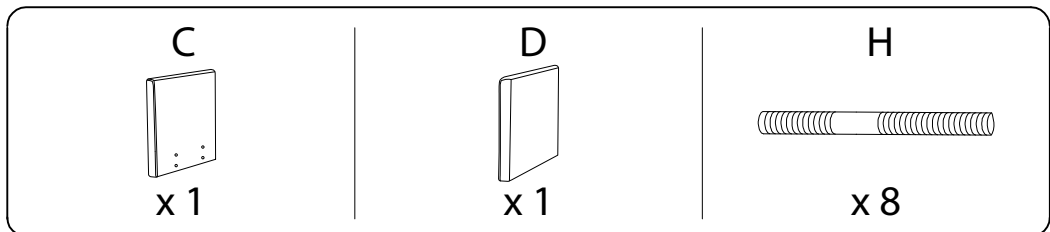

3

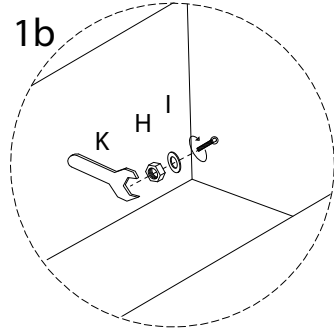
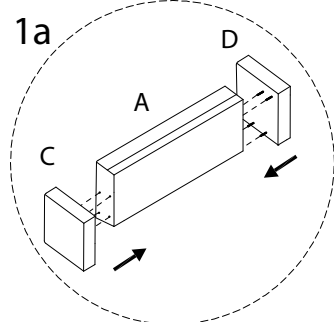
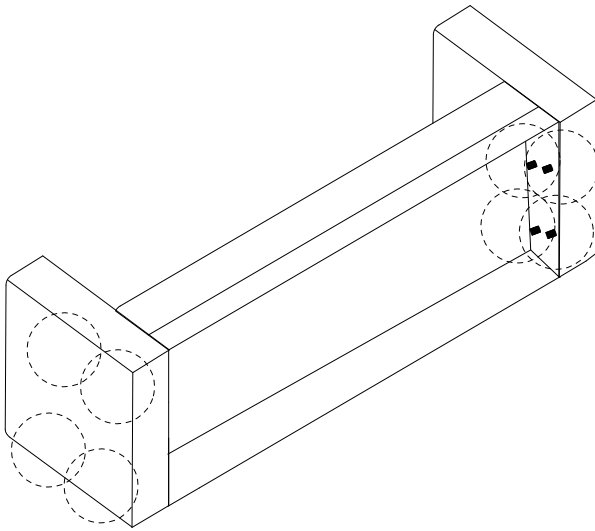
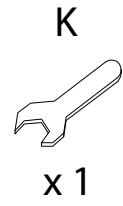
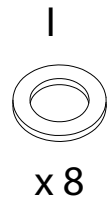
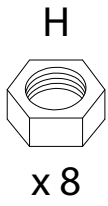

4

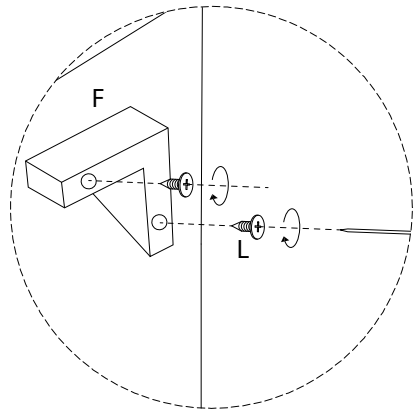
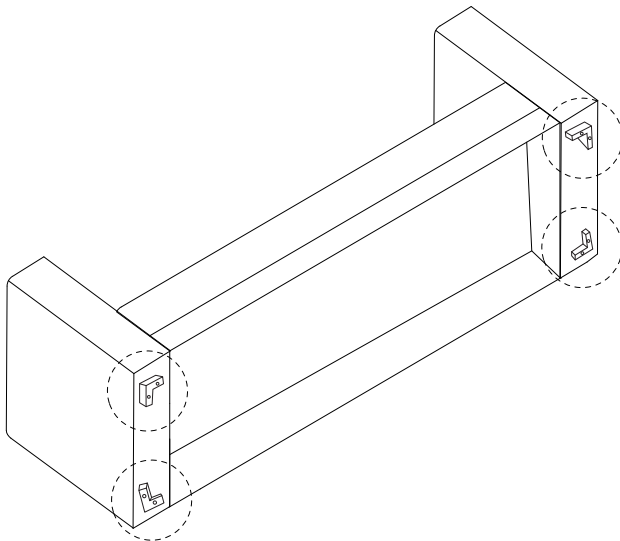
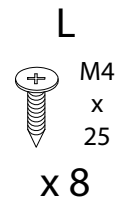
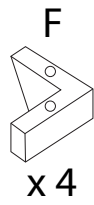

5

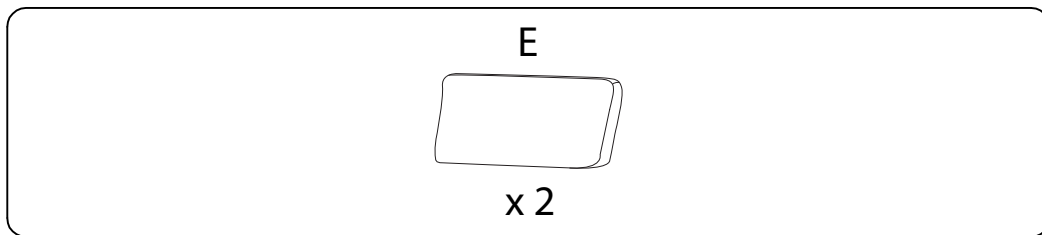

E x 2

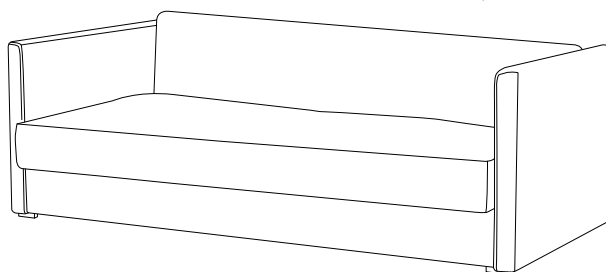
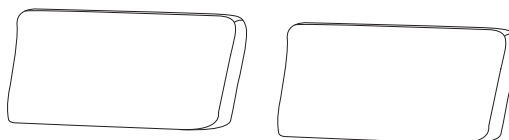

!

