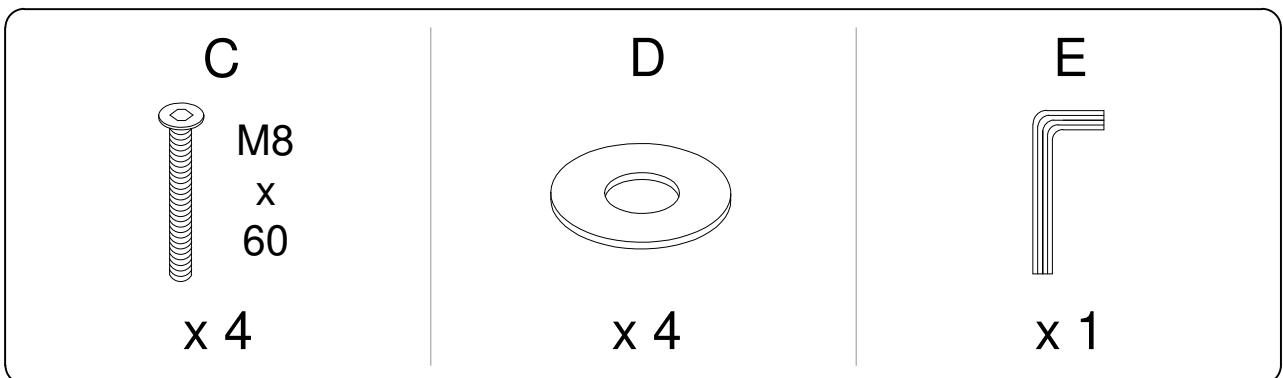
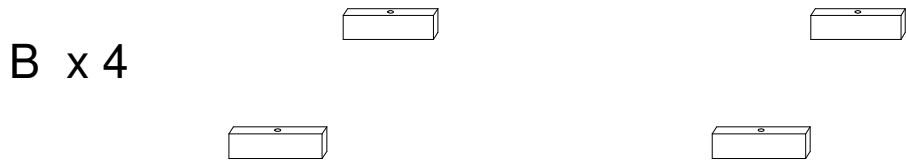
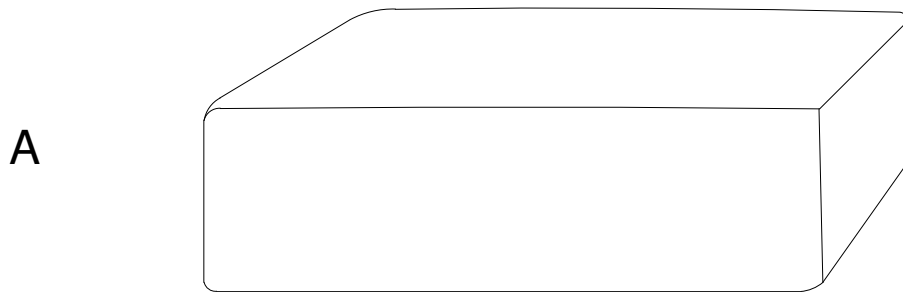
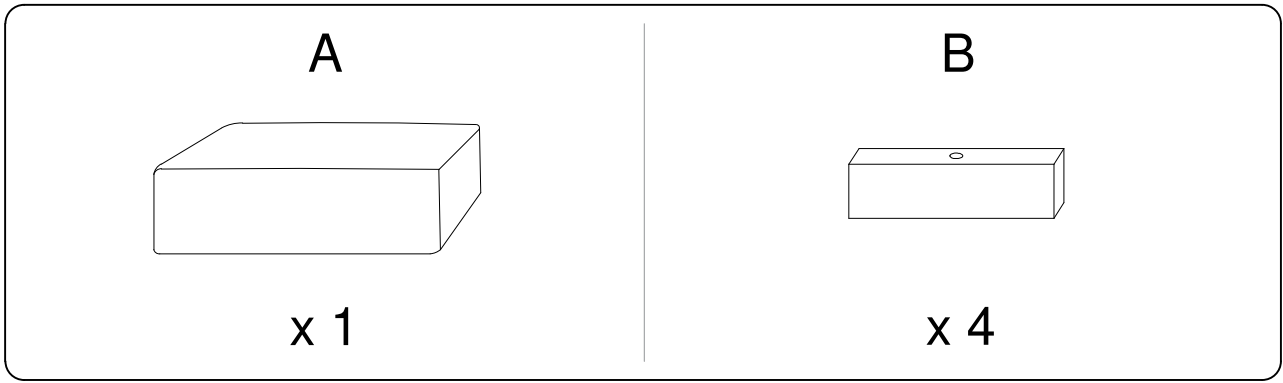
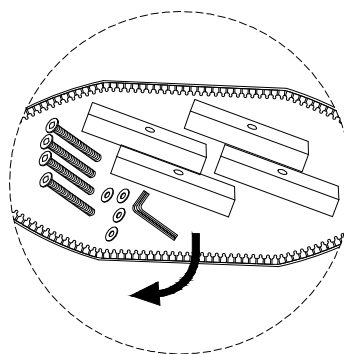
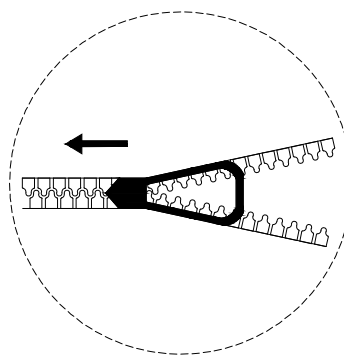
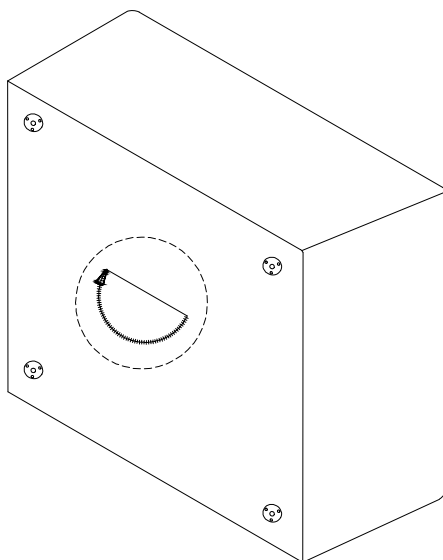

Diagram illustrating assembly instructions and safety warnings:

- Warning 1:** A warning triangle with an exclamation mark is connected by a vertical line to a box containing:
 - A circular icon showing an L-shaped metal bracket.
 - An icon of a power drill with a diagonal slash through it, indicating that a power drill should not be used.
- Warning 2:** A second warning triangle with an exclamation mark is connected by a vertical line to a box containing:
 - A circular icon showing a rectangular block being placed on a textured surface.
 - An icon of a rectangular block with a diagonal slash through it, indicating that the block should not be placed on a soft or uneven surface.
- Time:** A clock icon with the text "10'" below it, indicating a 10-minute assembly time.
- Person:** An icon of a person with the text "1" below it, indicating that one person is required for assembly.



!



1

A

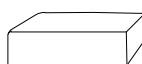

x 1

B

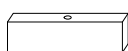

x 4

C

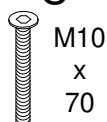

x 4

D



x 4

E



x 1

