

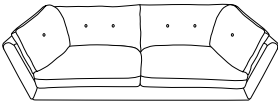

Assembly instructions for step 1/3:

- Tools:** A screwdriver is shown as the required tool. A power drill is shown with a diagonal line through it, indicating it is not to be used.
- Warning:** A warning triangle with an exclamation mark is positioned above the tool icons.
- Time:** A clock icon is shown, with the text "15'" below it, indicating a 15-minute assembly time.
- Personnel:** An icon of a person is shown, with the text "1" below it, indicating that one person is required for assembly.
- Diagram:** A diagram shows a rectangular block being placed on a surface with a textured pattern. A second diagram shows the block being pushed down, with a diagonal line through it, indicating that the block should not be pushed down.

1/3

A	B	C	D
			 M7 x 30
x 1	x 4	x 1	x 16

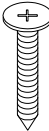
A

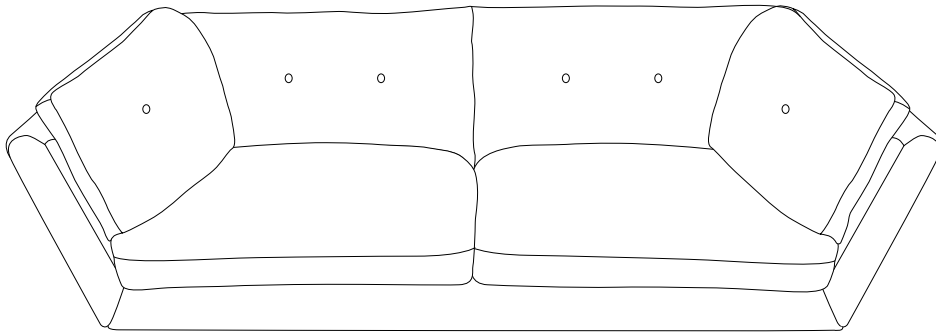



C

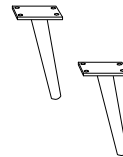
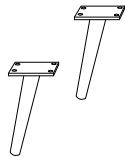

B x 4

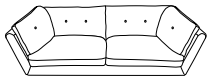

1

A  x 1	B  x 4	D  M7 x 30 x 16
--	--	--

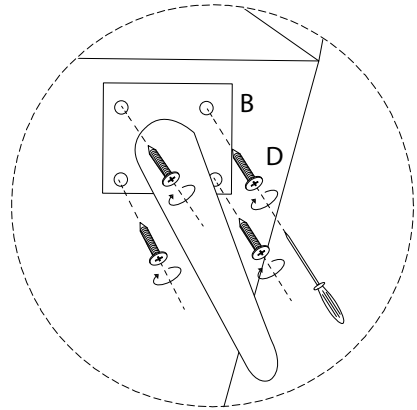
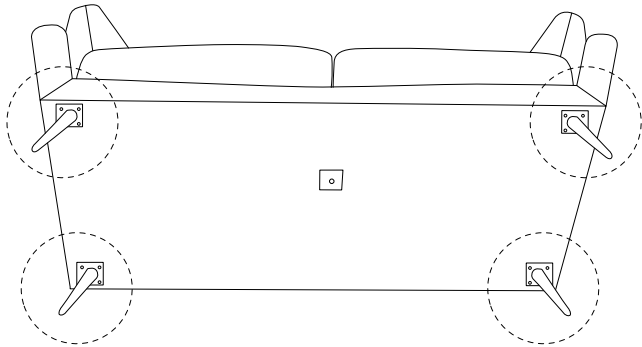

2

C  x 1
--

