

40'

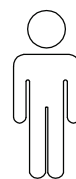

1



A x15

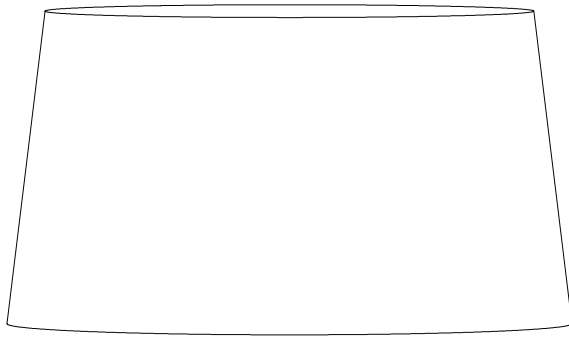

F

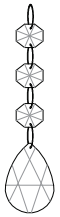

B x3

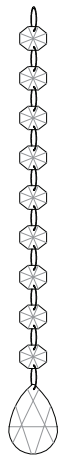

C x3



D x3



E x3

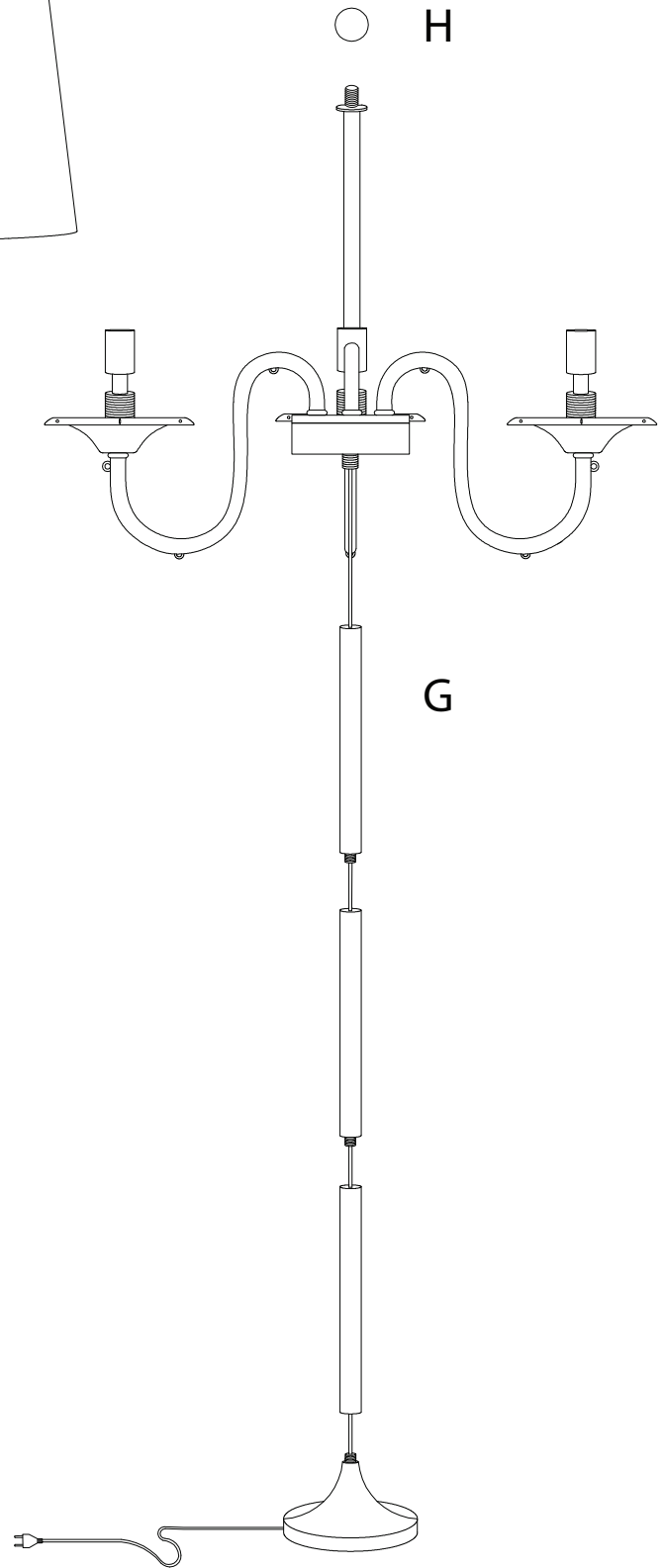

A



x 15

B

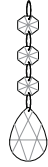

x 3

C



x 3

D

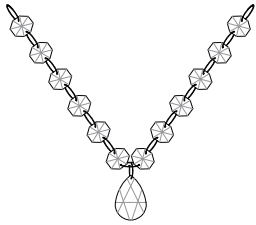

x 3

E



x 3

F

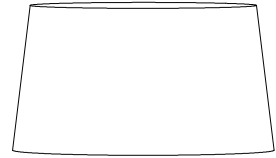

x 1

G

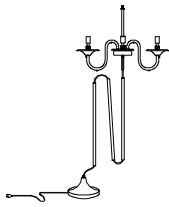

x 1

H

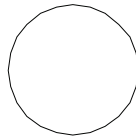

x 1

I

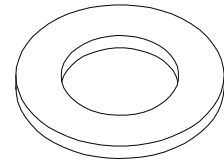

x 2

1

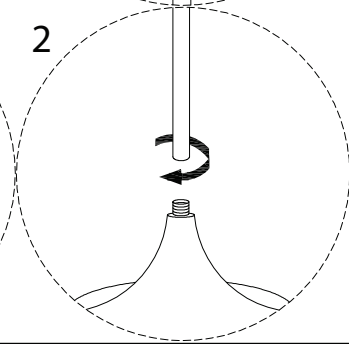
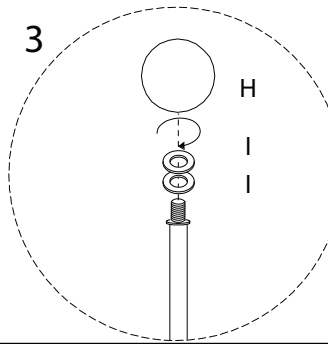
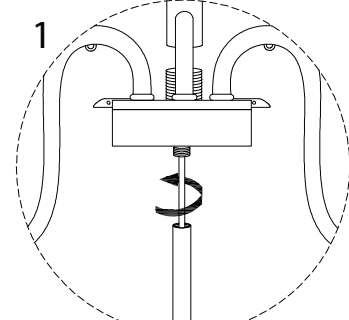
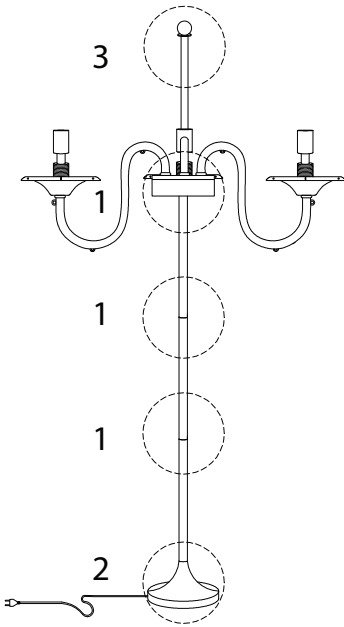
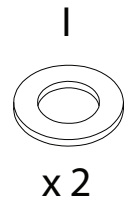
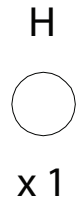
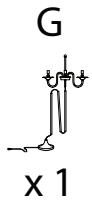

2

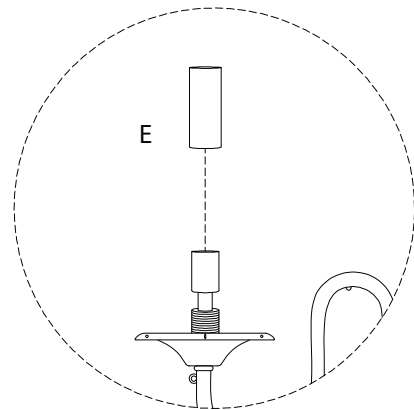
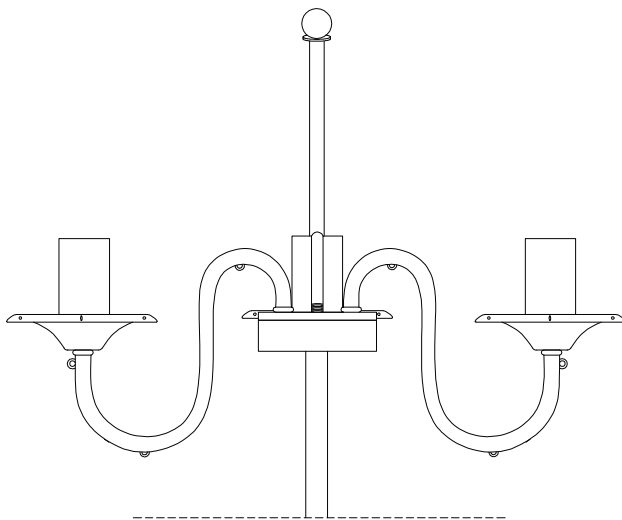

3

A  
x 15

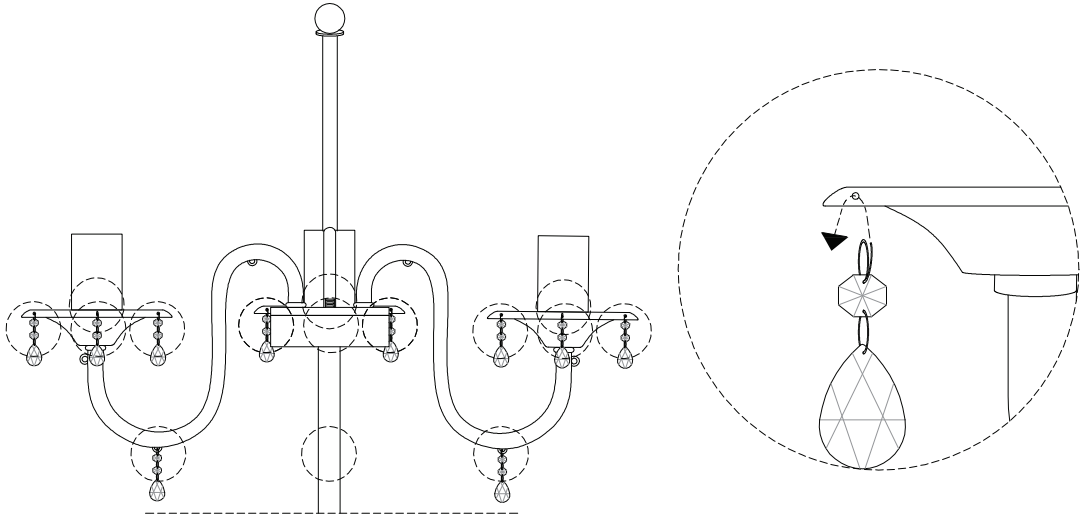

4

B  
x 3

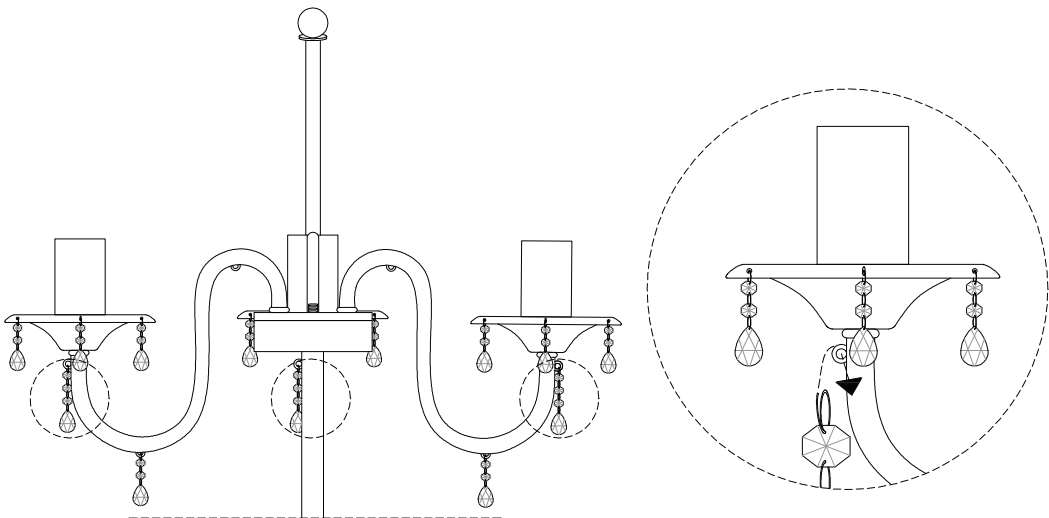

5

C



x 3

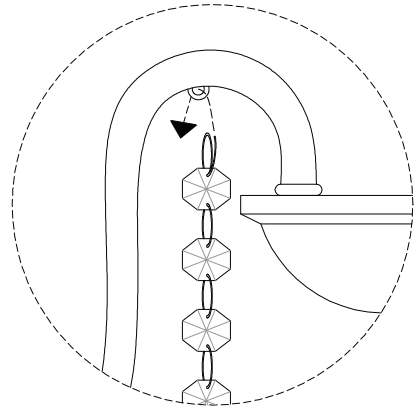
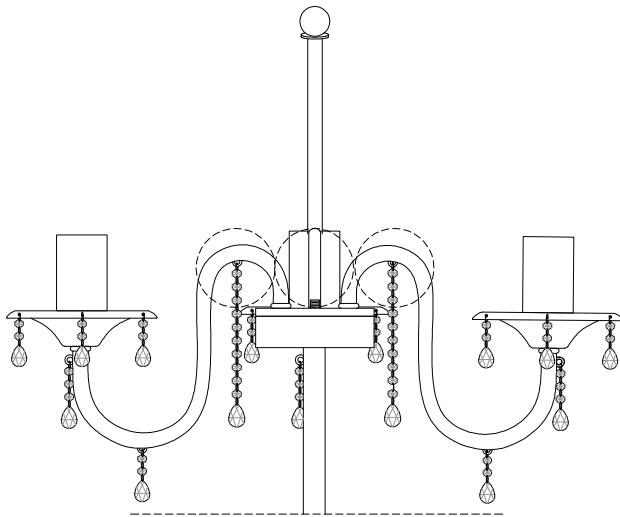

6

D



x 3

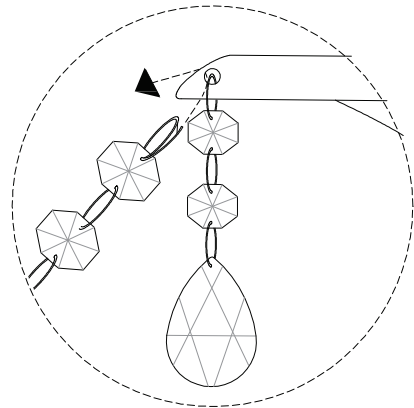
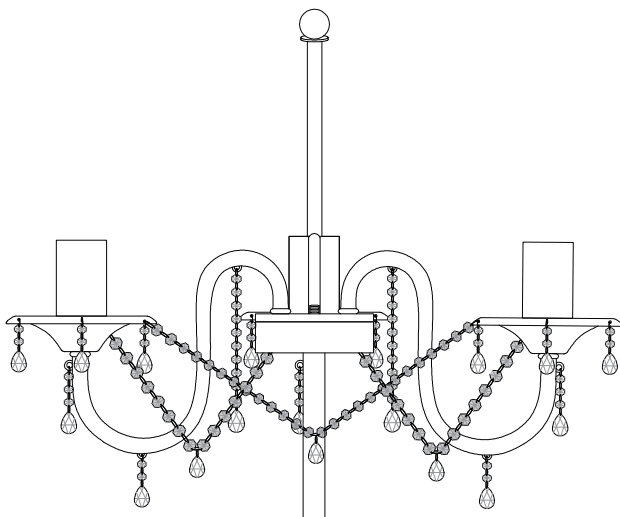

7

F



x 1

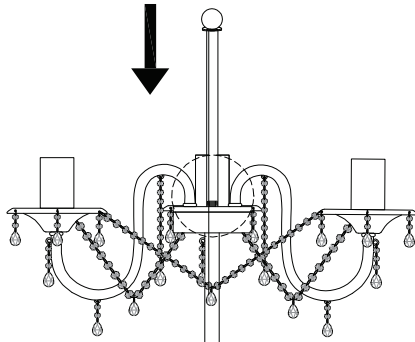
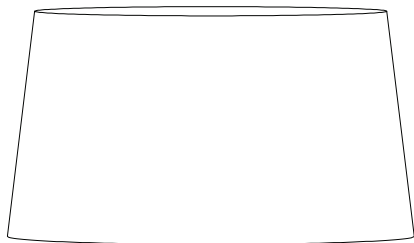

8

