

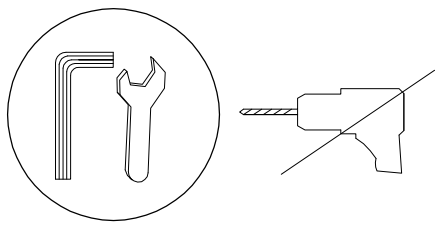

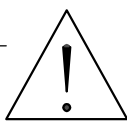
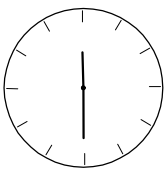
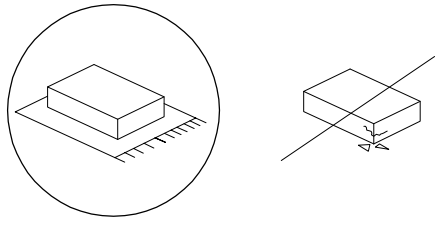

|   |   |   |
|---|---|---|
|  |  |  |
|  |  |  |

30'

2

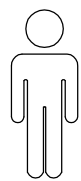
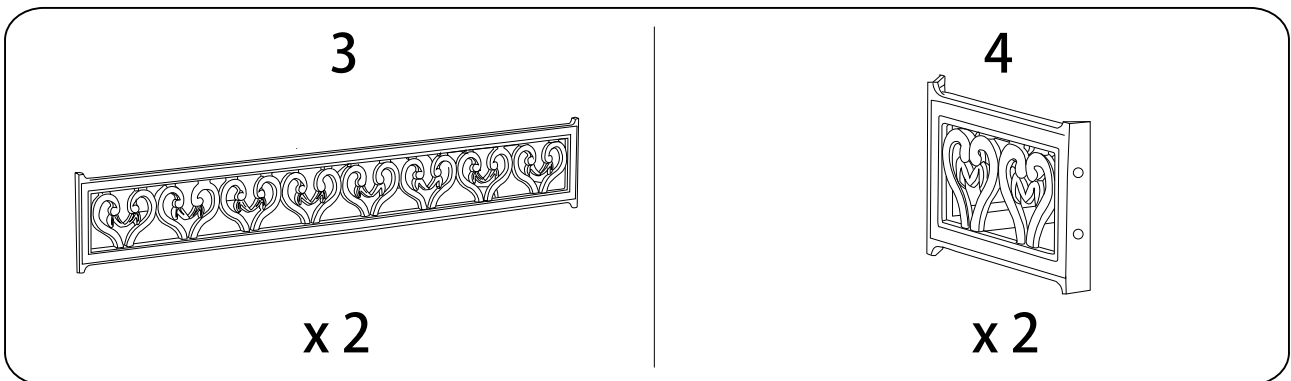
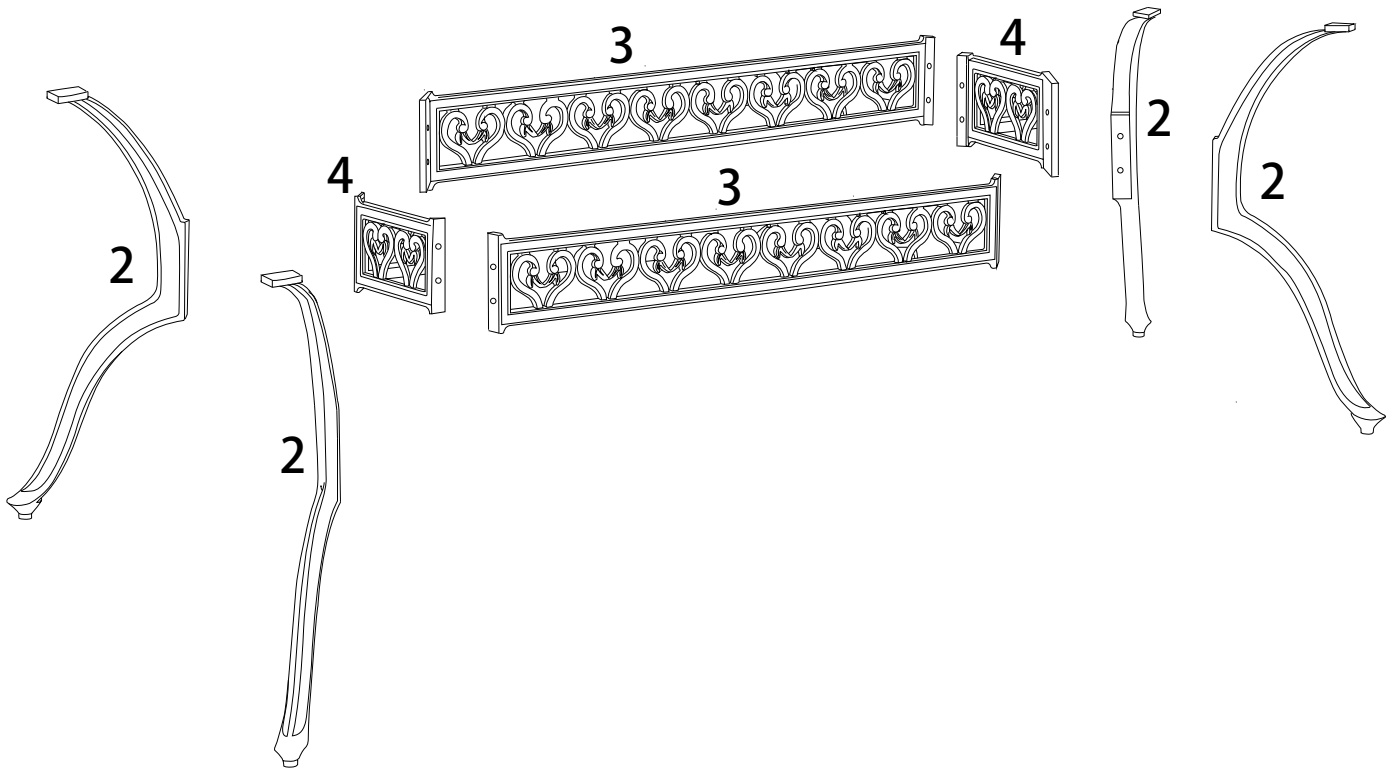
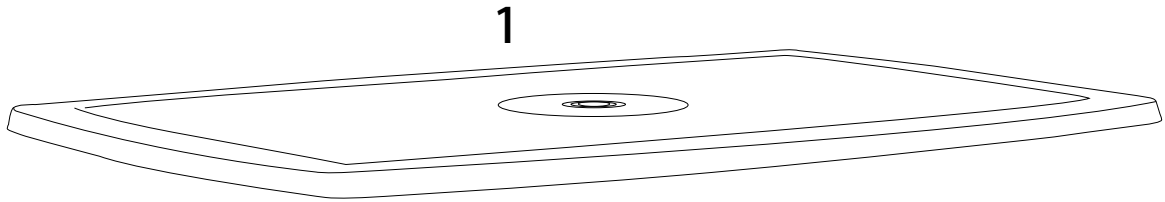
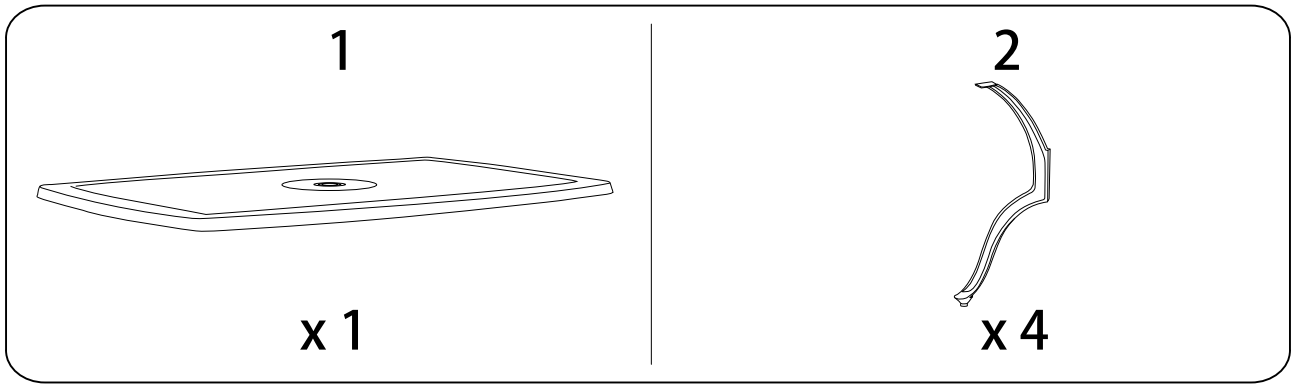

**A**

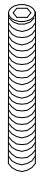

M8  
x  
35

x 12

**B**

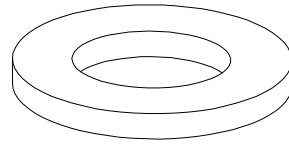

x 12

**C**

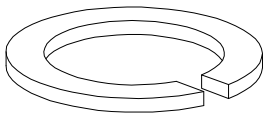

x 12

**D**

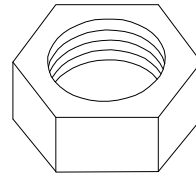

x 12

**E**

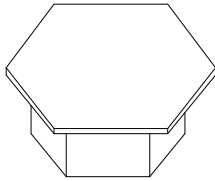

x 12

**F**

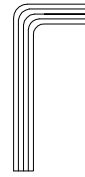

x 1

**G**

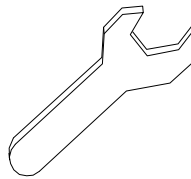

x 1

1 x4

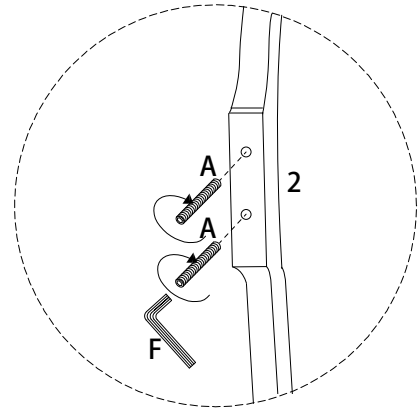
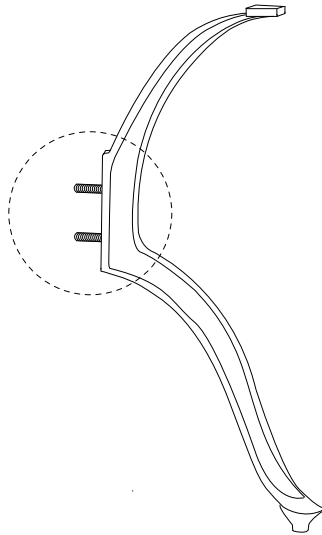
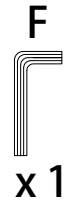
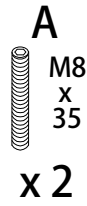

2 x2

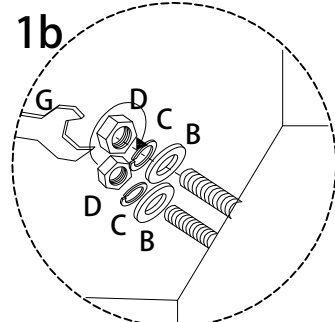
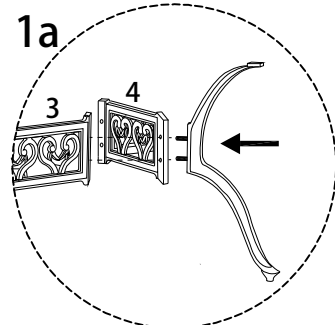
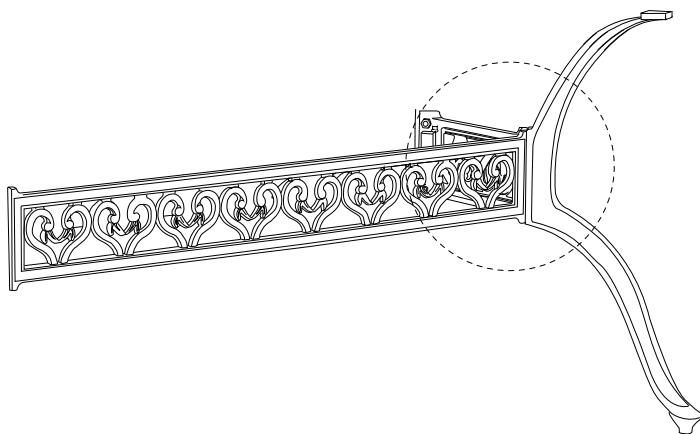
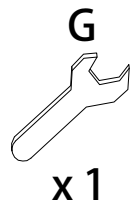
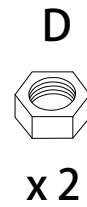
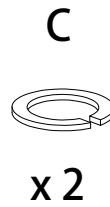
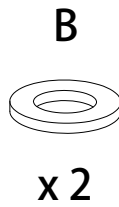
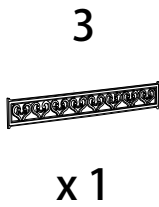

3

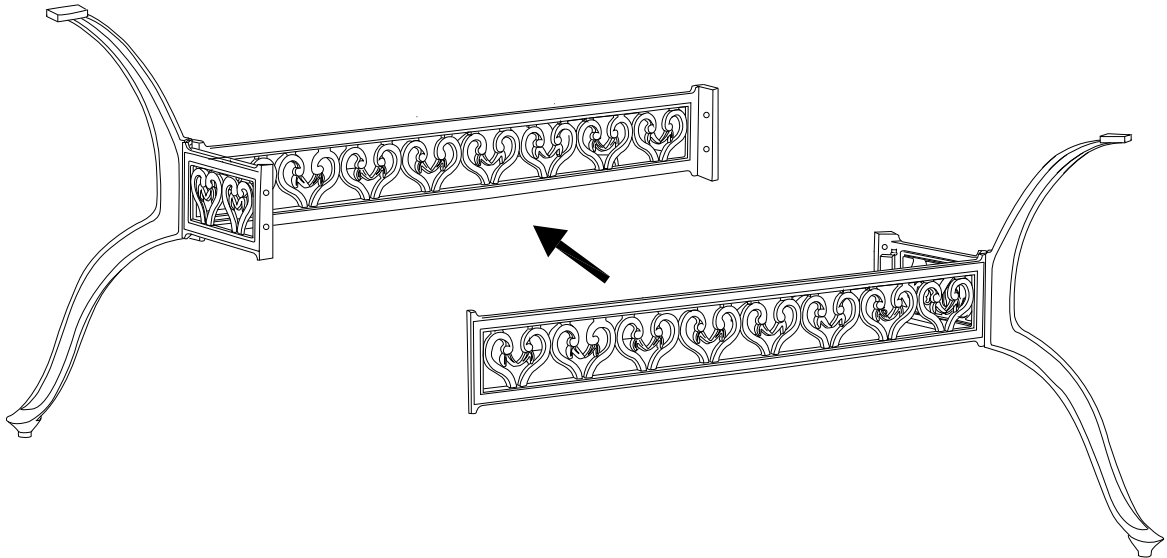

4

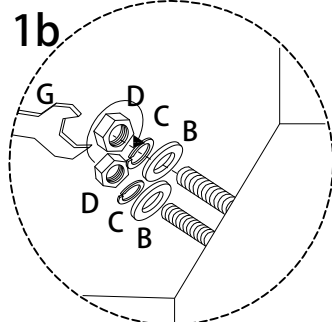
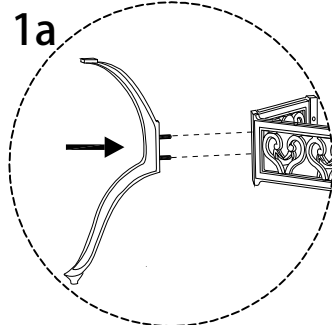
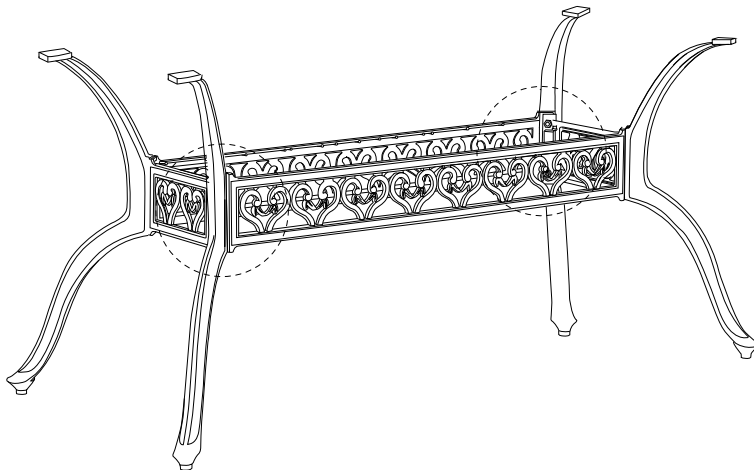
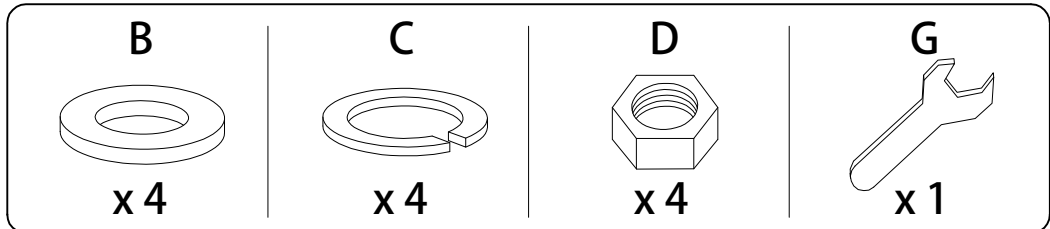

5

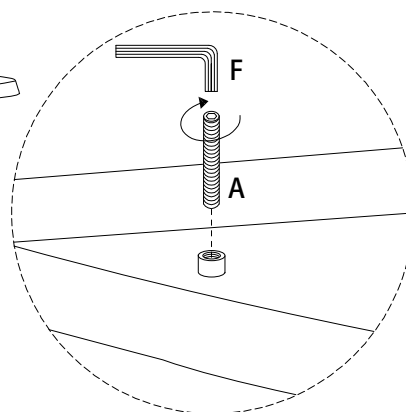
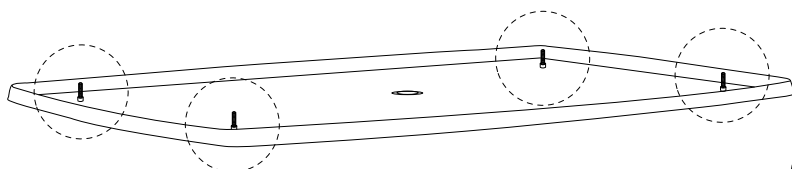
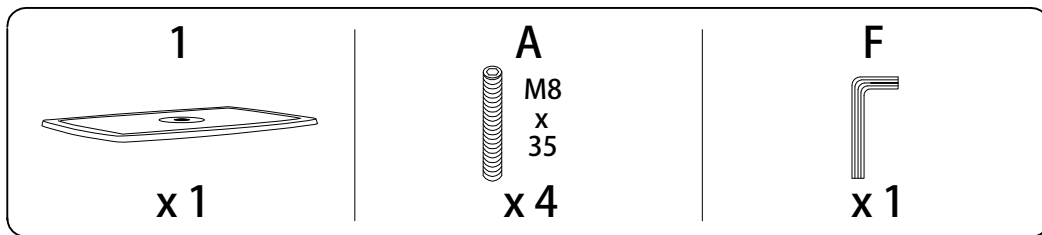

6

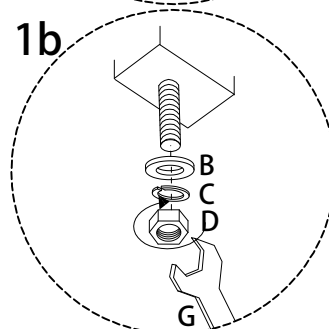
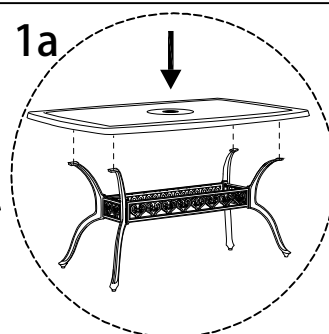
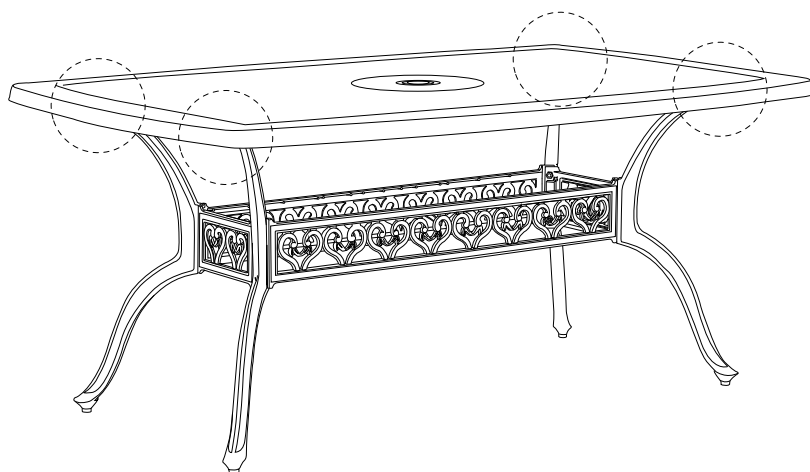
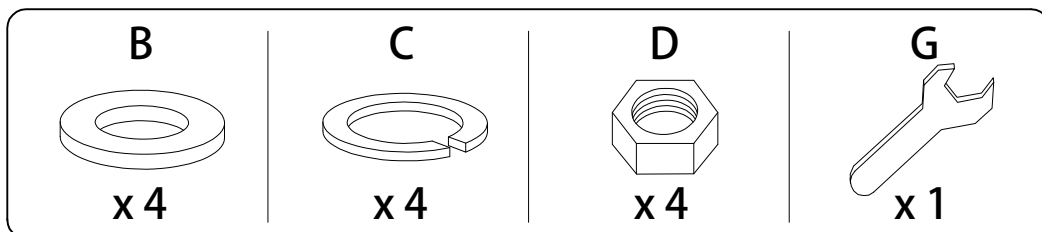

7

E

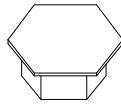

x 12

