

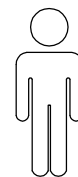

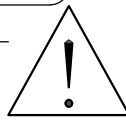

30'

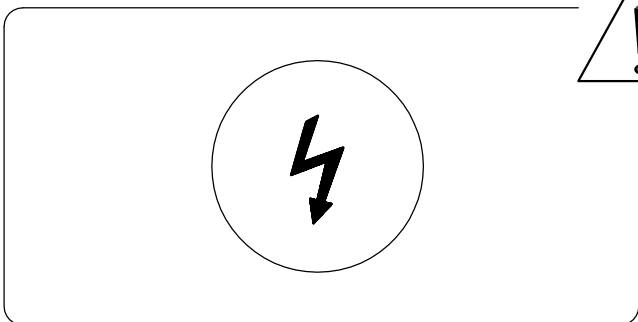

1

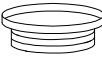
1/6

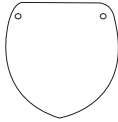
<b>A</b>  <b>x 1</b>	<b>B</b>  <b>x 1</b>	<b>1</b>  <b>x 5</b>	<b>2</b>  <b>x 5</b>	<b>3</b>  <b>x 5</b>
---	---	---	---	---

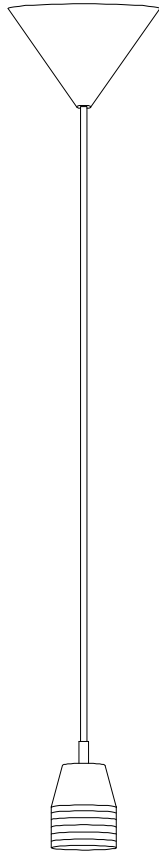

**A**

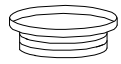

**B**

4

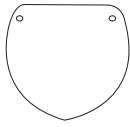

x 5

5

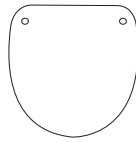

x 5

6

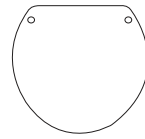

x 5

7

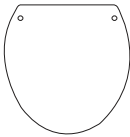

x 5

8

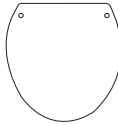

x 5

9

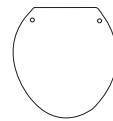

x 5

10

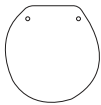

x 5

11

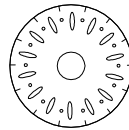

x 1

12

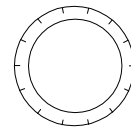

x 1

13



x 10

14

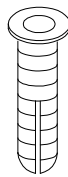

x 1

15



x 1



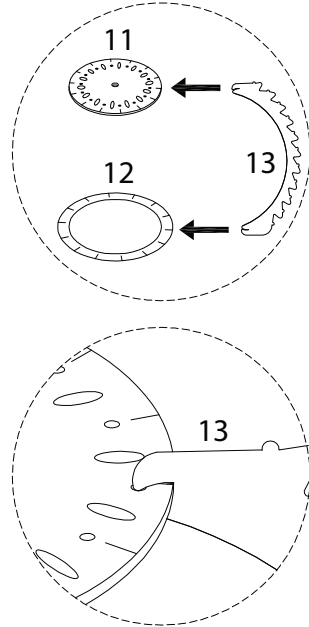
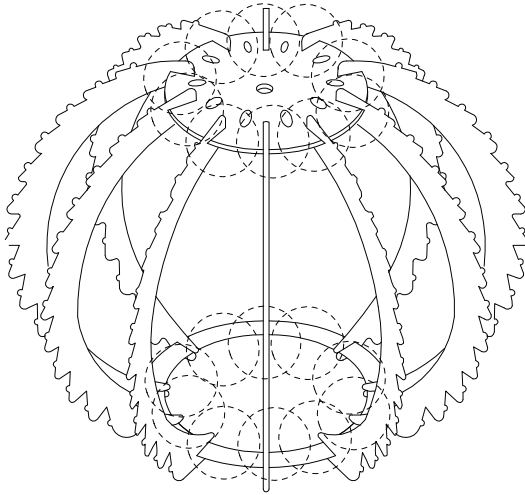
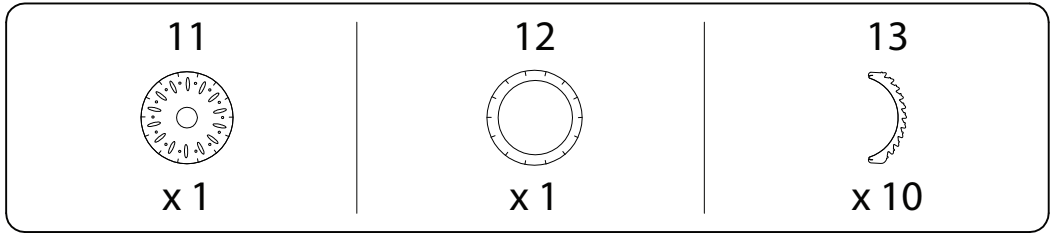



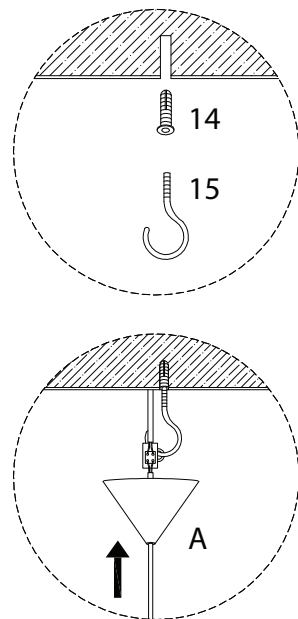
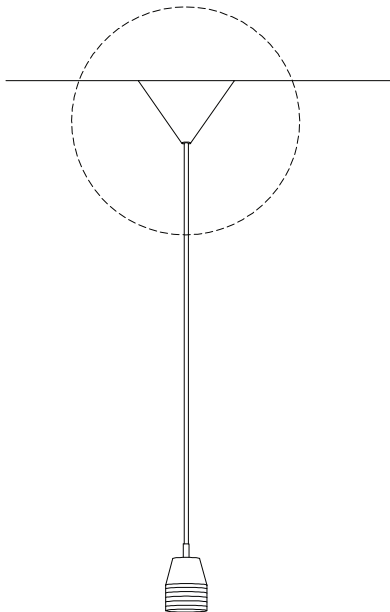
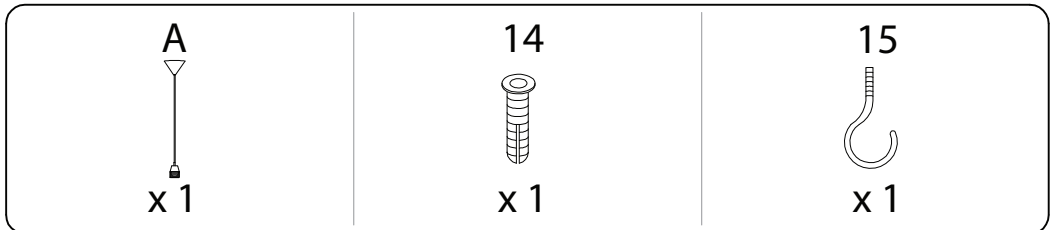



1



2



3 x 5

1  x1	2  x1	3  x1	4  x1	5  x1
6  x1	7  x1	8  x1	9  x1	10  x1

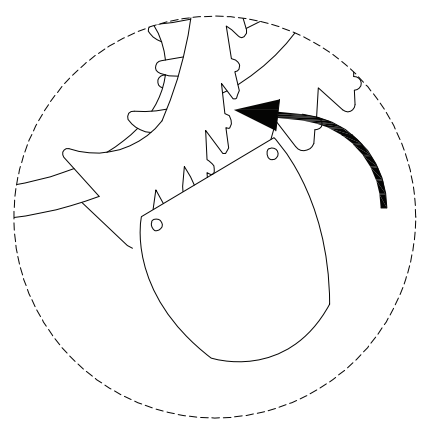
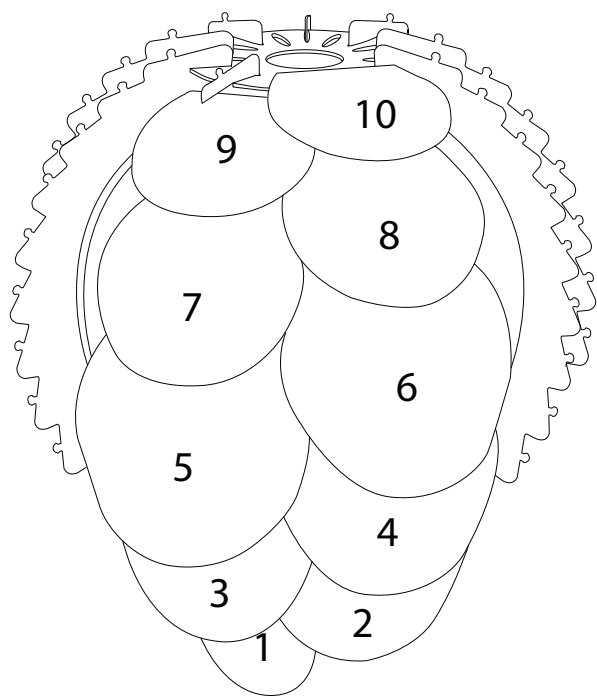

4

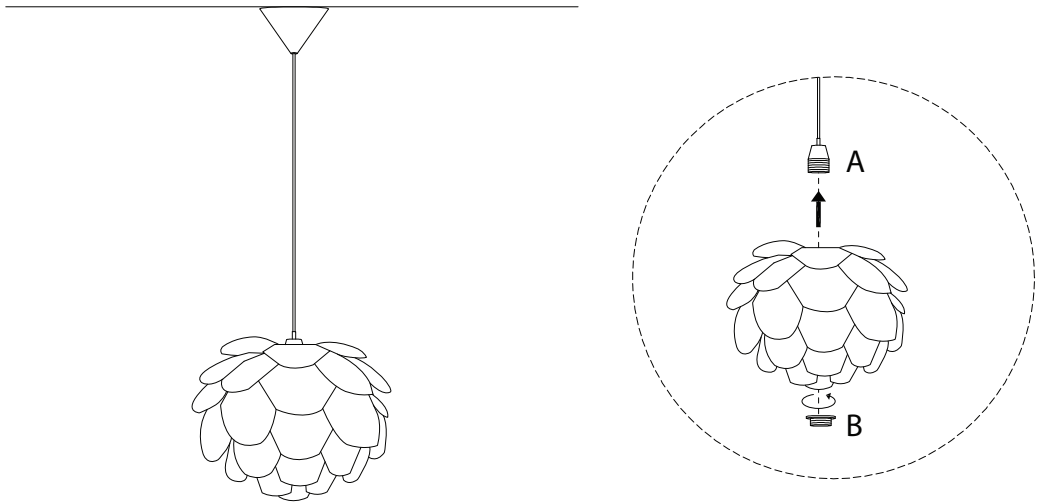
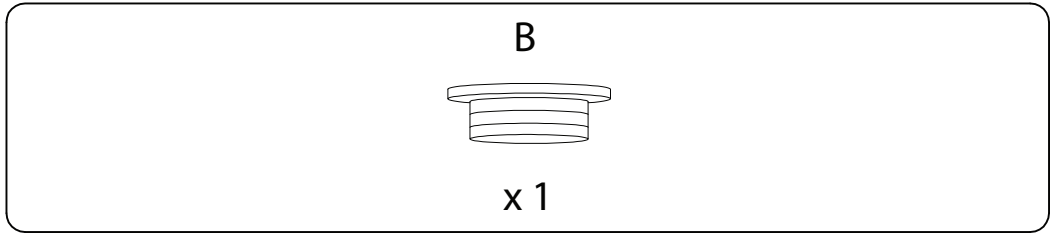

5

