

10'

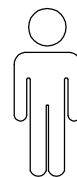
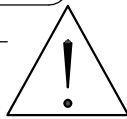
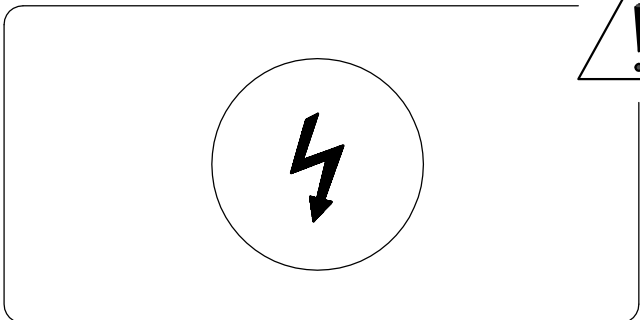

1

1/3

A

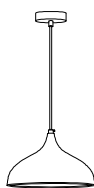

x 1

A

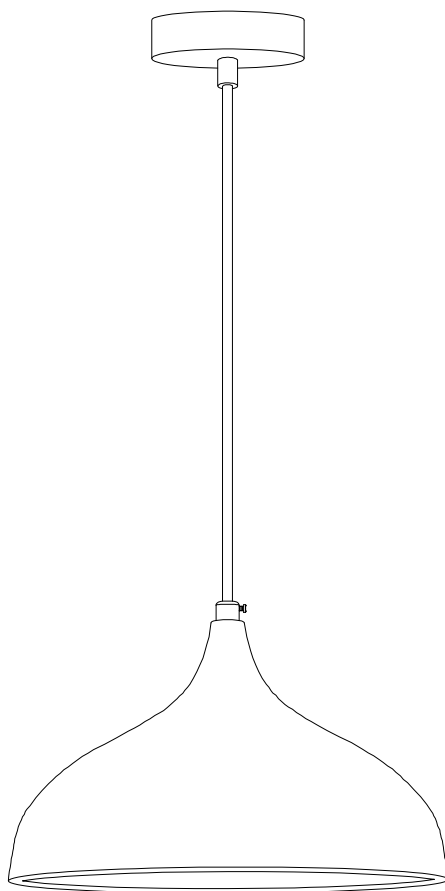

B

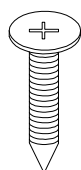

x 2

C



x 2

1

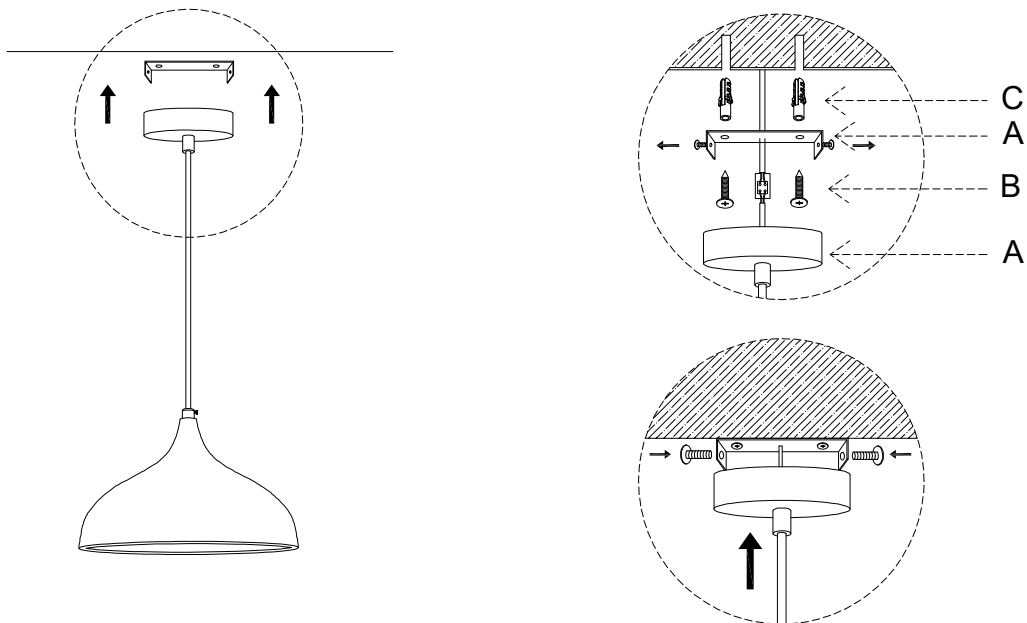
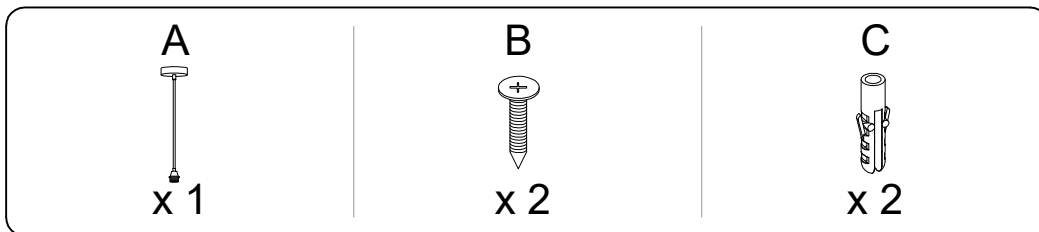

2

