

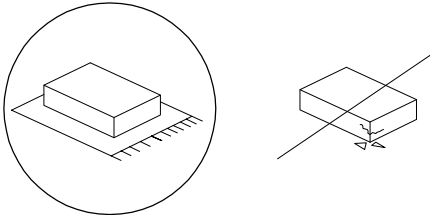

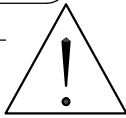

		<b>30'</b>
		
		<b>1</b>

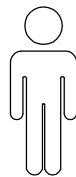
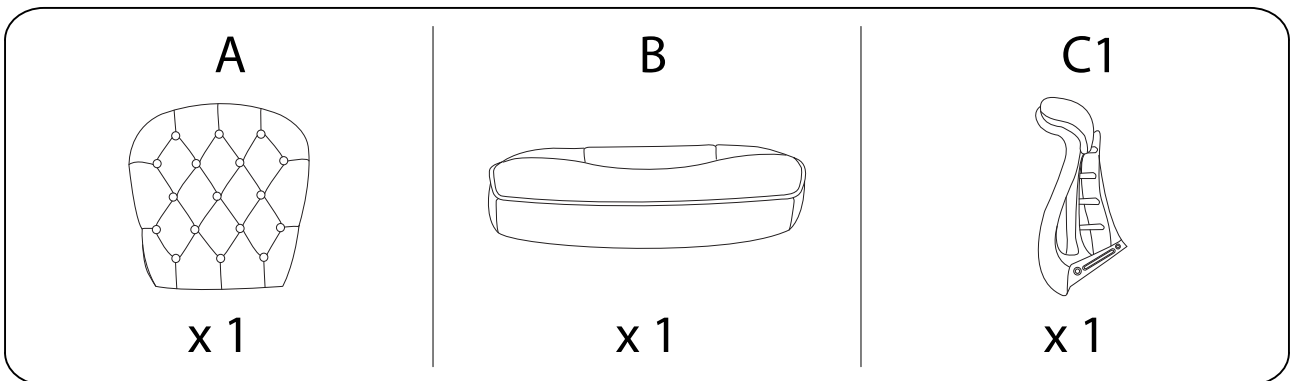
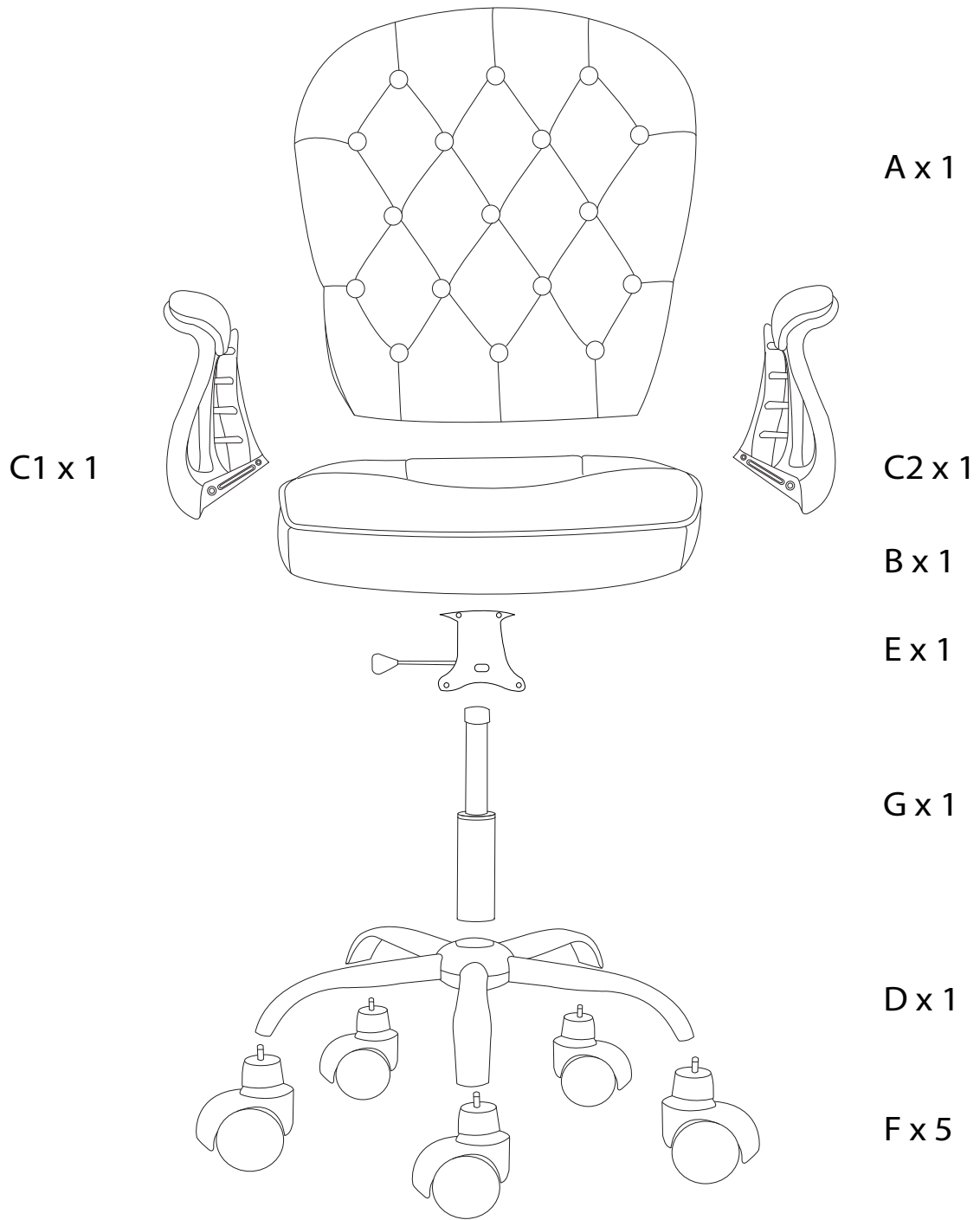
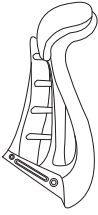
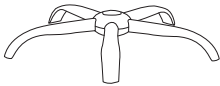
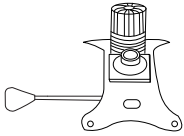

<p><b>C2</b></p>  <p><b>x 1</b></p>	<p><b>D</b></p>  <p><b>x 1</b></p>	<p><b>E</b></p>  <p><b>x 1</b></p>	<p><b>F</b></p>  <p><b>x 5</b></p>	<p><b>G</b></p>  <p><b>x 1</b></p>
<p><b>H</b></p>  <p><b>M6 x 30</b></p> <p><b>x 8</b></p>	<p><b>I</b></p>  <p><b>M6 x 20</b></p> <p><b>x 4</b></p>	<p><b>J</b></p>  <p><b>x 8</b></p>	<p><b>K</b></p>  <p><b>x 1</b></p>	<p><b>L</b></p>  <p><b>x 4</b></p>

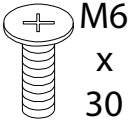
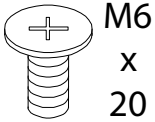
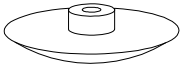
1

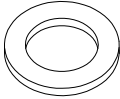
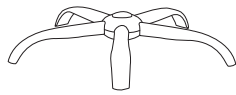
D



x 1

F



x 5

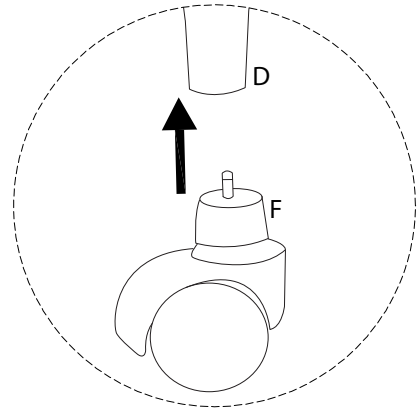
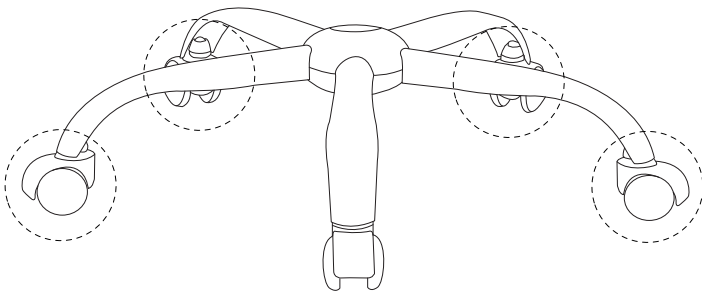

2

B



x 1

E

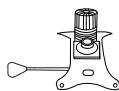

x 1

I



x 4

K



x 1



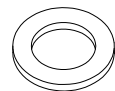

L

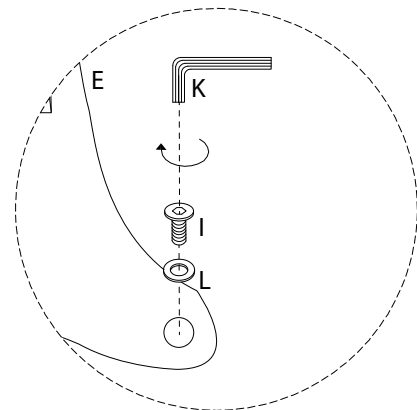
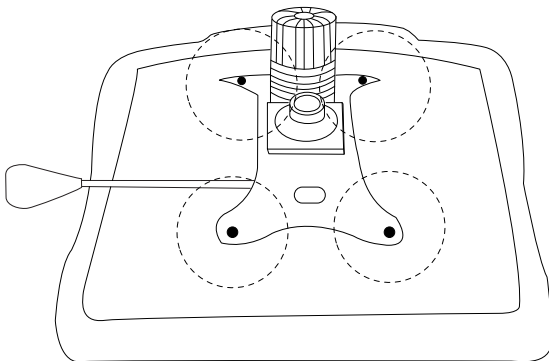

x 4

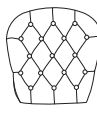

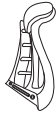
3

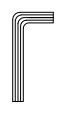
<b>A</b>  x 1	<b>C1</b>  x 1	<b>C2</b>  x 1	<b>H</b>  M6 x 30 x 8	<b>J</b>  x 8	<b>K</b>  x 1
--	---	---	---	--	--

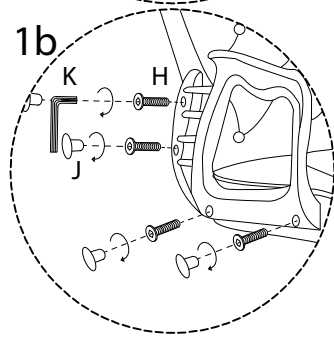
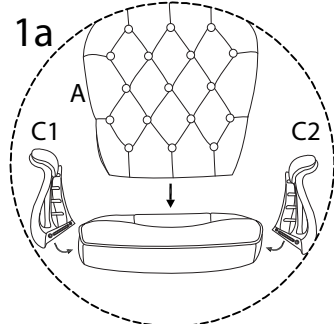
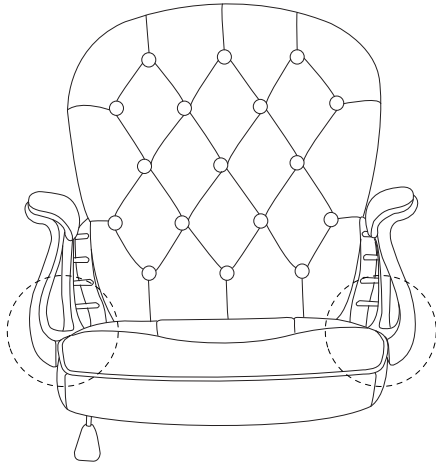

4

