

Assembly instructions for the chair, including warnings, time, and person icons.

Warning 1: Do not use a power drill. Use an Allen key (shown in a circle) to tighten the backrest.

Warning 2: Do not use a power drill to tighten the seat. Use a screwdriver (shown in a circle) to tighten the seat.

Time: 15'

Person: 1

A

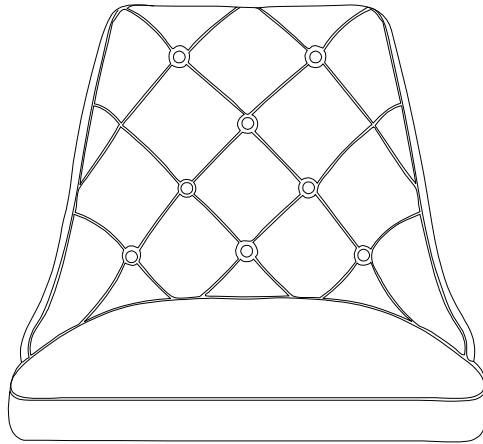

B x 2

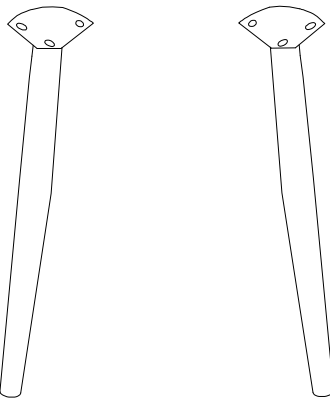

C x 2

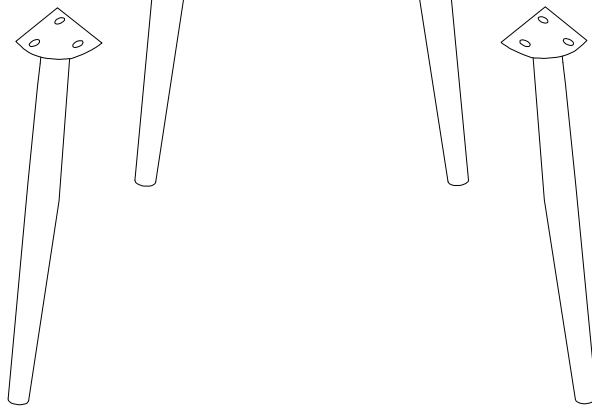

A

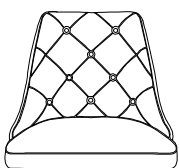

x 1

B



x 2

C



x 2

D

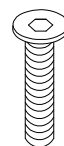

M6
x
20

x 12

E

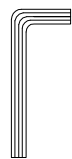

x 1

1

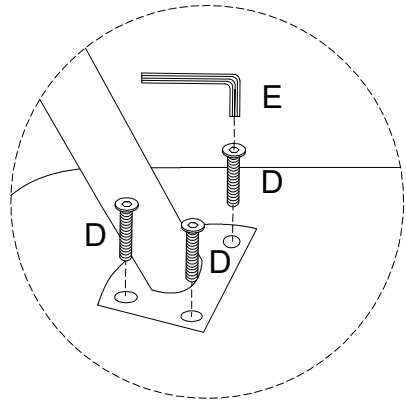
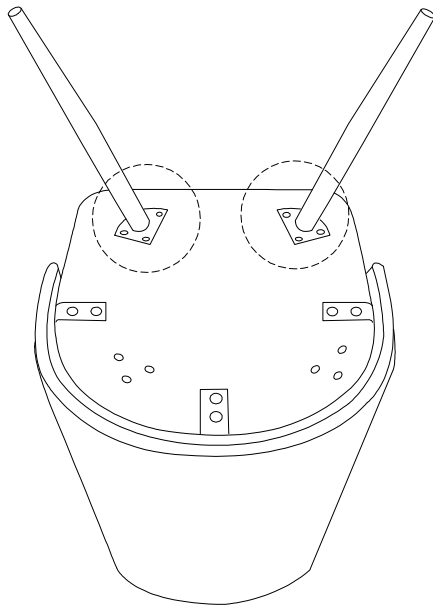
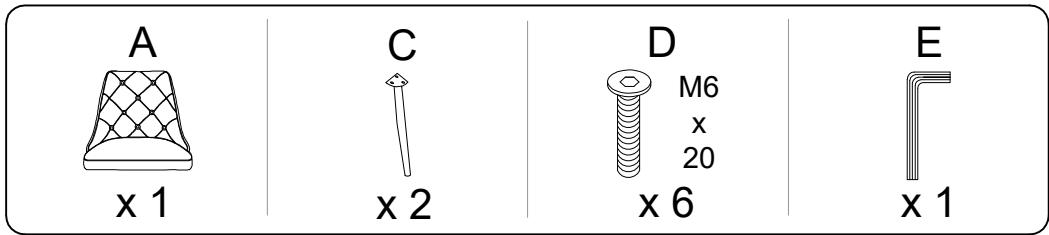

2

