

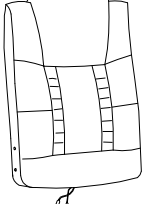

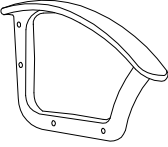





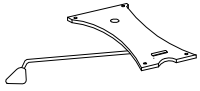

An L-shaped metal bracket is shown inside a circle. To its right is a power drill with a diagonal line through it, indicating it should not be used.	A triangle with an exclamation mark inside, indicating a warning.	A circular clock face with tick marks around the perimeter.
<p>30'</p>	A triangle with an exclamation mark inside, indicating a warning.	A simple line drawing of a person standing.
A rectangular block is shown on a surface with a hatched pattern. To its right is the same block with a screw being inserted into it, crossed out with a diagonal line.	<p>1</p>	

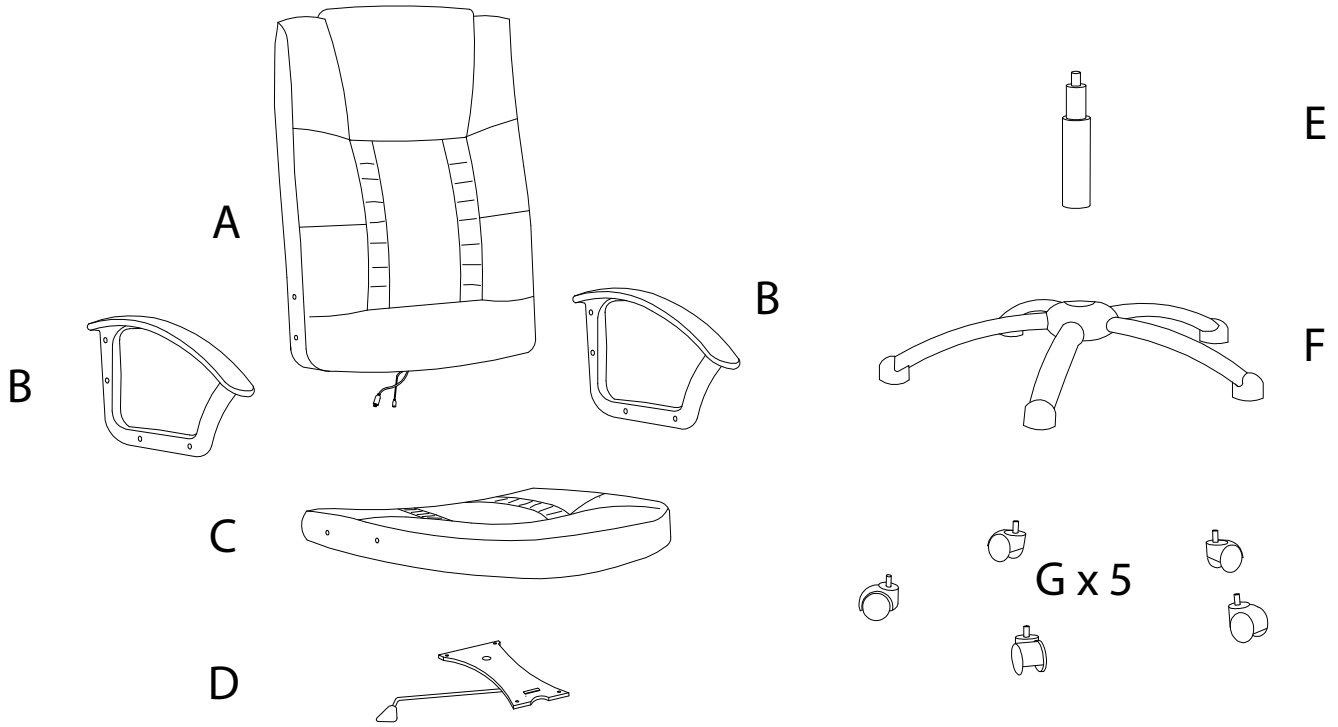
A  x 1	B  x 2	C  x 1	D  x 1	E  x 1
---	---	---	--	---

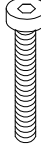
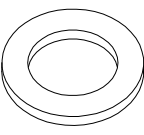

F  x 1	G  x 5	H  x 8	I  M6 x 20 x 12
J  x 4	K  x 1	L  x 1	M  x 1

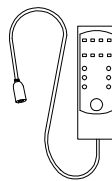
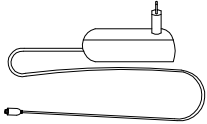
1

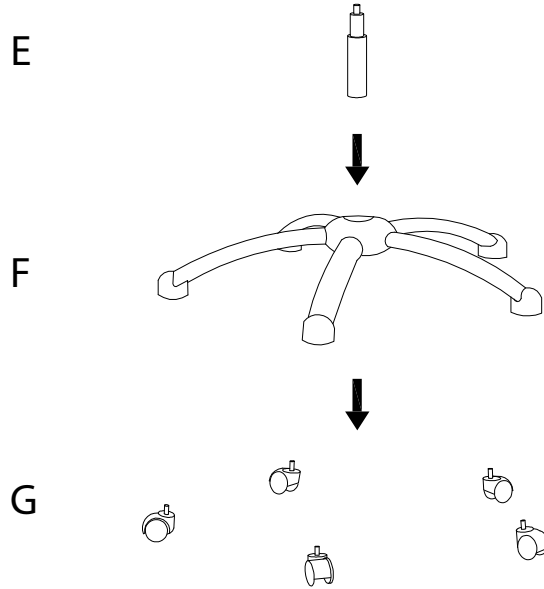
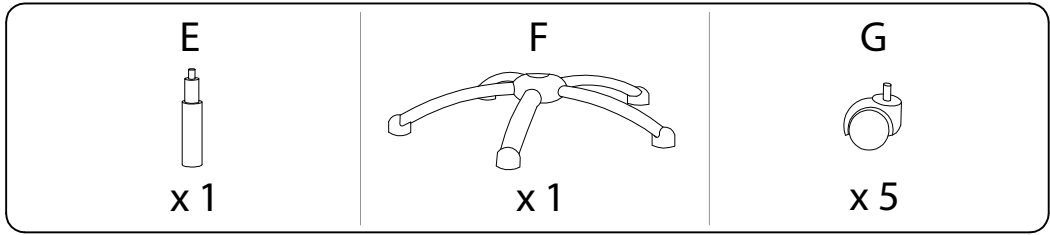

2

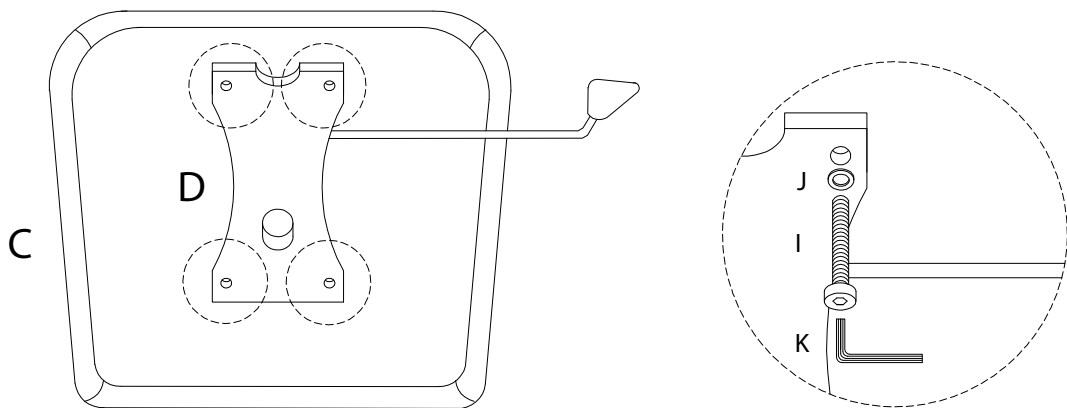
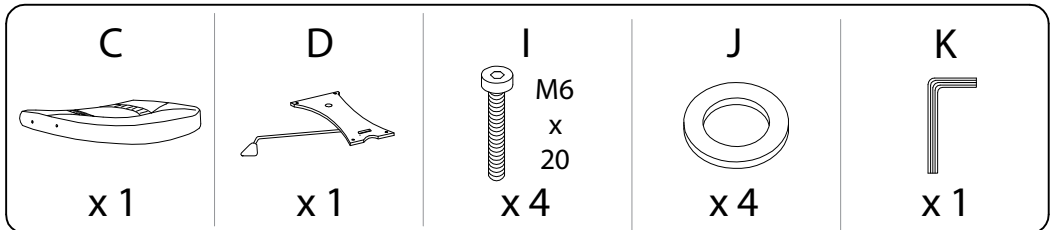

3

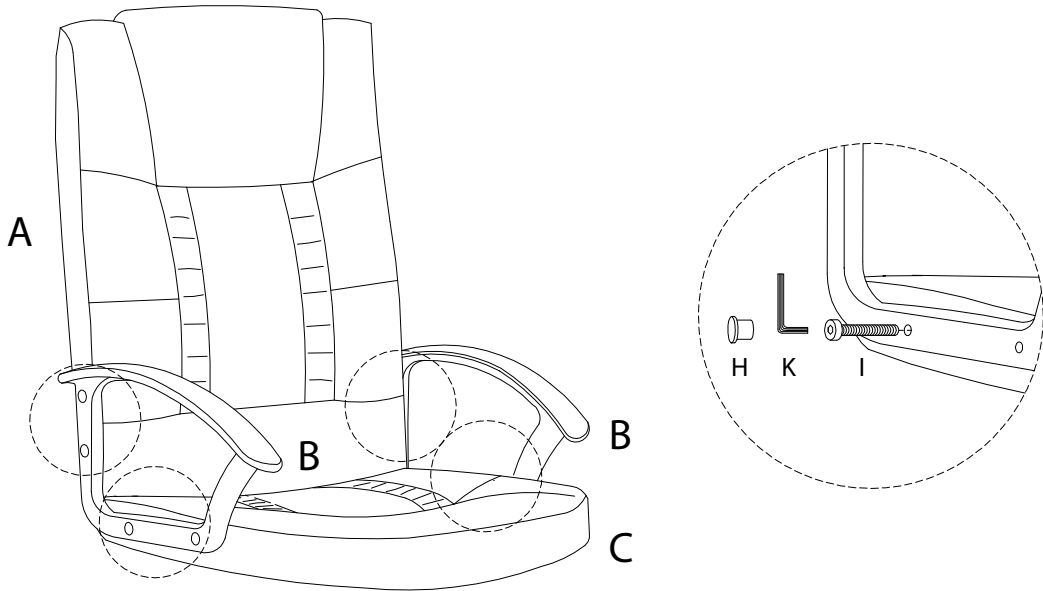
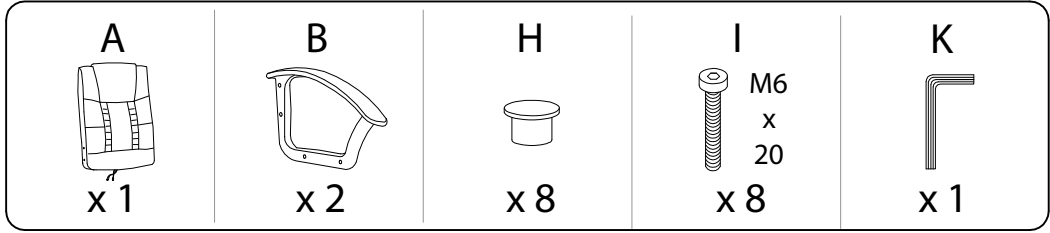

4

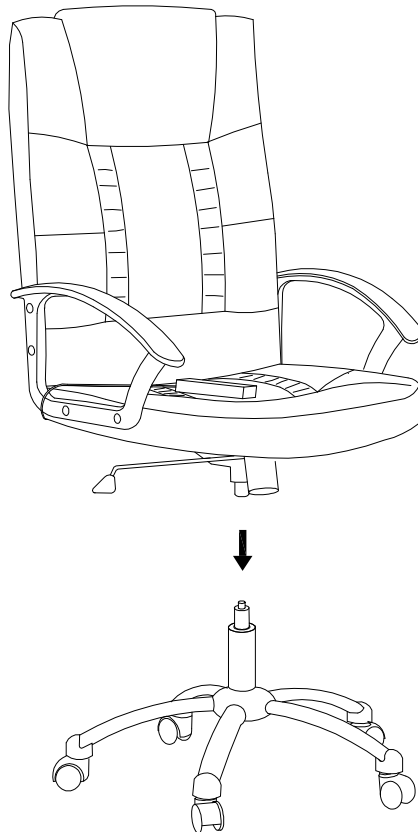

5

L

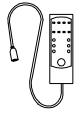

x 1

M

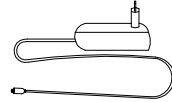

x 1

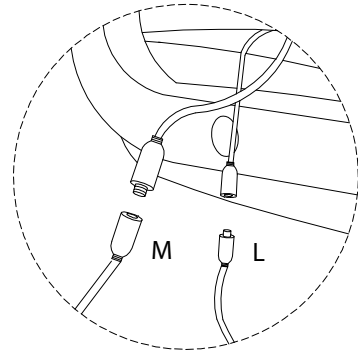
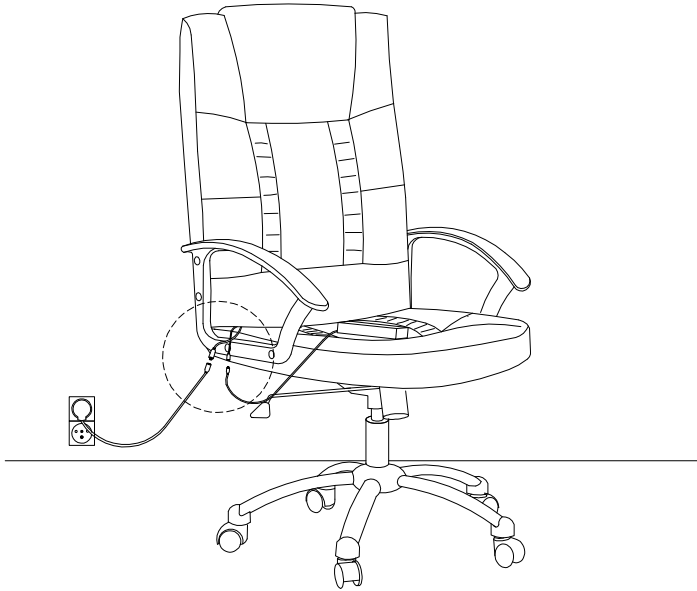

!

