

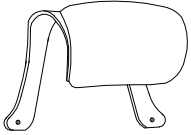

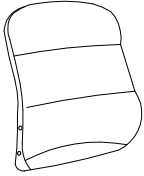





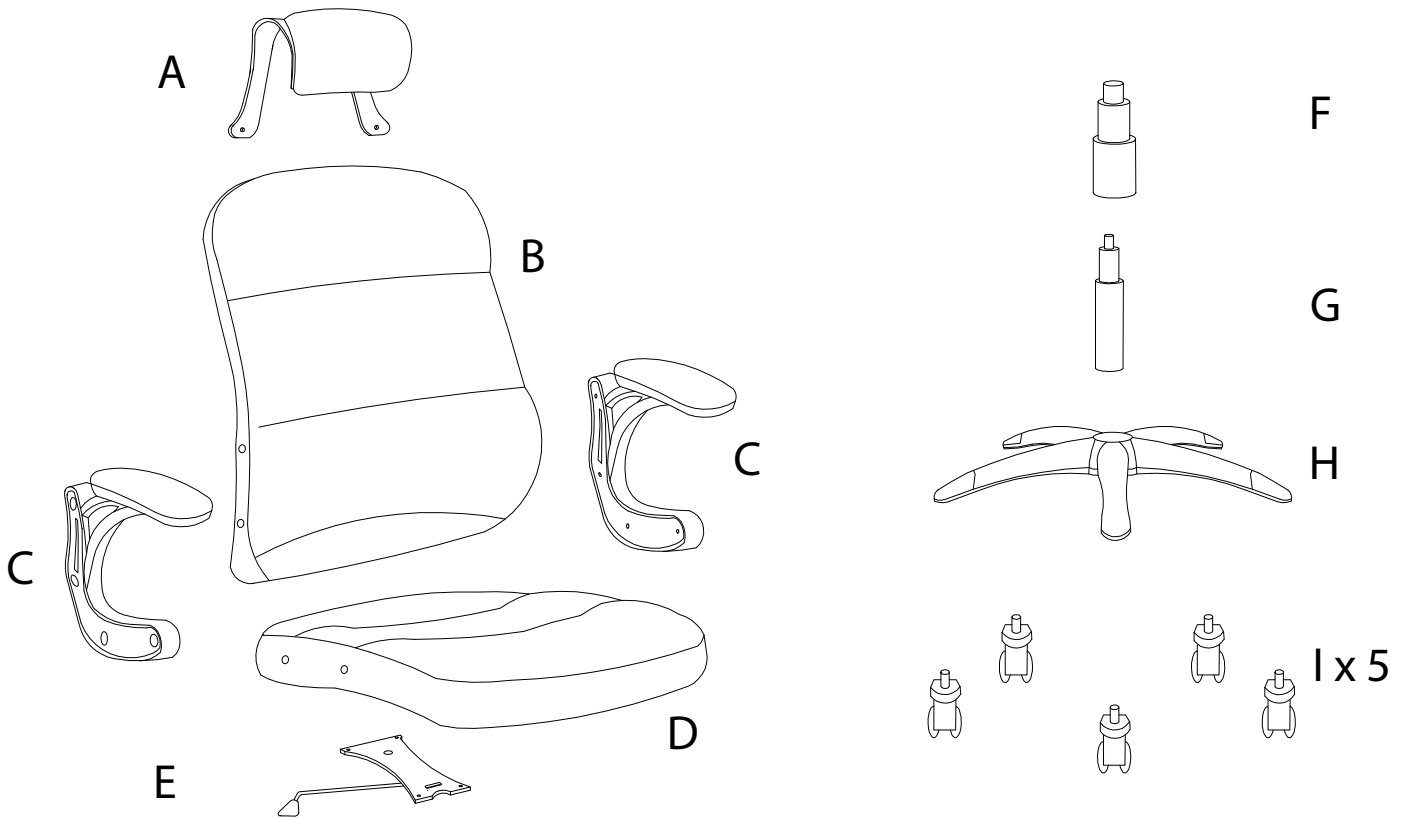

|  |  |   |
|--|--|---|
| An L-shaped metal bracket is shown inside a circle. To its right is a power drill with a diagonal line through it, indicating it should not be used. | A warning triangle containing an exclamation mark. | A clock face showing approximately 12:30. |
| A rectangular block is shown on a mat with a diagonal line through it, indicating it should not be used on the mat.                                  | A warning triangle containing an exclamation mark. | A simple icon of a person.                |

30'

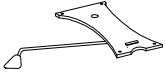
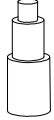
1

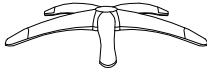
|   |   |  |   |
|---|---|--|---|
| <b>A</b>  | <b>B</b>  | <b>C</b>   | <b>D</b>  |
|  |  |  |  |
| <b>x 1</b>  | <b>x 1</b>  | <b>x 2</b>   | <b>x 1</b>  |

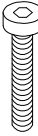

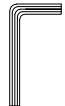
|   |  |  |   |   |
|---|--|--|---|---|
| <b>E</b>  | <b>F</b>   | <b>G</b>   | <b>H</b>  | <b>I</b>  |
|  |             |             |             |  |
| <b>x 1</b>  | <b>x 1</b>   | <b>x 1</b>   | <b>x 1</b>  | <b>x 5</b>  |
| <b>J</b>  | <b>K</b>   | <b>L</b>   | <b>M</b>  | <b>N</b>  |
|  |  M6<br>x 30 |  M6<br>x 20 |  M6<br>x 35 |  |
| <b>x 8</b>  | <b>x 8</b>   | <b>x 4</b>   | <b>x 2</b>  | <b>x 1</b>  |

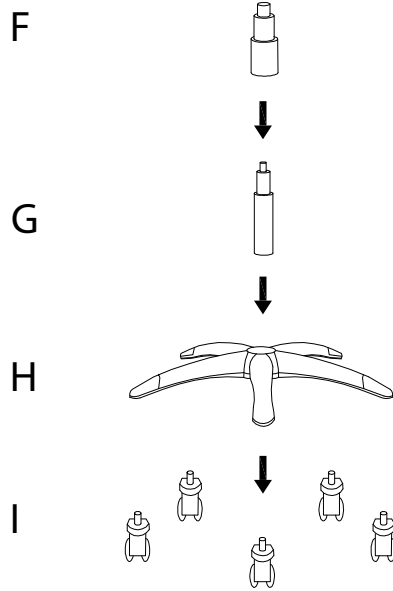
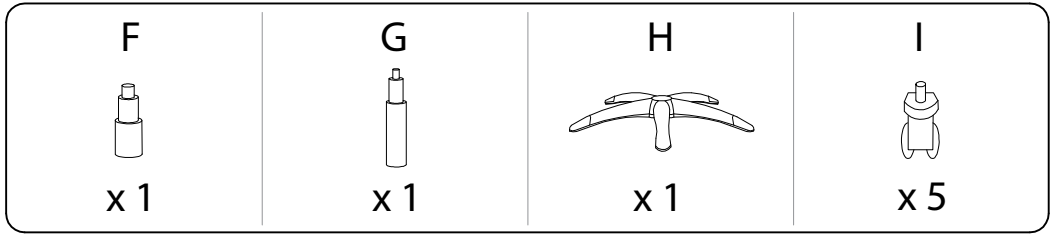

1

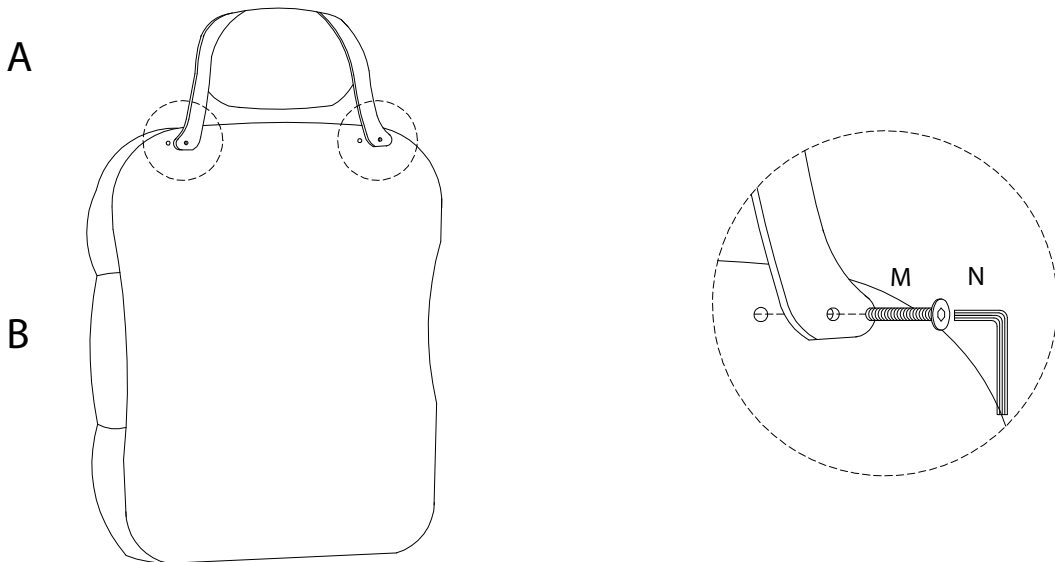
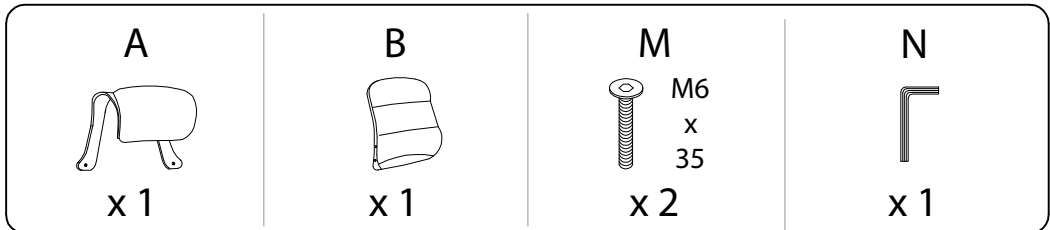

2



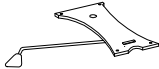

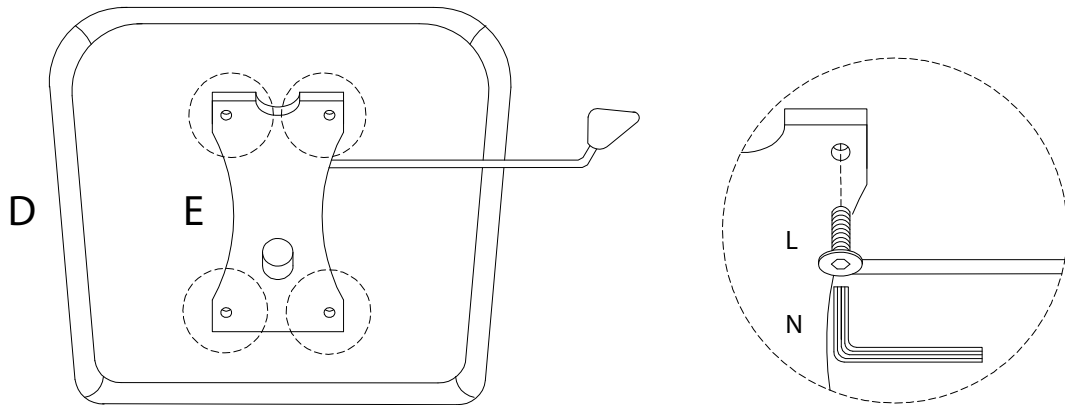

3

|  |  |  |  |
|--|--|--|--|
| <p>D</p>  <p>x1</p> | <p>E</p>  <p>x1</p> | <p>L</p> <p>M6<br/>x<br/>20</p>  <p>x4</p> | <p>N</p>  <p>x1</p> |
|--|--|--|--|



4

|  |  |  |  |
|--|--|--|--|
| <p>C</p>  <p>x2</p> | <p>J</p>  <p>x8</p> | <p>K</p> <p>M6<br/>x<br/>30</p>  <p>x8</p> | <p>N</p>  <p>x1</p> |
|--|--|--|--|

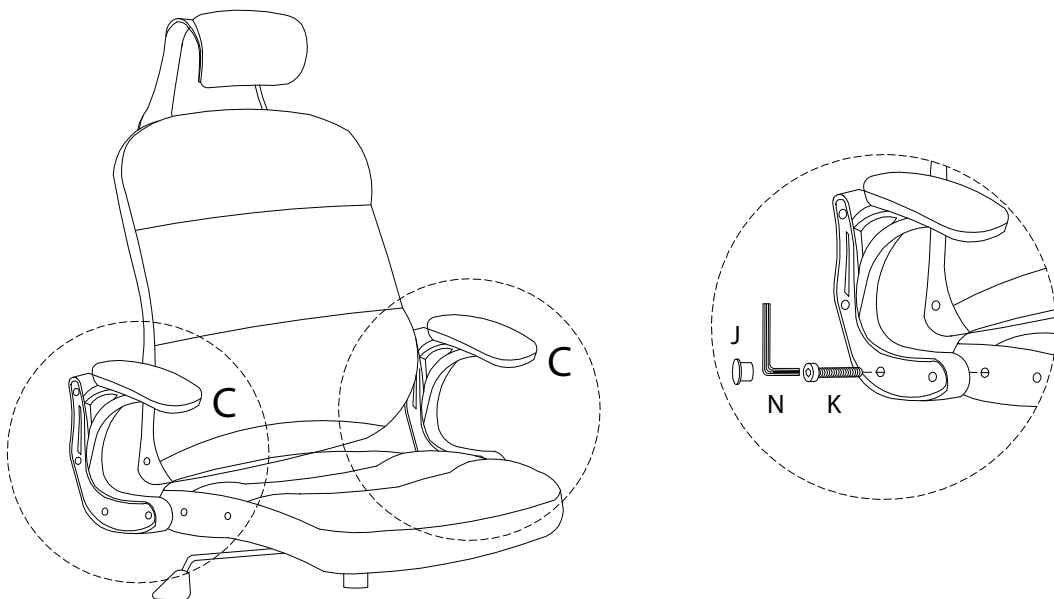

5

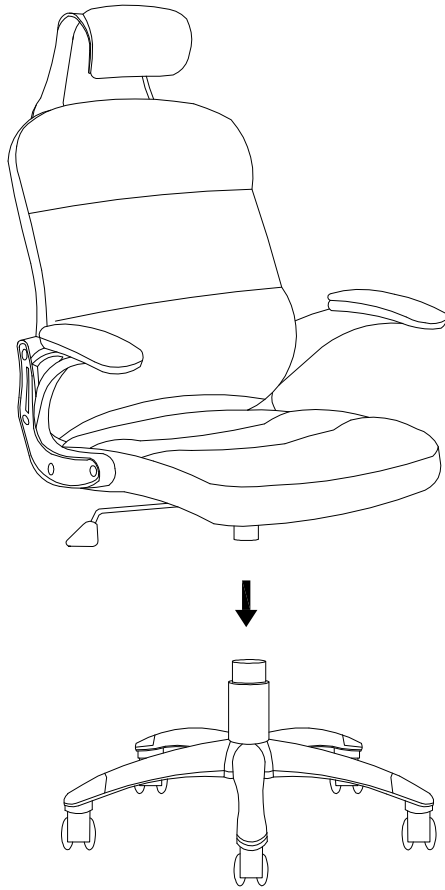

!

