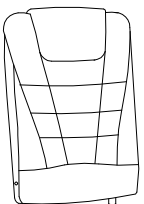
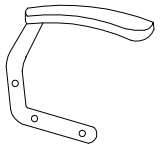
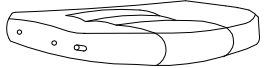

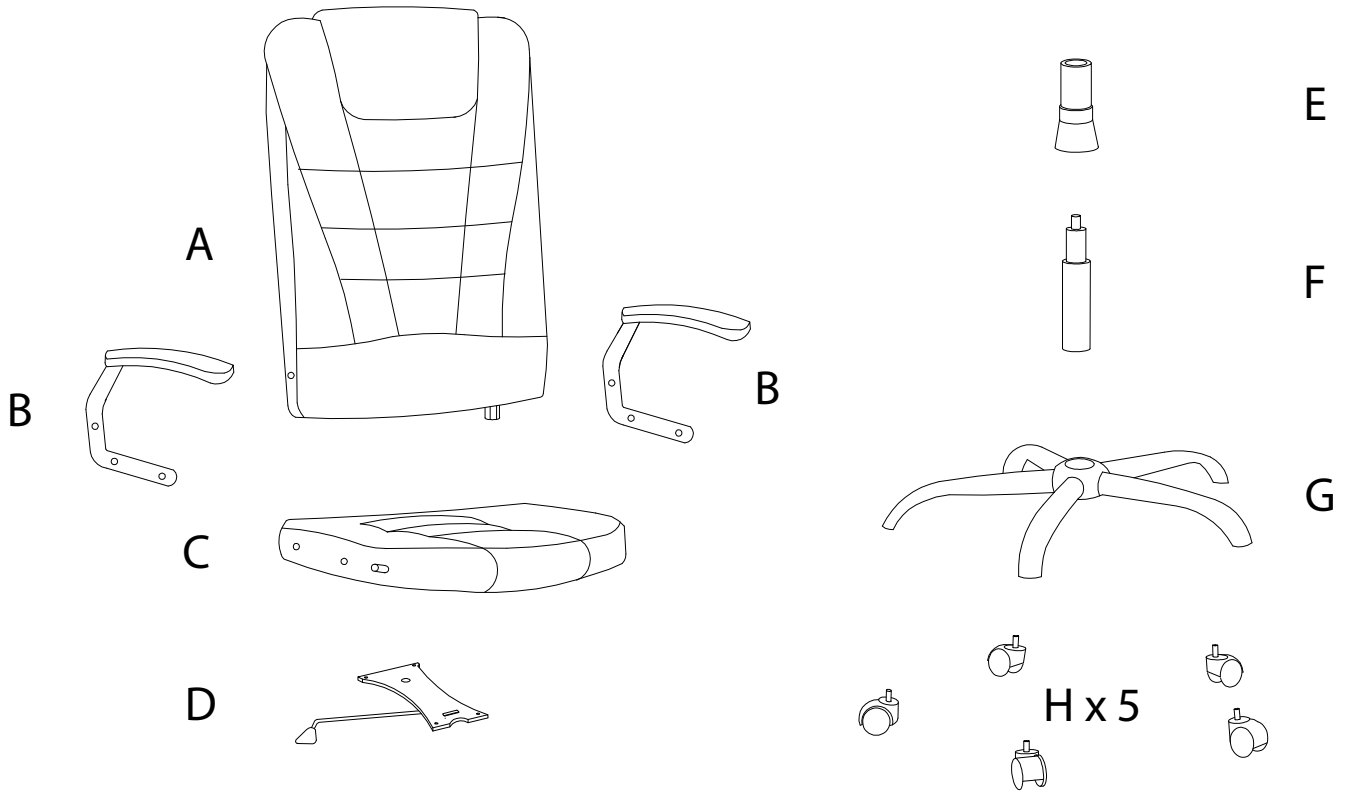

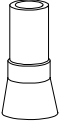
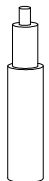



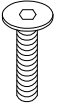
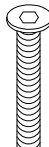

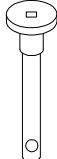
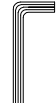

Diagram illustrating assembly instructions and safety warnings:

- Warning 1:** A triangle with an exclamation mark. To its left, a box contains an L-shaped bracket and a crossed-out power drill, indicating that the bracket should be installed without using a power drill.
- Warning 2:** A triangle with an exclamation mark. To its left, a box contains a rectangular block being placed on a surface and a crossed-out block with a screw, indicating that the block should be placed on a soft surface and not fastened with a screw.
- Time:** A clock icon with the text "30'" below it, indicating an estimated assembly time of 30 minutes.
- Person:** A stick figure icon with the number "1" below it, indicating that one person is required for assembly.

<b>A</b>  <b>x 1</b>	<b>B</b>  <b>x 2</b>	<b>C</b>  <b>x 1</b>	<b>D</b>  <b>x 1</b>
---	---	--	---



<b>E</b>  <b>x 1</b>	<b>F</b>  <b>x 1</b>	<b>G</b>  <b>x 1</b>	<b>H</b>  <b>x 5</b>	<b>I</b>  <b>x 6</b>
<b>J</b>  <b>M6</b> <b>x 20</b> <b>x 4</b>	<b>K</b>  <b>M8</b> <b>x 30</b> <b>x 6</b>	<b>L</b>  <b>x 1</b>	<b>M</b>  <b>x 1</b>	<b>N</b>  <b>x 1</b>

1

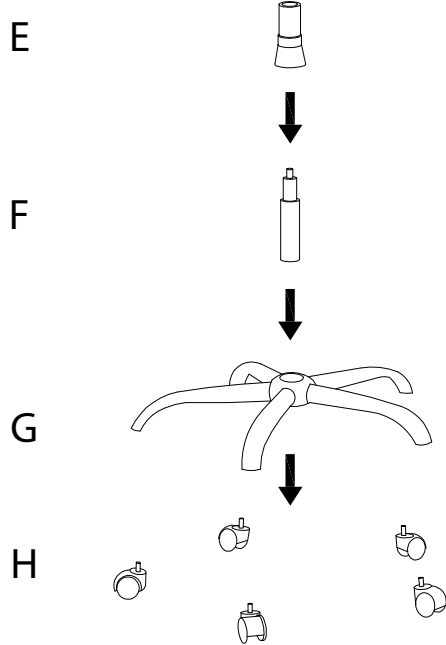
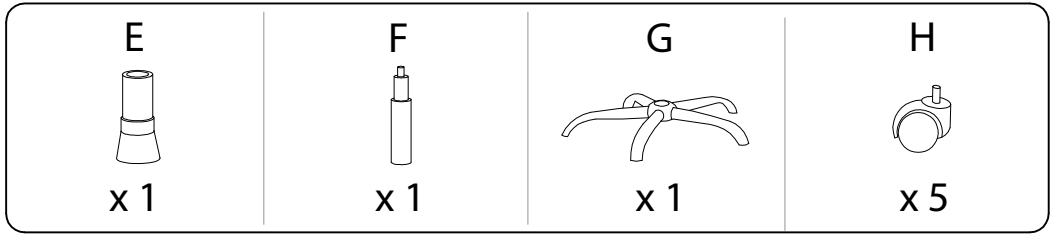

2

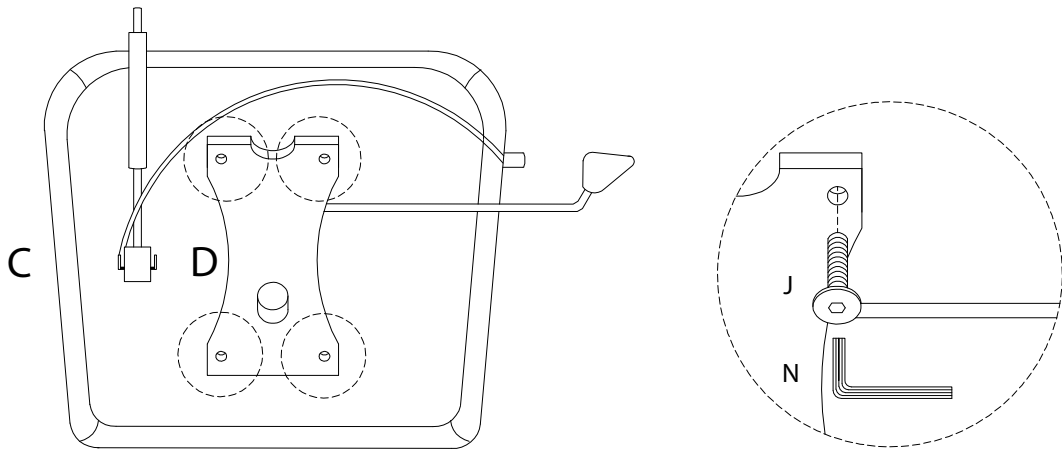
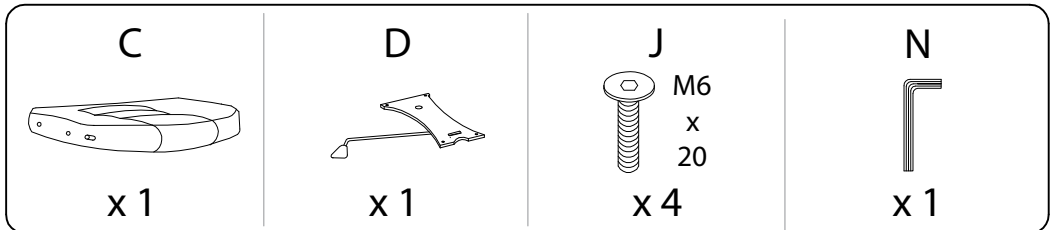

3

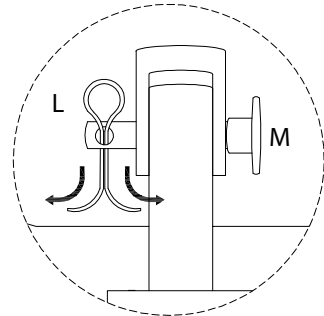
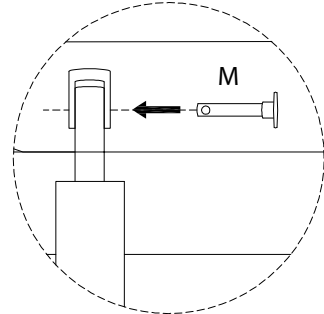
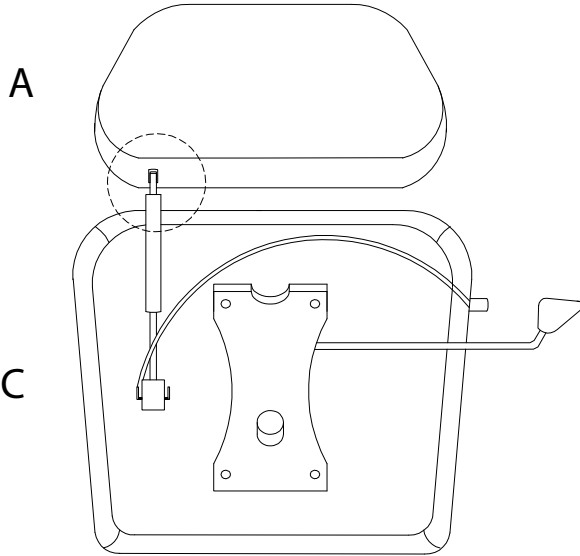
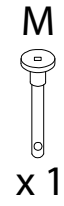
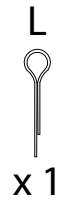

4

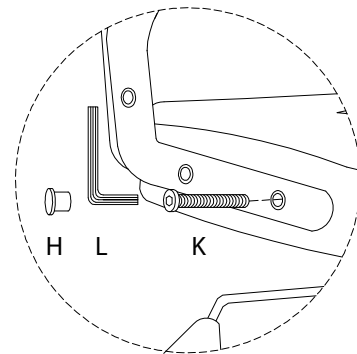
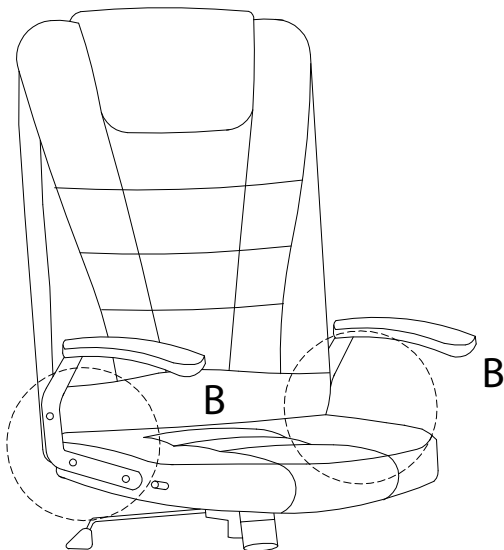
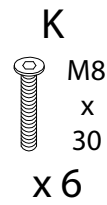

5

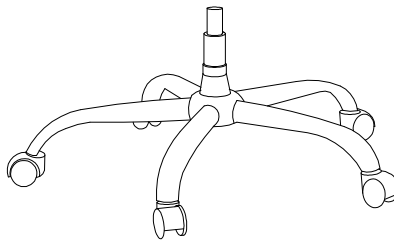
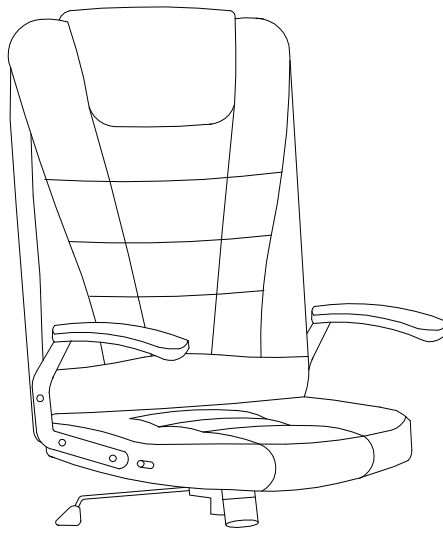

!

