

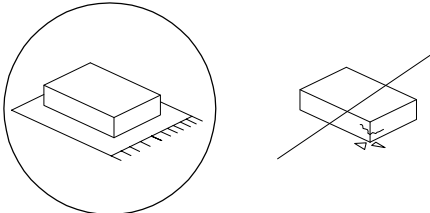

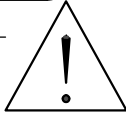

		15'
		
		1

<p>A</p>  <p>x 1</p>	<p>B</p>  <p>x 1</p>	<p>C</p>  <p>M6 x 25</p> <p>x 2</p>
---	---	--

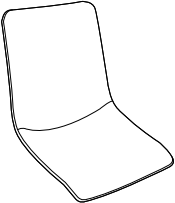
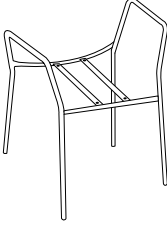

A

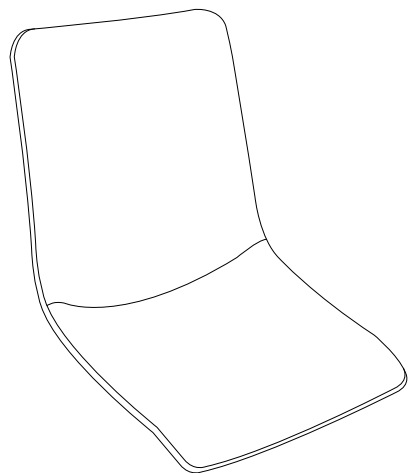
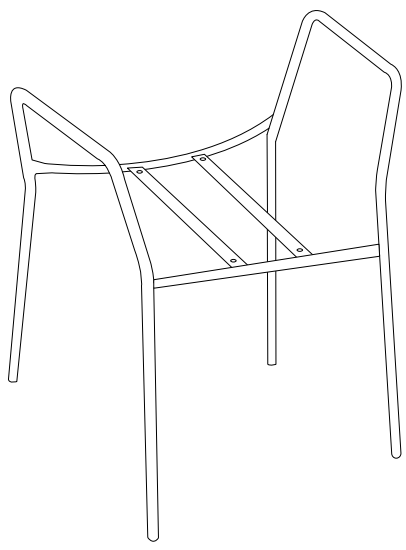

B

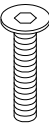
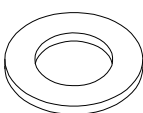
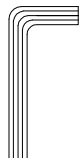
<p>D</p>  <p>M6 x 30</p> <p>x 2</p>	<p>E</p>  <p>x 4</p>	<p>F</p>  <p>x 1</p>
--	---	---

1

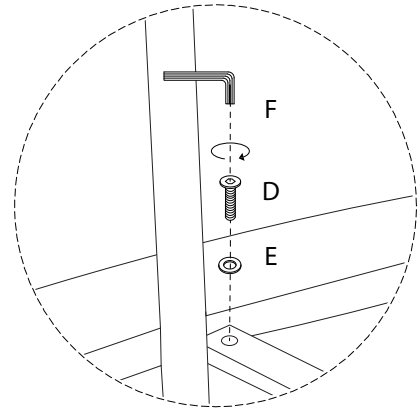
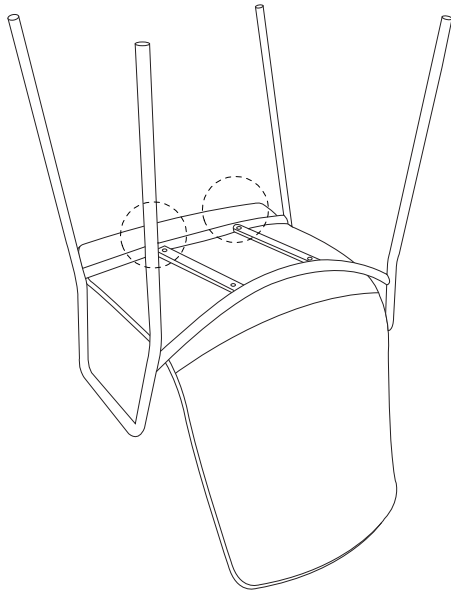
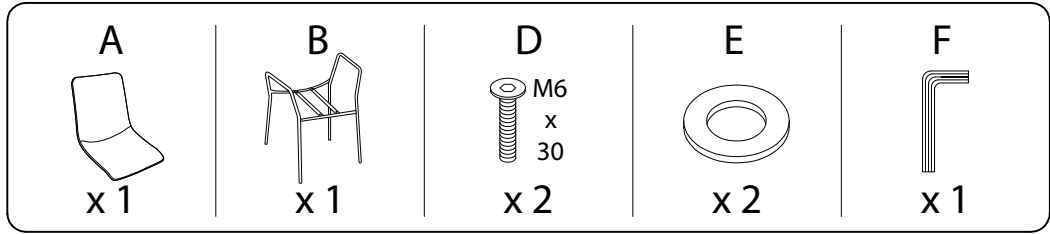

2

