

Assembly instructions for the chair, including safety warnings, tool requirements, and time/personnel estimates.

Warning 1: Do not use a power drill. Use an Allen key (shown in a circle) for assembly.

Warning 2: Do not use a power saw. Use a hand saw (shown in a circle) for assembly.

Time: 20'

Personnel: 1

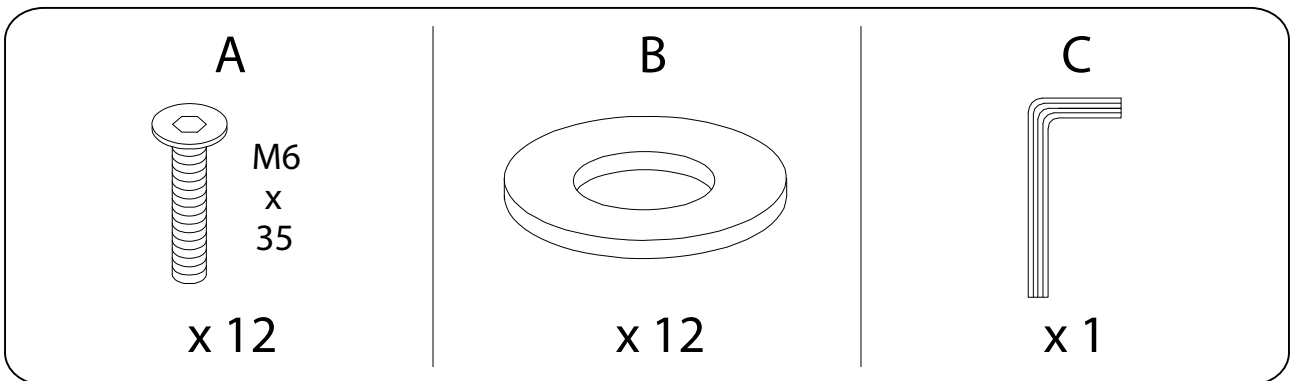
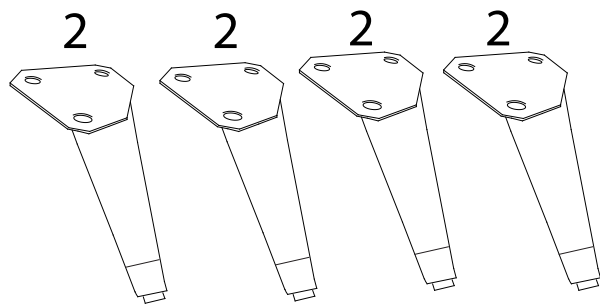
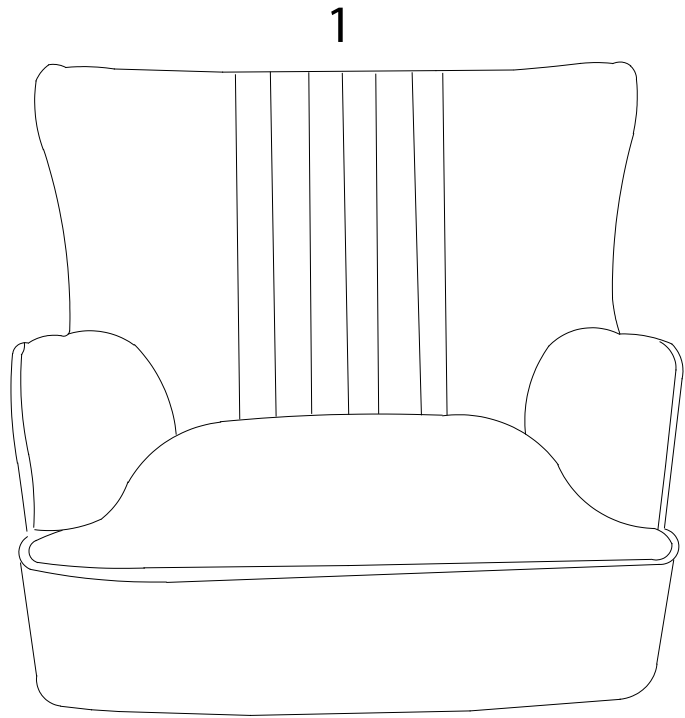
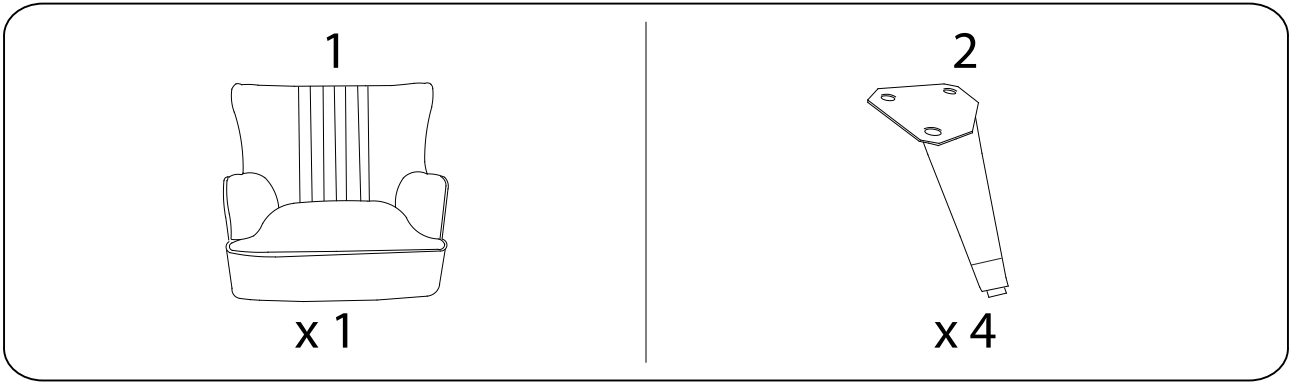

1

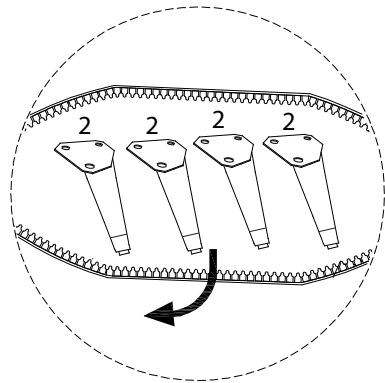
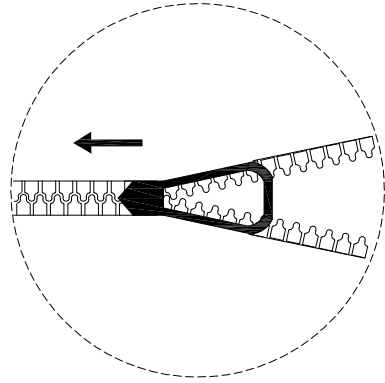
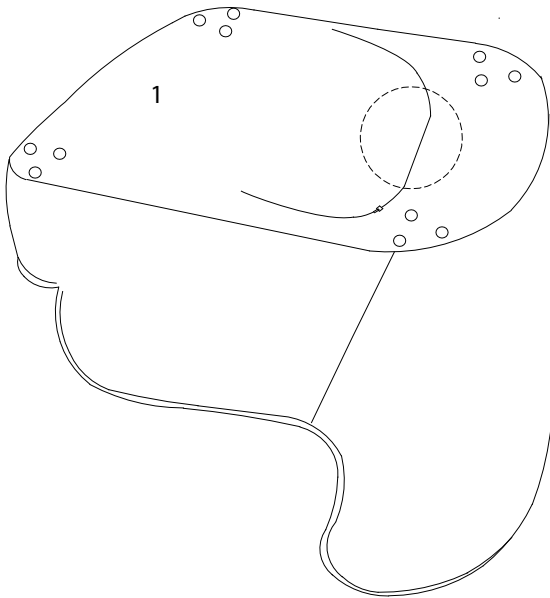

2

