

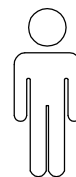

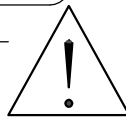

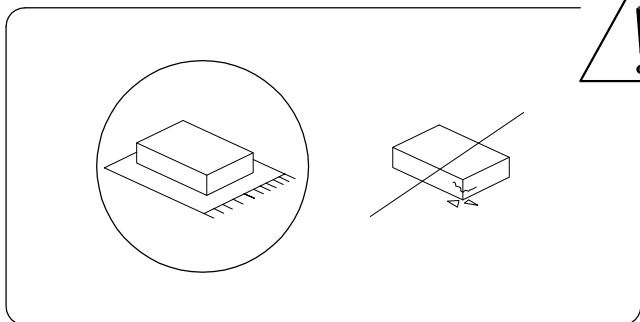

30'

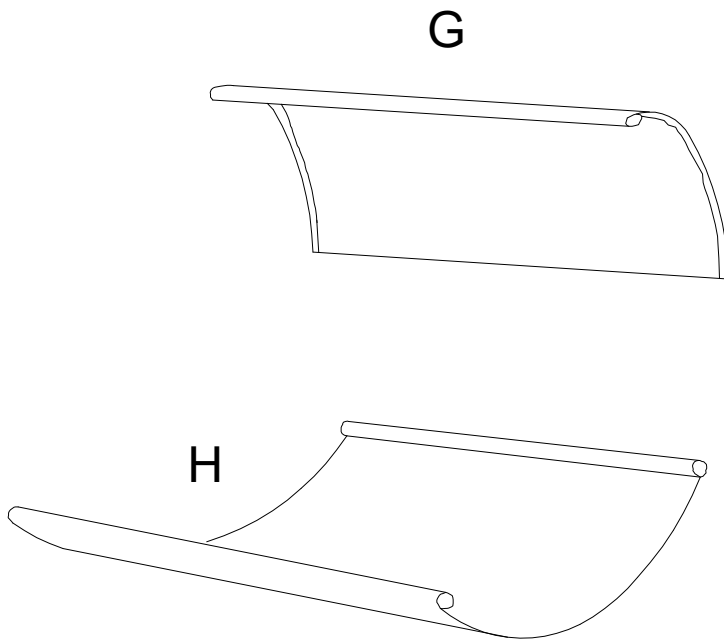
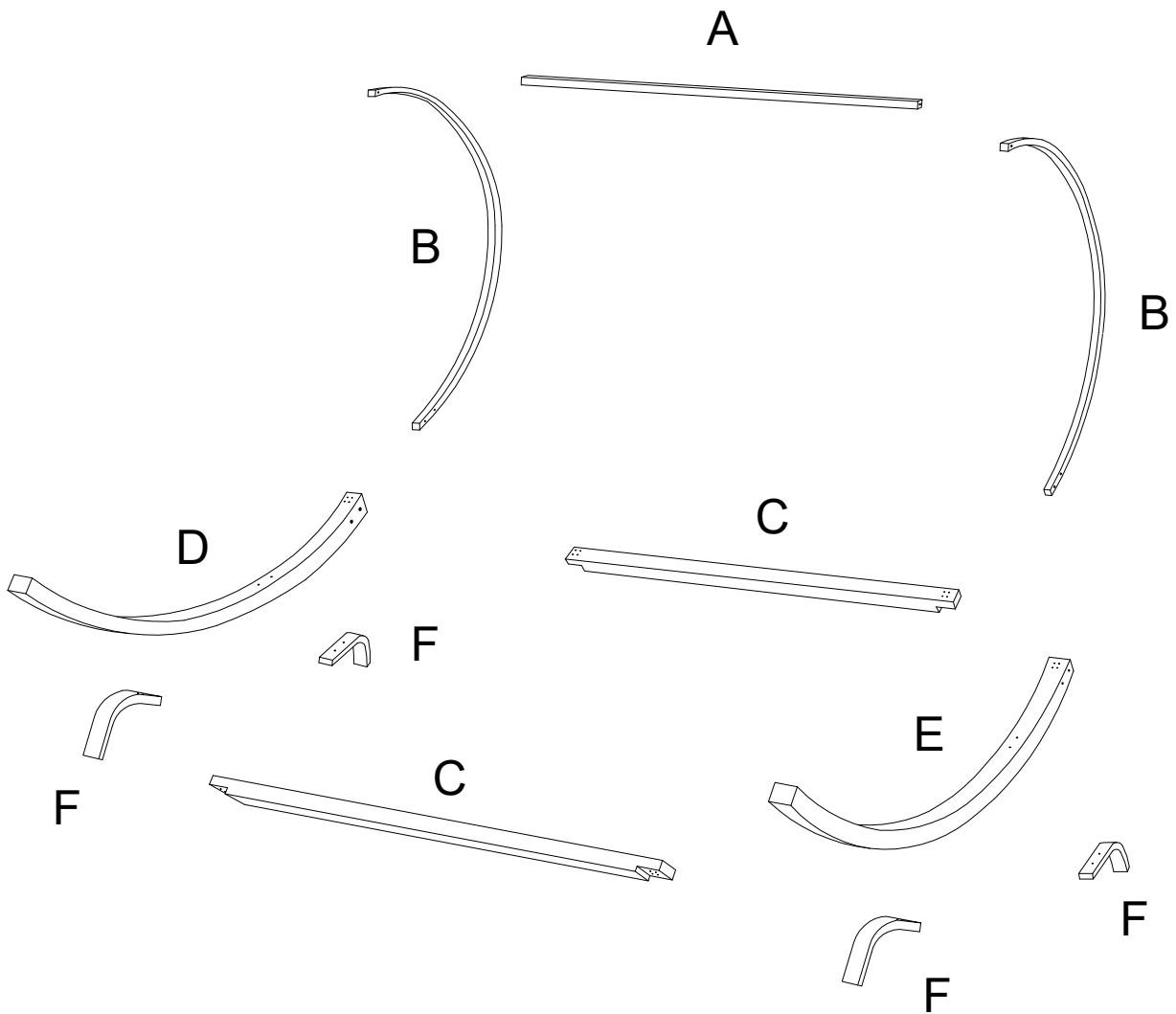

2

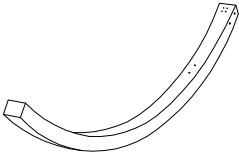
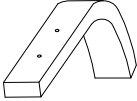
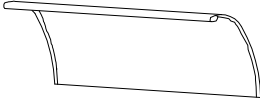
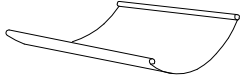
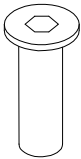
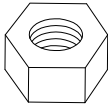
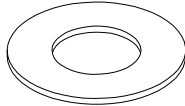
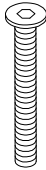
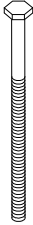
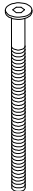
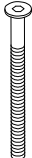

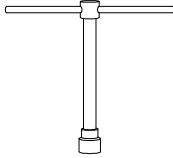

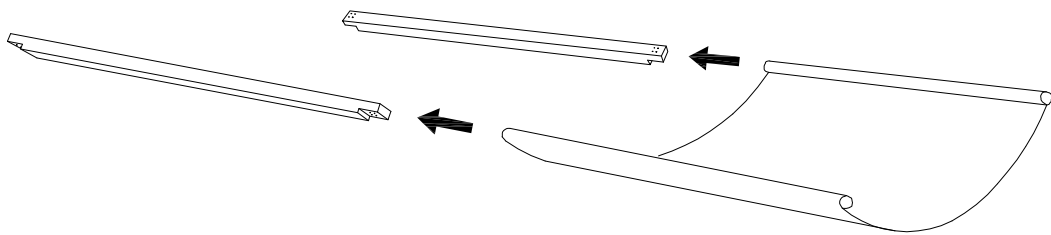
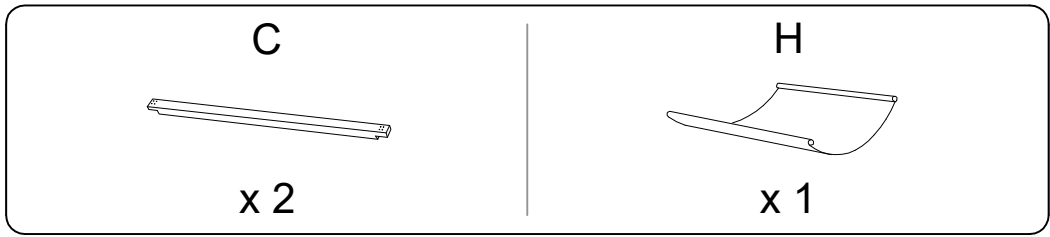

<p>A</p>  <p>x 1</p>	<p>B</p>  <p>x 2</p>	<p>C</p>  <p>x 2</p>	<p>D</p>  <p>x 1</p>	
<p>E</p>  <p>x 1</p>	<p>F</p>  <p>x 4</p>	<p>G</p>  <p>x 1</p>	<p>H</p>  <p>x 1</p>	
<p>I</p>  <p>x 20</p>	<p>J</p>  <p>x 8</p>	<p>K</p>  <p>x 8</p>	<p>L</p>  <p>M8 x 50</p> <p>x 2</p>	
<p>M</p>  <p>M10 x 130</p> <p>x 8</p>	<p>N</p>  <p>M8 x 100</p> <p>x 4</p>	<p>O</p>  <p>M8 x 90</p> <p>x 16</p>	<p>P</p>  <p>x 2</p>	<p>Q</p>  <p>x 2</p>

1

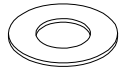
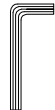
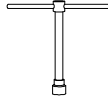

2

D  x 1	E  x 1	F  x 4	I  x 16	J  x 8
K  x 8	M M10 x 130 x 8	O M8 x 90 x 16	P  x 2	Q  x 2

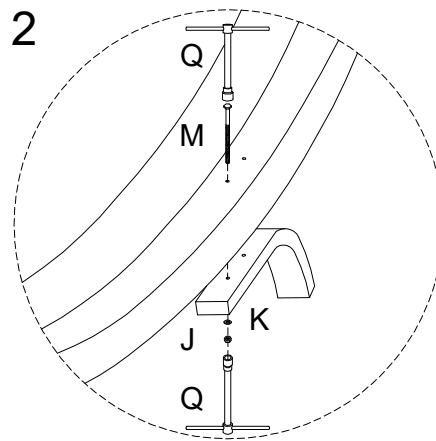
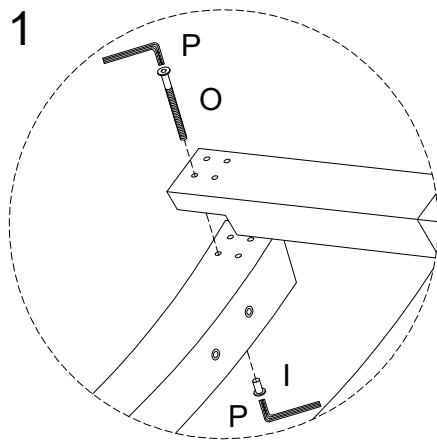
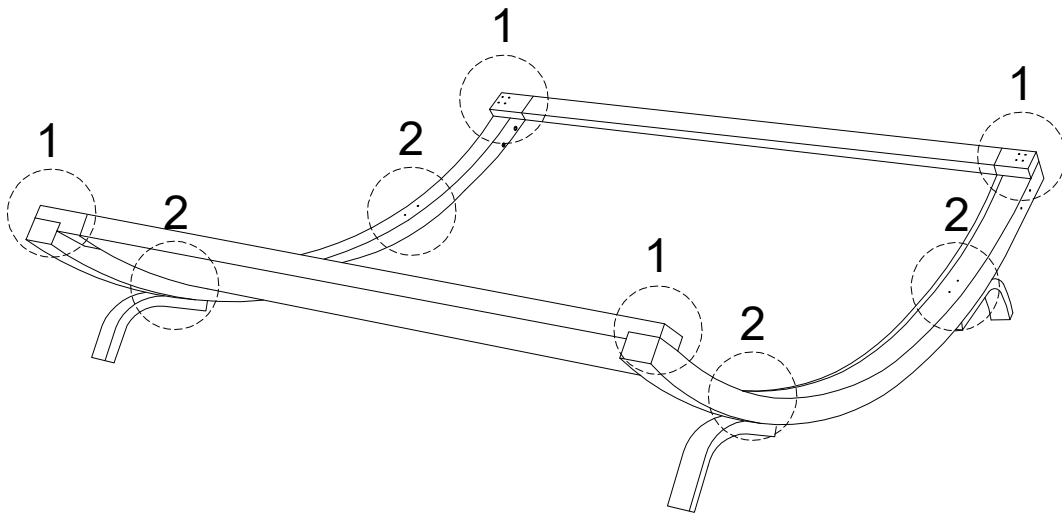

3

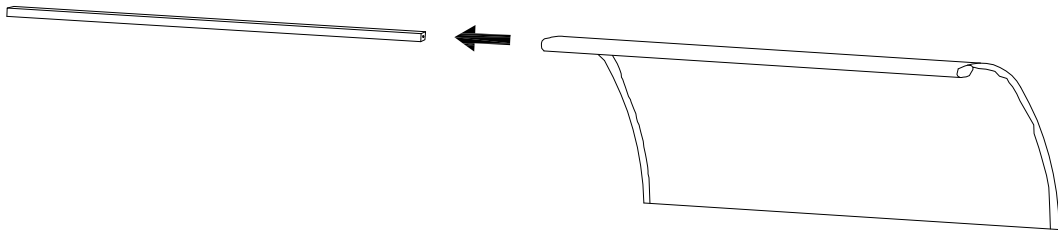
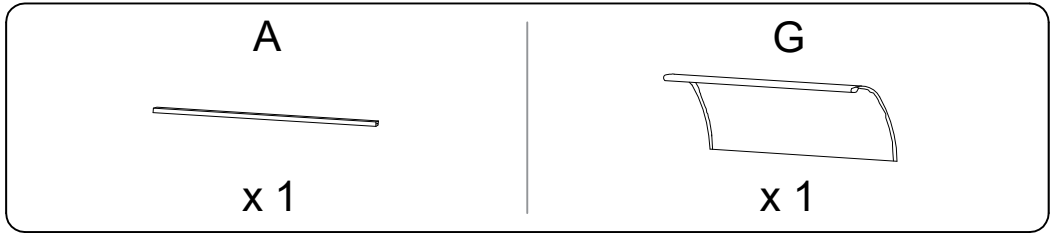

4

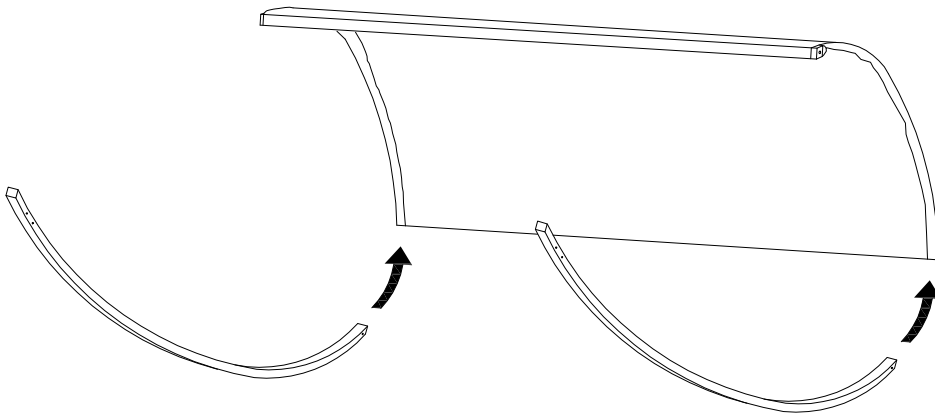
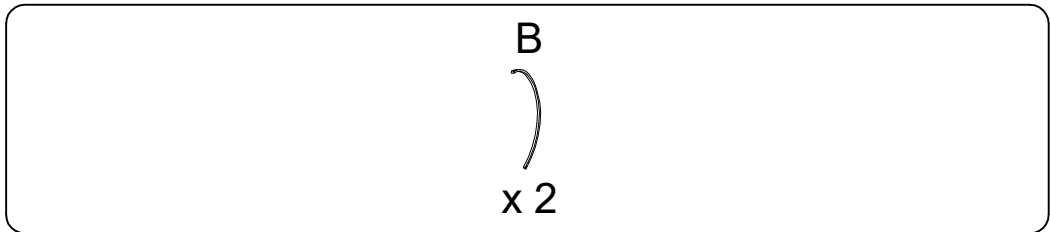

5

L
M8
x
50
x 2

P
x 1

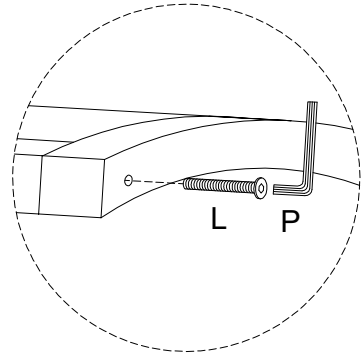
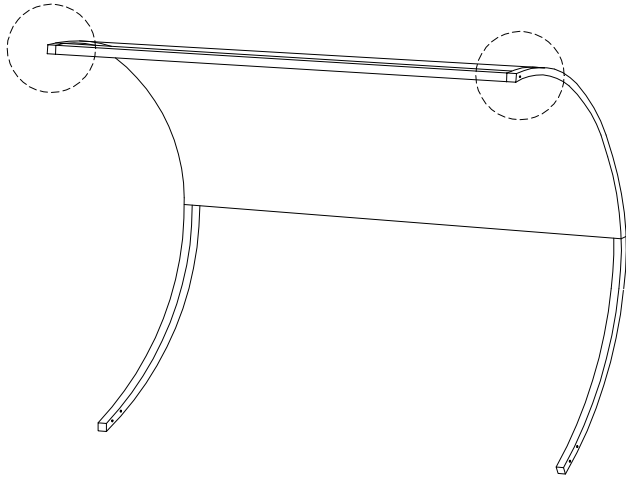

6

N
M8
x
100
x 4

I
x 4

P
x 2

