



<b>A</b>	<b>B</b>	<b>C</b>	<b>D</b>	<b>E</b>
				
<b>x 1</b>	<b>x 1</b>	<b>x 5</b>	<b>x 5</b>	<b>x 5</b>





**A**

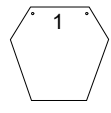
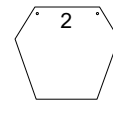
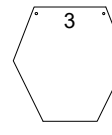
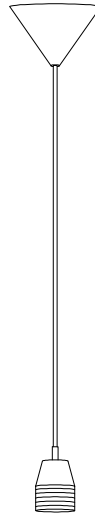

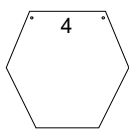
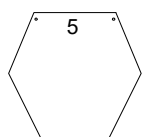
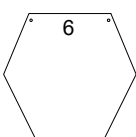
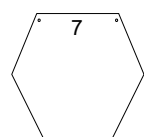
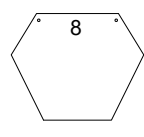
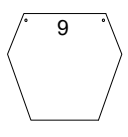
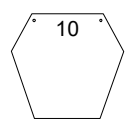
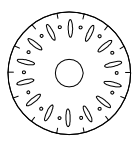
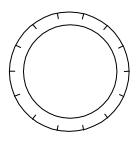
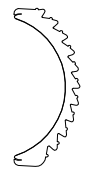
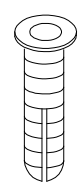
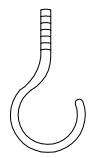
**B**

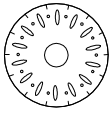
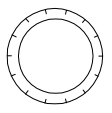

<b>F</b>	<b>G</b>	<b>H</b>	<b>I</b>	<b>J</b>	<b>K</b>
					
<b>x 5</b>	<b>x 5</b>	<b>x 5</b>	<b>x 5</b>	<b>x 5</b>	<b>x 5</b>
<b>L</b>	<b>M</b>	<b>N</b>	<b>O</b>	<b>P</b>	<b>Q</b>
					
<b>x 5</b>	<b>x 1</b>	<b>x 1</b>	<b>x 10</b>	<b>x 1</b>	<b>x 1</b>

1

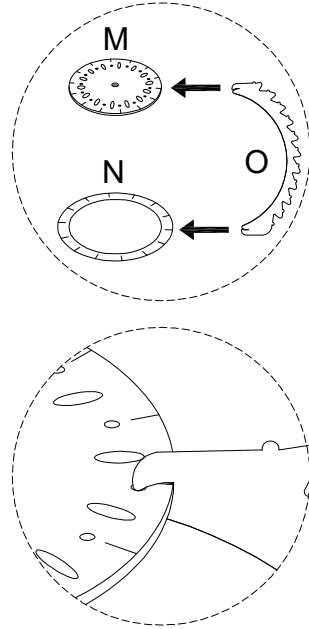
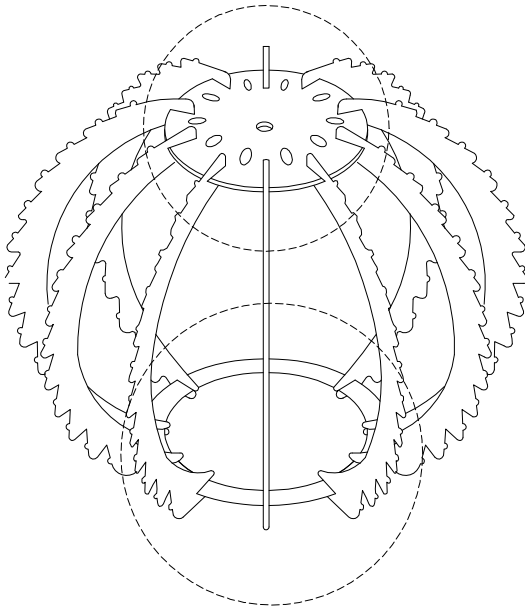
<b>M</b>  x 1	<b>N</b>  x 1	<b>O</b>  x 10
--	--	---

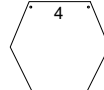
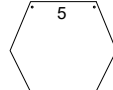
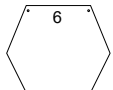
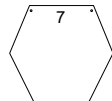
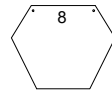
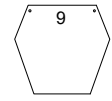
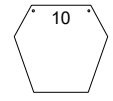

2

<b>C</b>  x 5	<b>D</b>  x 5	<b>E</b>  x 5	<b>F</b>  x 5	<b>G</b>  x 5
<b>H</b>  x 5	<b>I</b>  x 5	<b>J</b>  x 5	<b>K</b>  x 5	<b>L</b>  x 5

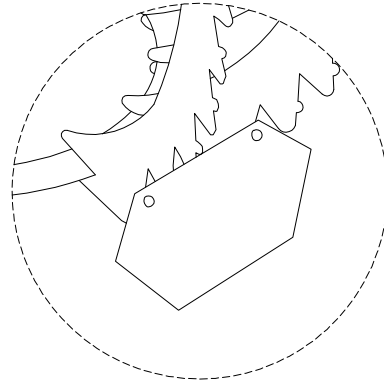
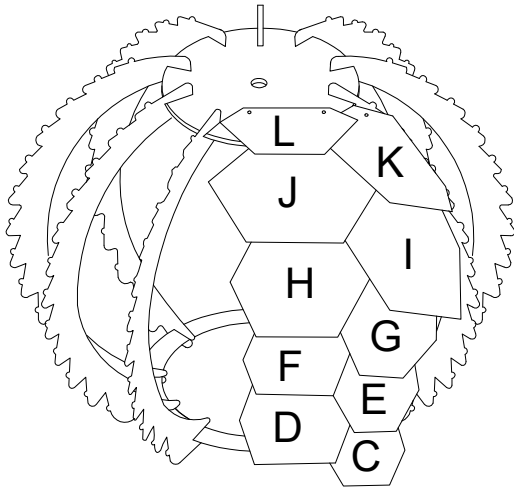

3

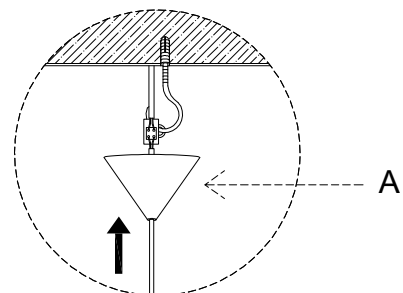
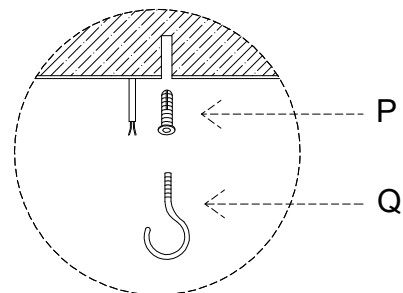
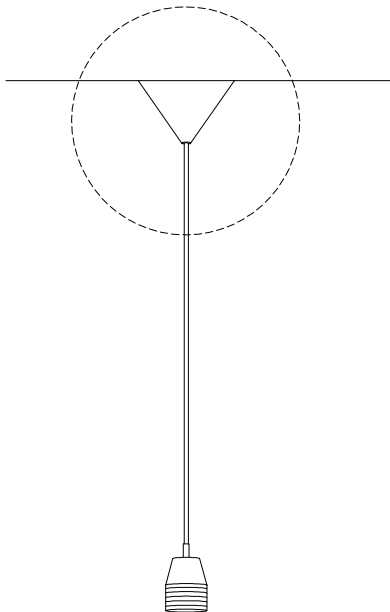
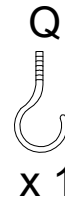
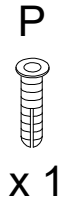

4

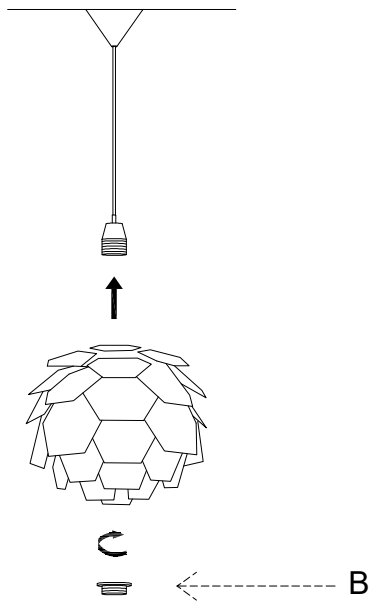
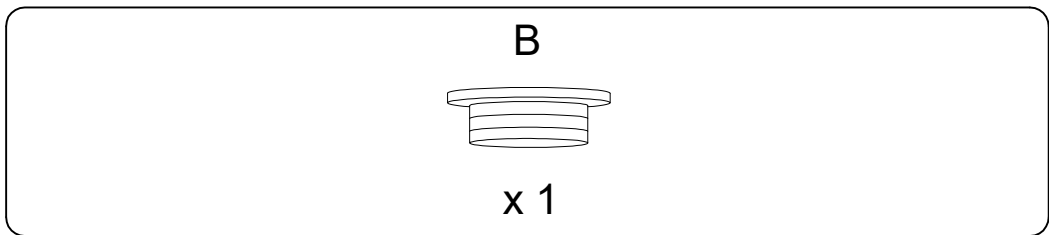

5

