

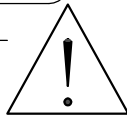

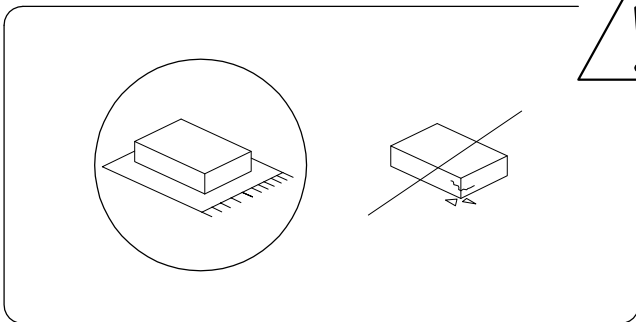

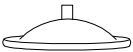



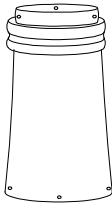
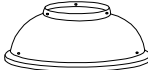
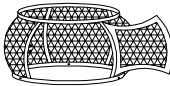

45'

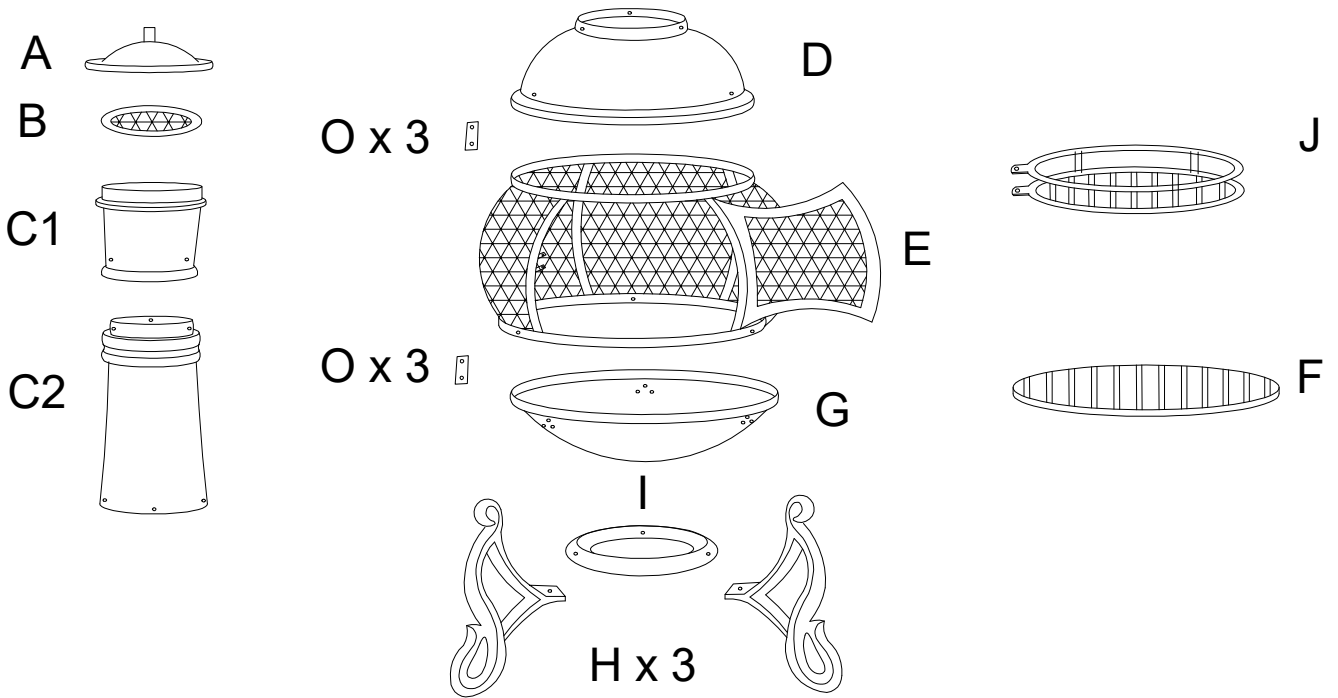



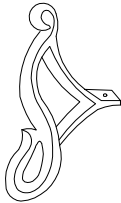
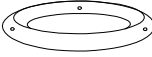
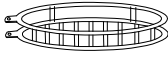

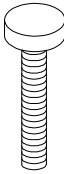
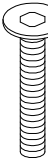
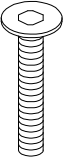
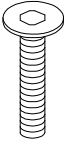
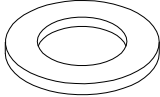
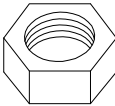
1

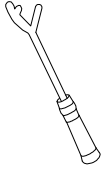
A	B	C1	C2	D	E	F
						
x 1	x 1	x 1	x 1	x 1	x 1	x 1



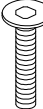
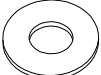

G	H	I	J	O	P	T1
						
x 1	x 3	x 1	x 1	x 6	x 1	M6 x 30 x 3
T2	T3	U	V	X	Y	Z
						
M6 x 25 x 9	M6 x 20 x 15	x 27	x 27	x 1	x 1	x 1

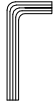
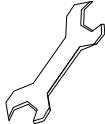
1

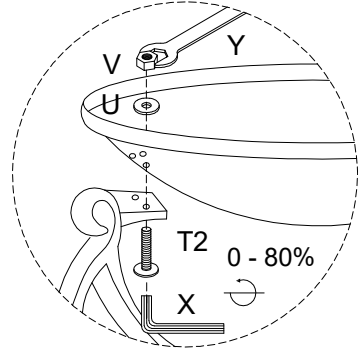
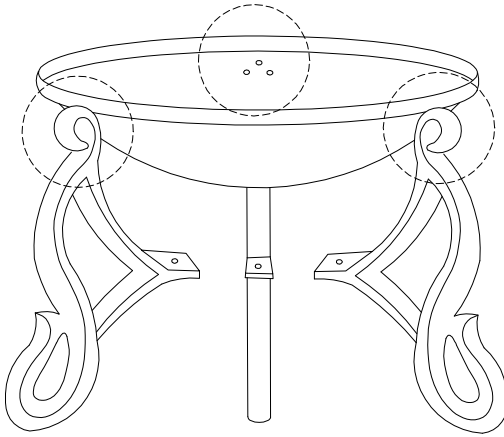
G  x 1	H  x 3	T2 M6 x 25  x 6	U  x 6	V  x 6	X  x 1	Y  x 1
--	--	--	--	---	--	--



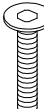

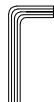
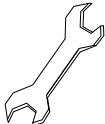

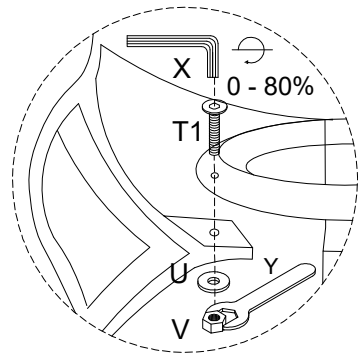
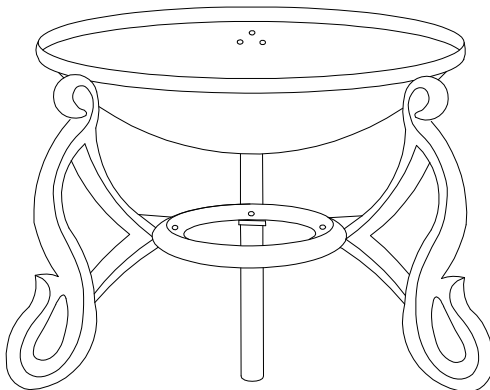
2

I  x 1	T1 M6 x 30  x 3	U  x 3	V  x 3	X  x 1	Y  x 1
--	--	--	---	--	--



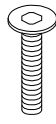
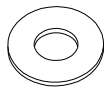

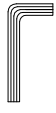
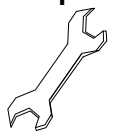

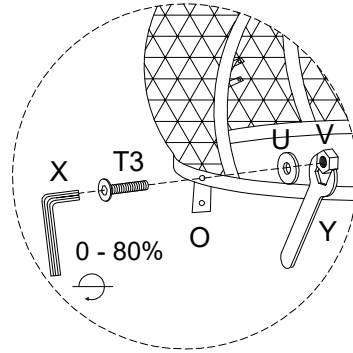
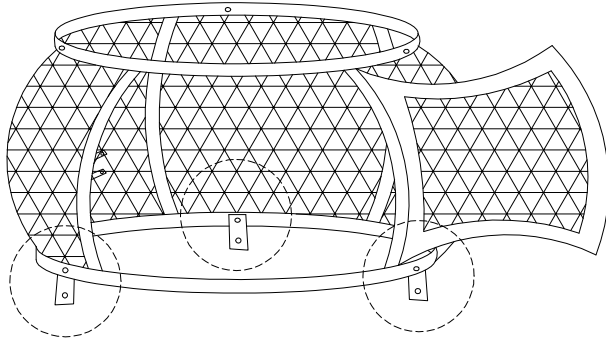
3

E  x 1	O  x 3	T3 M6 x 20  x 3	U  x 3	V  x 3	X  x 1	Y  x 1
--	--	--	--	---	--	--

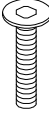

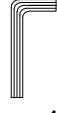

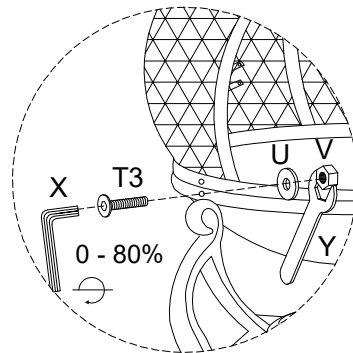
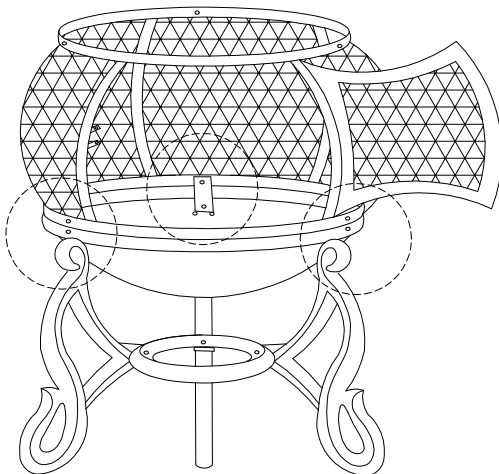

4

T3 M6 x 20  x 3	U  x 3	V  x 3	X  x 1	Y  x 1
--	--	--	--	--



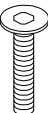

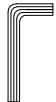
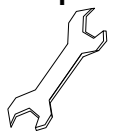
5

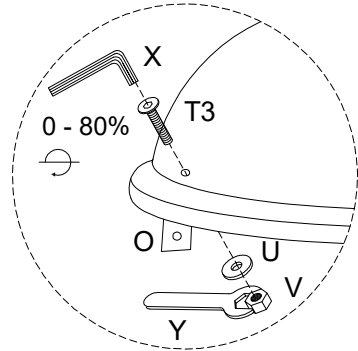
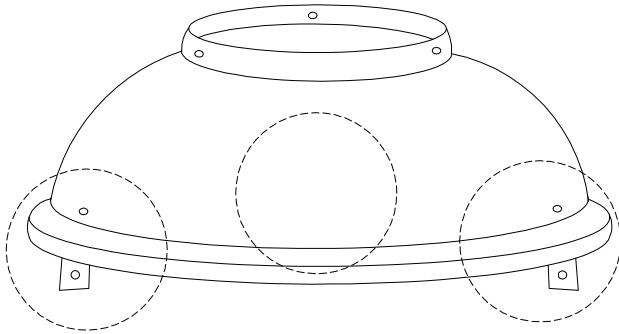
D  x 1	O  x 3	T3 M6 x 20  x 3	U  x 3	V  x 3	X  x 1	Y  x 1
--	--	---	--	---	--	--



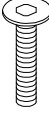

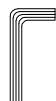
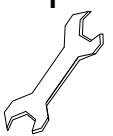

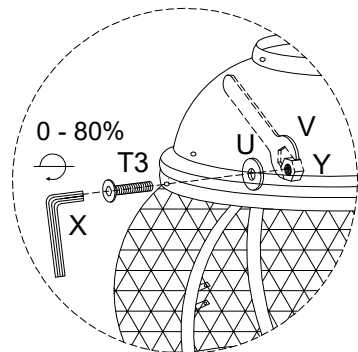
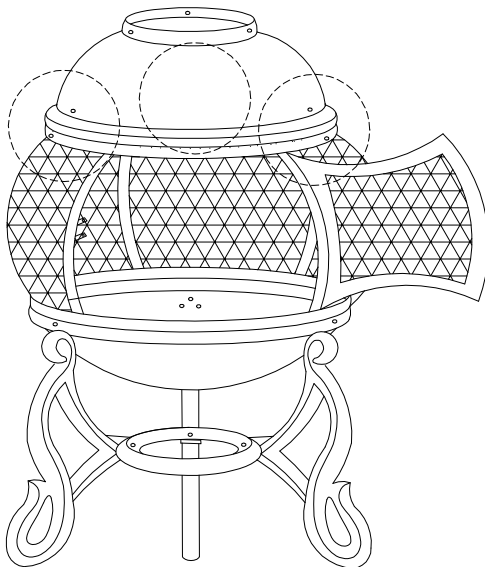

6

T3 M6 x 20  x 3	U  x 3	V  x 3	X  x 1	Y  x 1
---	--	--	--	--

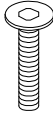



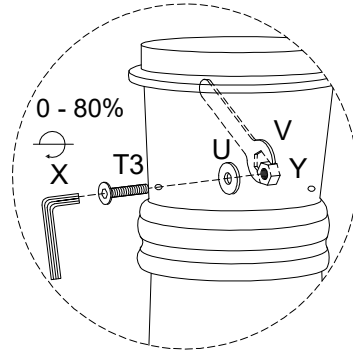
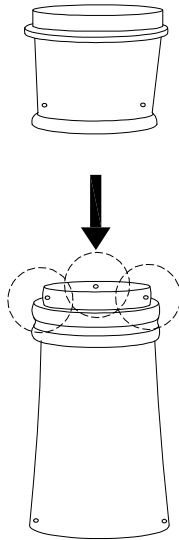

7

C1	C2	T3	U	V	X	Y
		 M6 x 20				
x 1	x 1	x 3	x 3	x 3	x 1	x 1

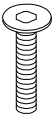

8

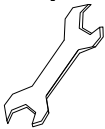
T2	U	V	X	Y
 M6 x 25				
x 3	x 3	x 3	x 1	x 1

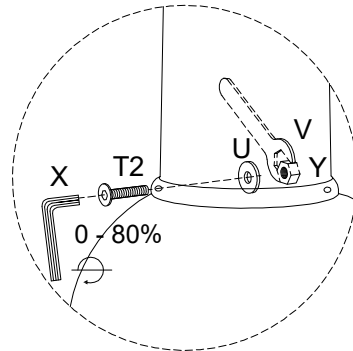
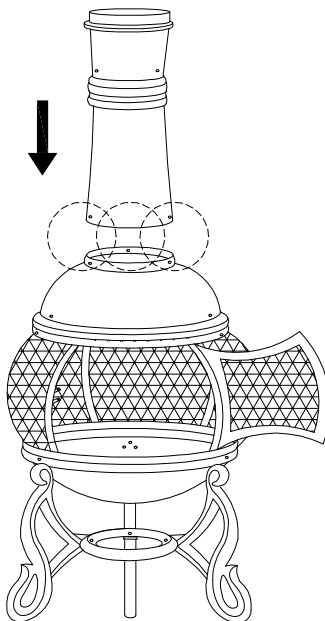

9

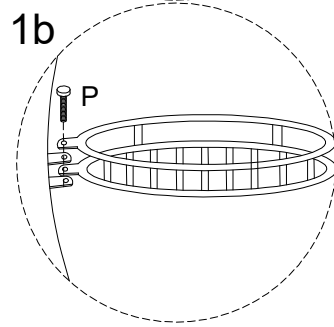
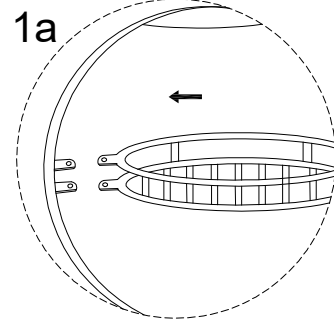
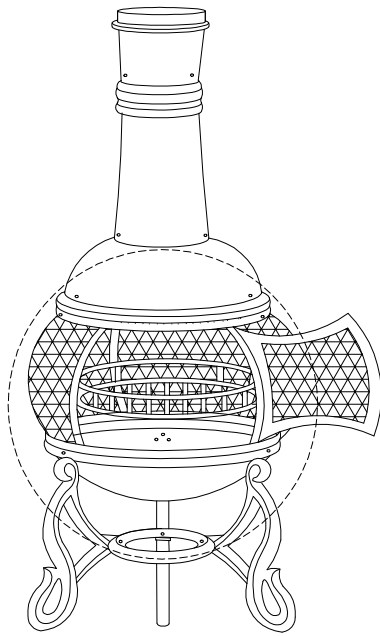
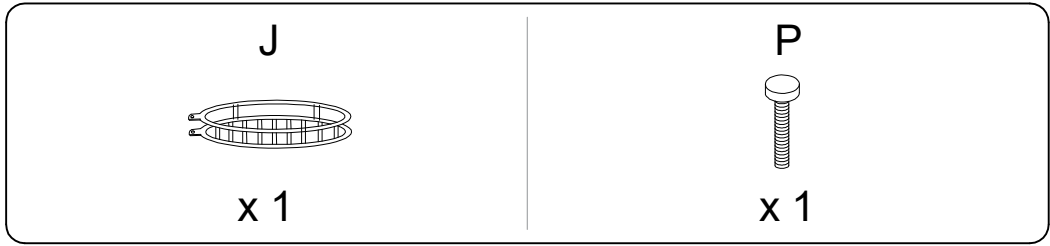

10

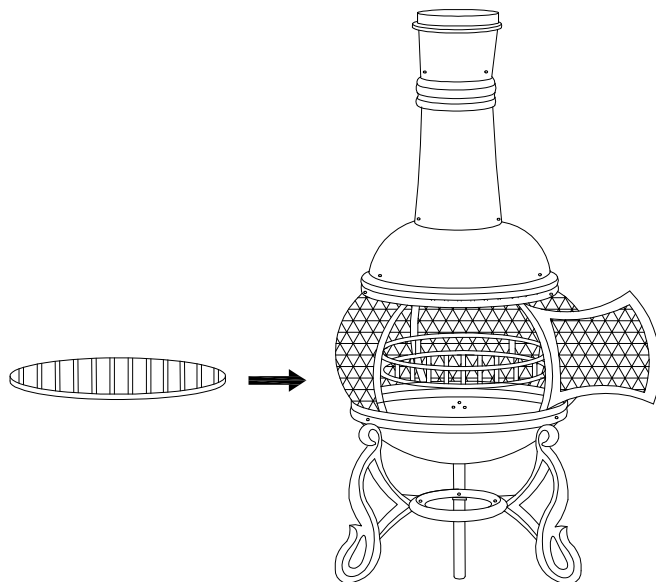
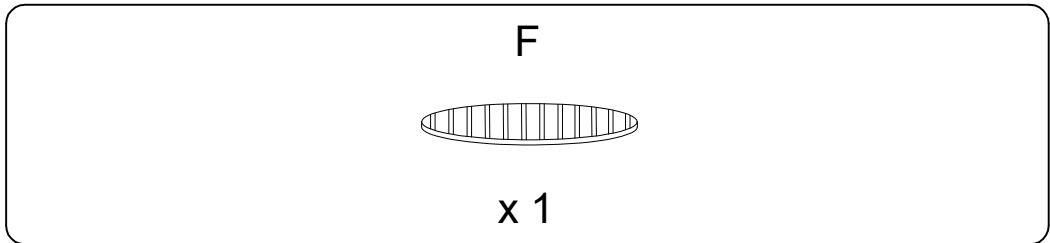

11

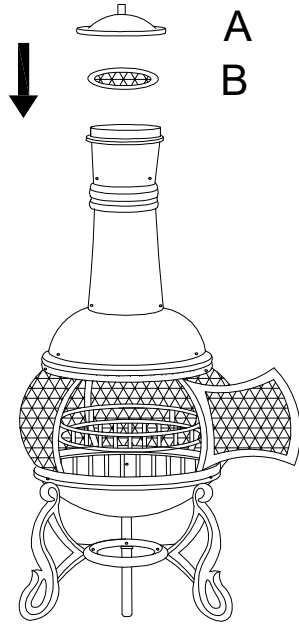
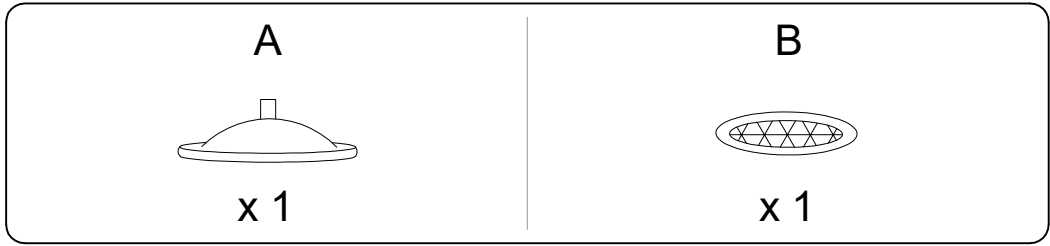

!

