

15'

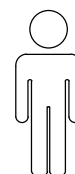
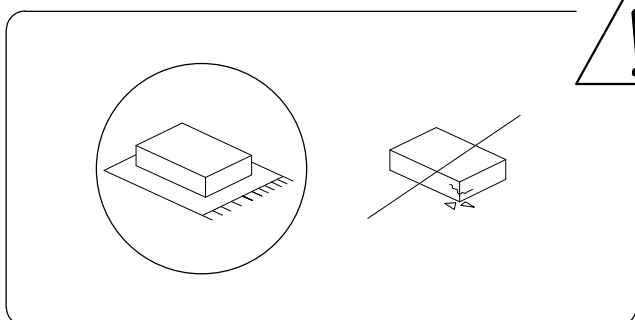

2

1/3

A

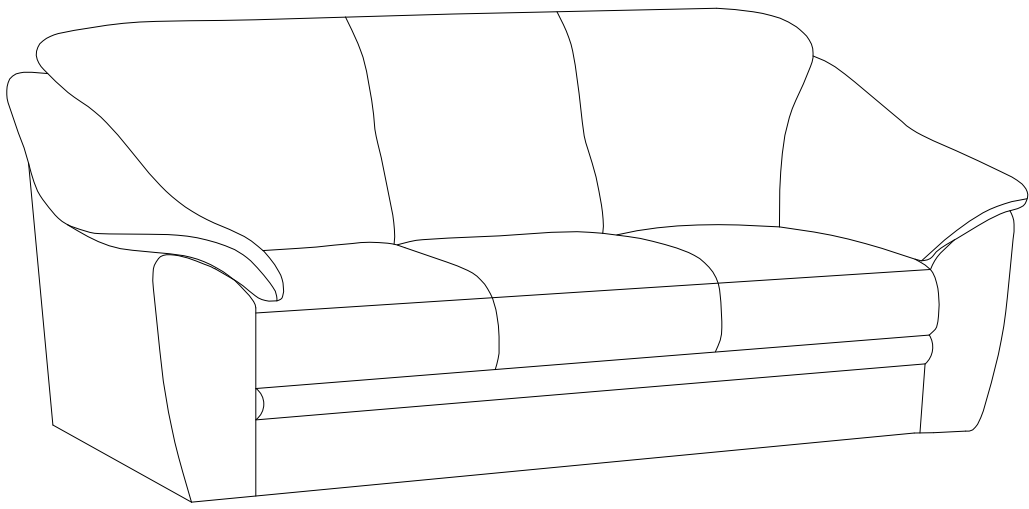

B x 4



A

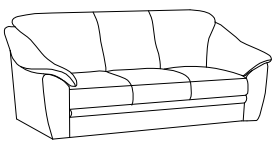

x 1

B

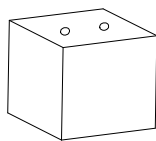

x 4

C

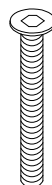

M6
x
60



x 8

D

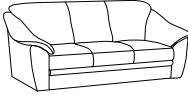
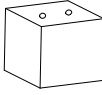
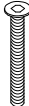

x 1

1

<p>A</p>  <p>x 1</p>	<p>B</p>  <p>x 4</p>	<p>C</p>  <p>M6 x 60</p> <p>x 8</p>	<p>D</p>  <p>x 1</p>
---	---	---	---

