

		<b>10'</b>
 		
		<b>1</b>

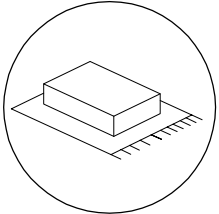

x 1

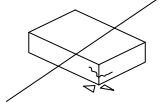
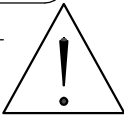
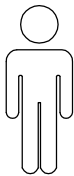
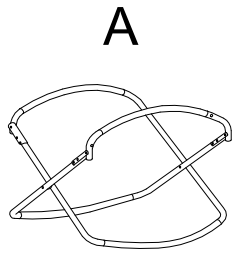
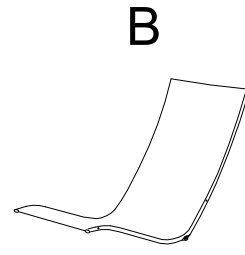
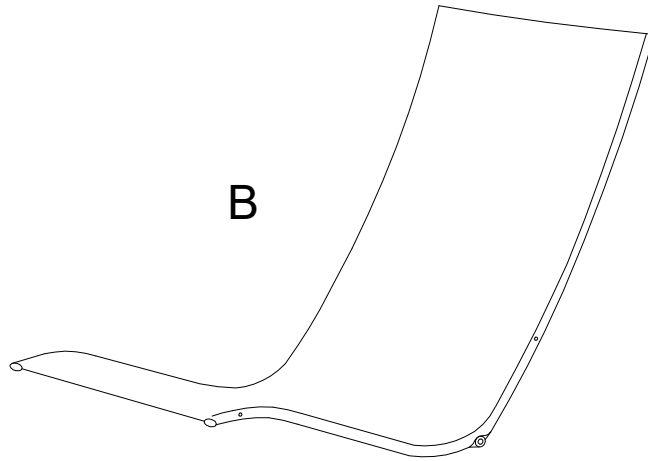

x 1



B

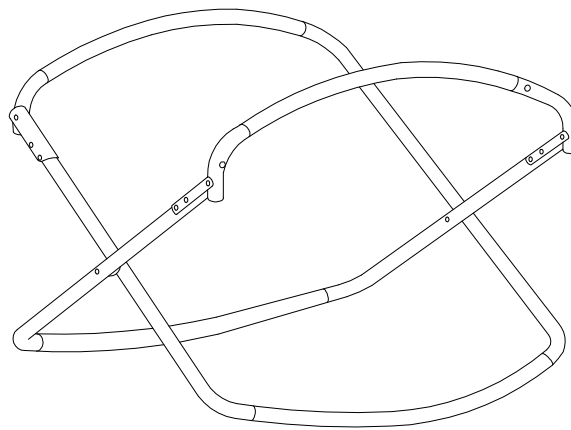

A

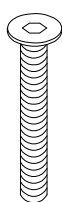

M6  
x  
45

x 4

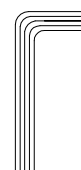

x 1

1

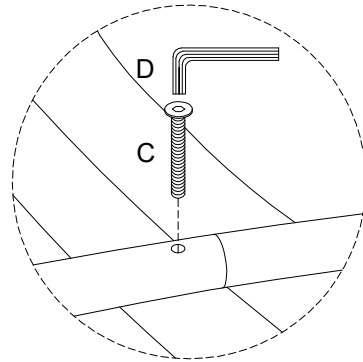
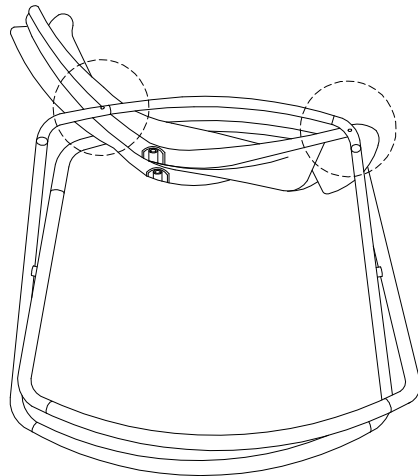
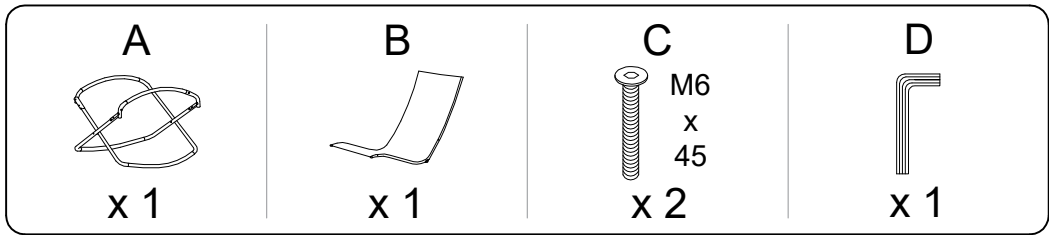

2

