



1/5



A	B	C	D	E
				
x 1	x 1	x 5	x 5	x 5

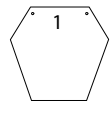
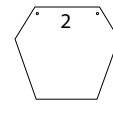
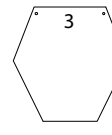
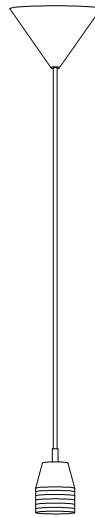

A

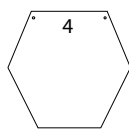
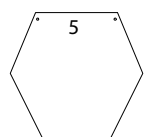
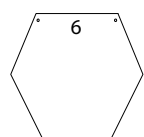
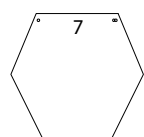
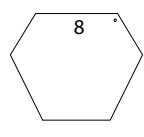
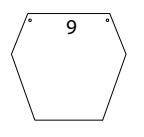
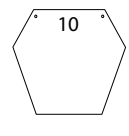
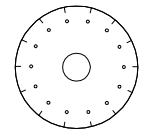
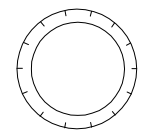

B

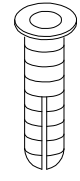
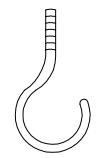
F	G	H	I	J	K
					
x 5	x 5	x 5	x 5	x 5	x 5
L	M	N	O	P	Q
					
x 5	x 1	x 1	x 10	x 1	x 1



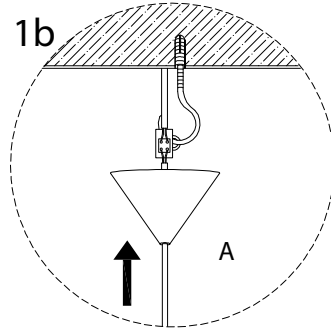
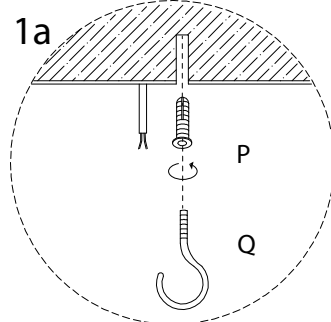
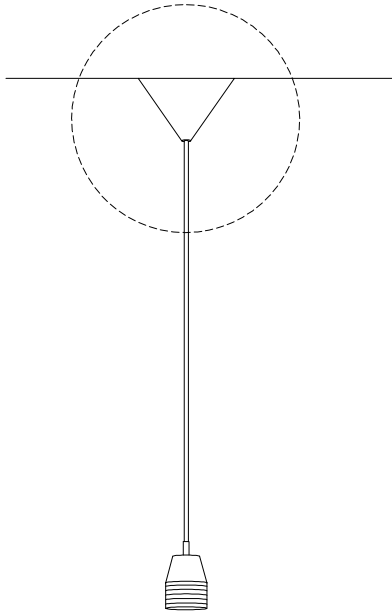
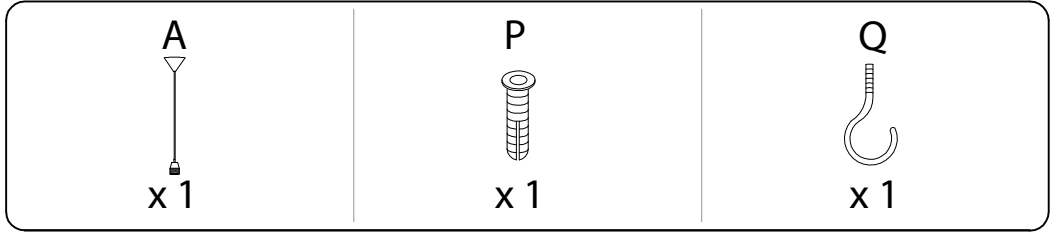

1

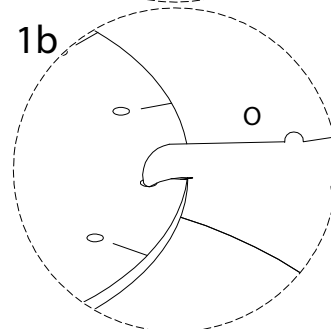
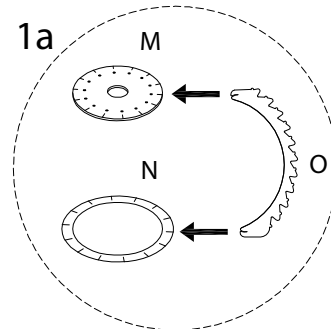
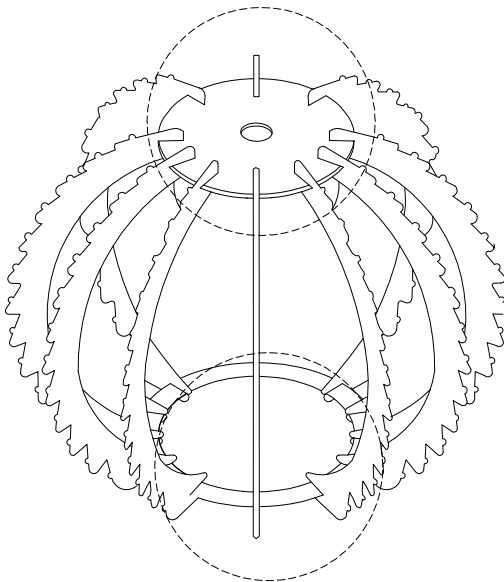
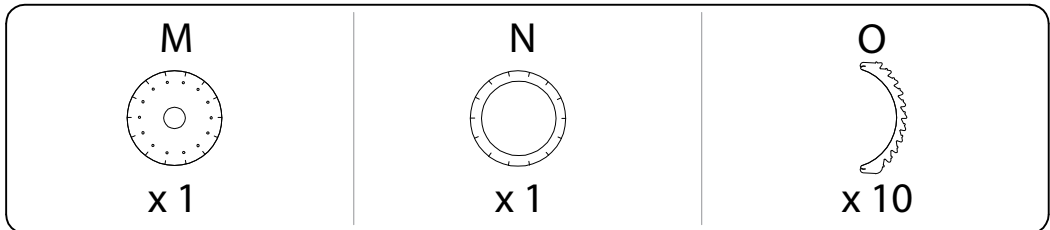

2

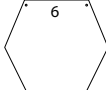
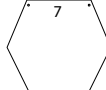
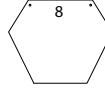
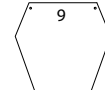
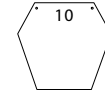

3

C  x5	D  x5	E  x5	F  x5	G  x5
H  x5	I  x5	J  x5	K  x5	L  x5

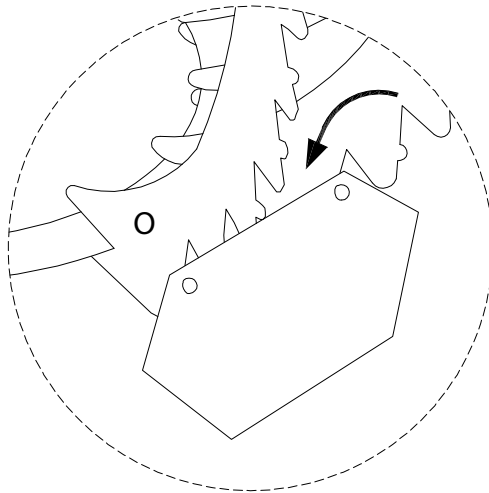
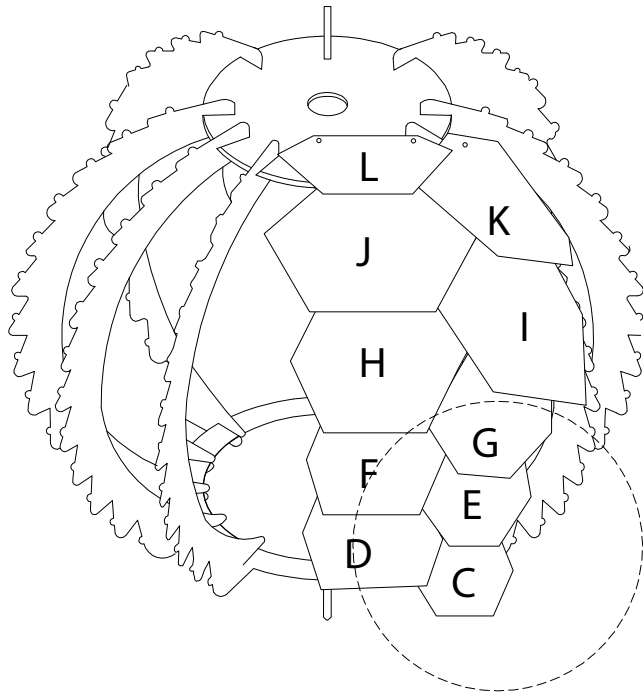

4

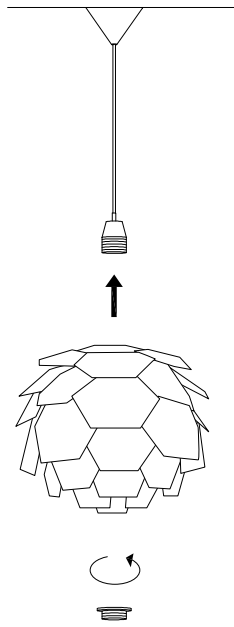
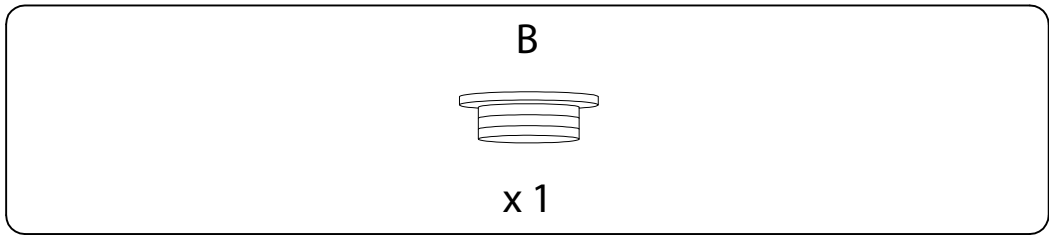

5

