

60'

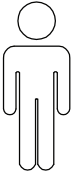

2

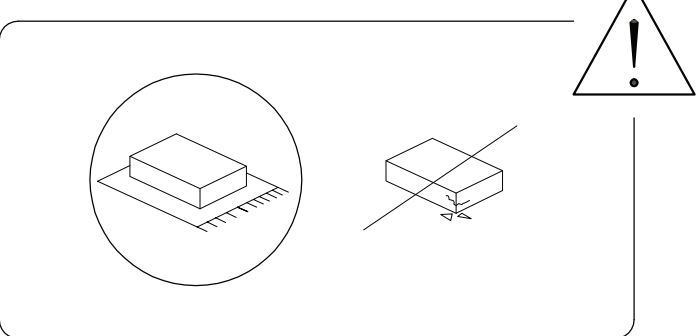
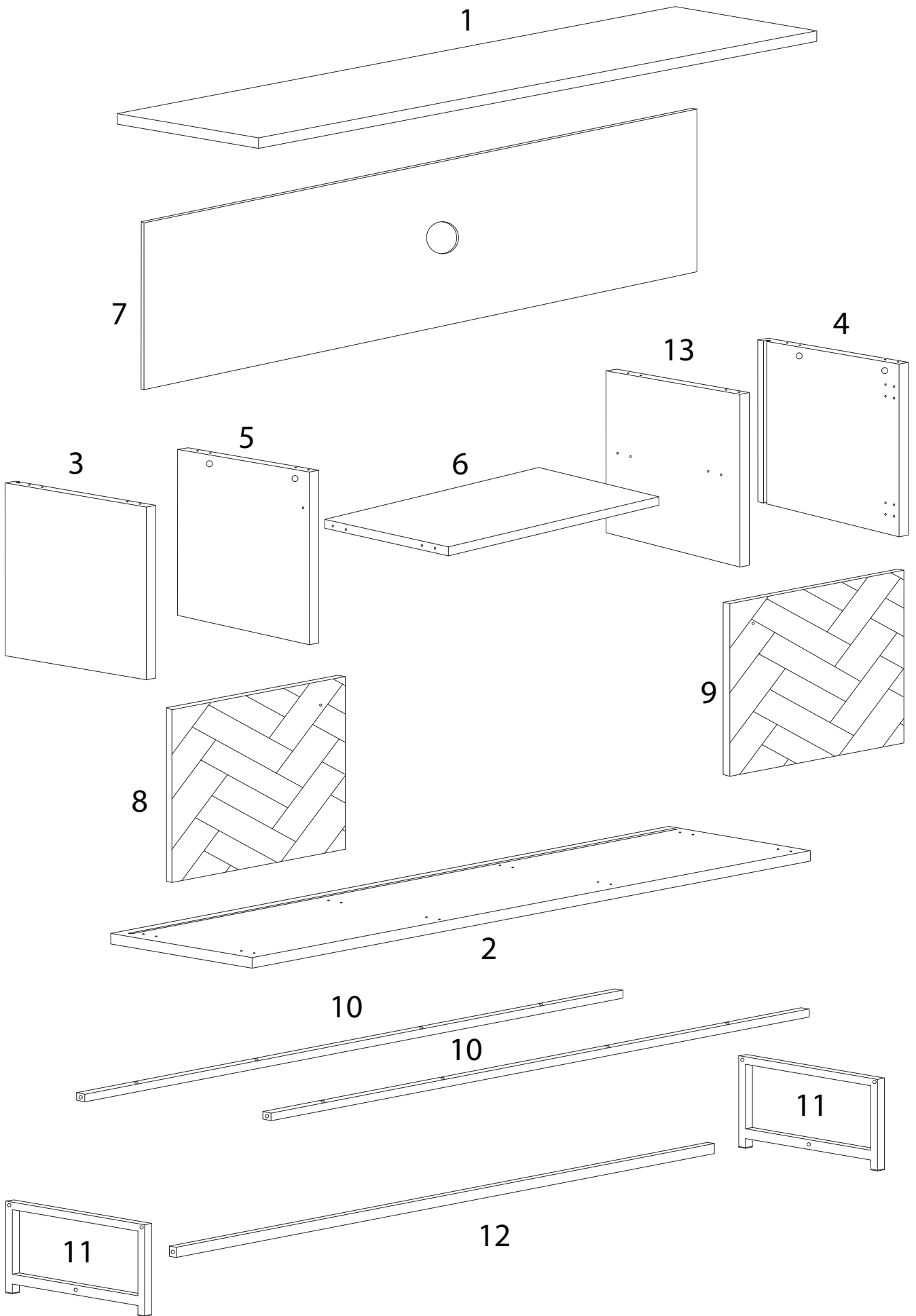

1

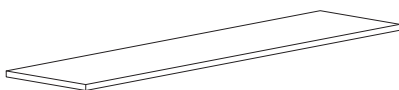

x 1

2

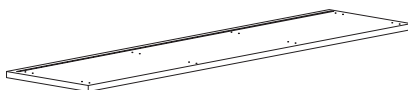

x 1

3

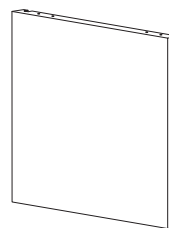

x 1

4

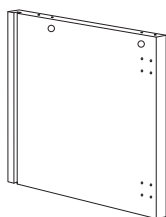

x 1

5

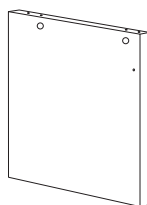

x 1

6

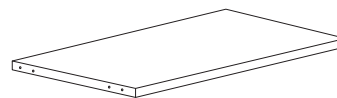

x 1

7

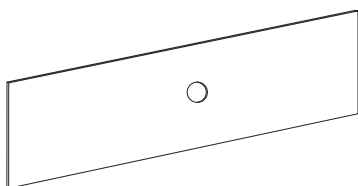

x 1

8

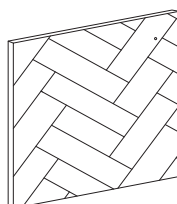

x 1

9

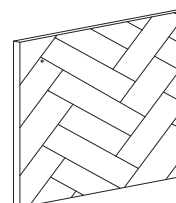

x 1

10



x 2

11

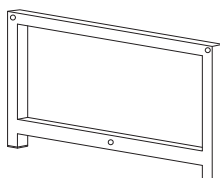

x 2

12

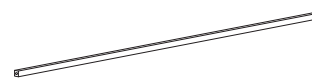

x 1

13

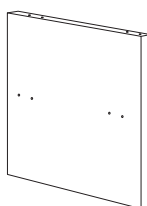

x 1

A



x 12

B

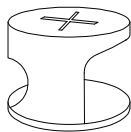

x 12

C

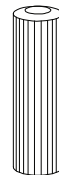

x 20

D

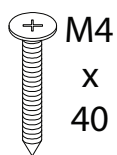

x 8

G



x 2

I

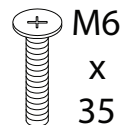

x 6

J

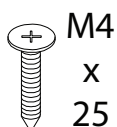

x 10

K

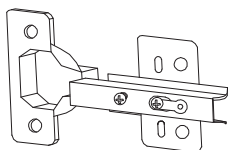

x 4

L

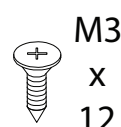

x 24

N

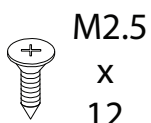

x 10

O

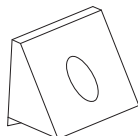

x 10

P1



x 2

P2

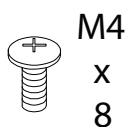

x 2

P3



x 2

1

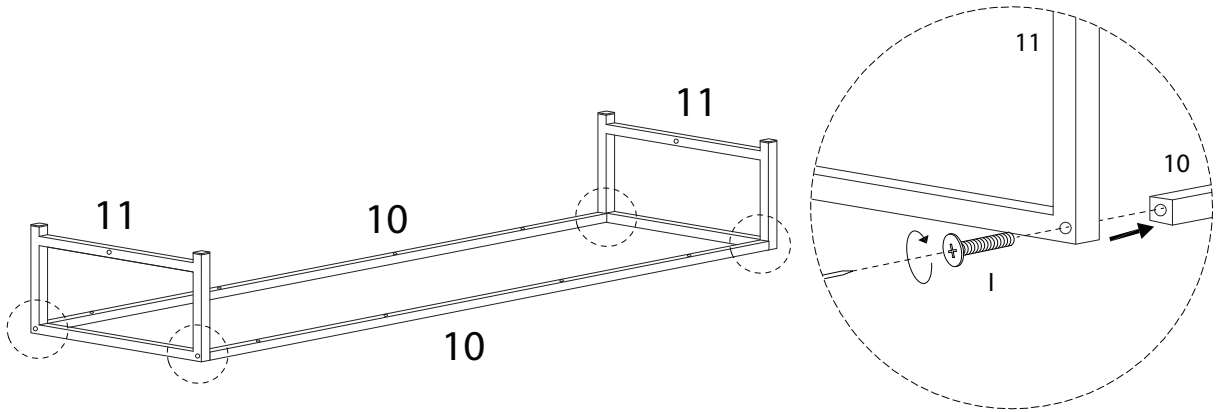
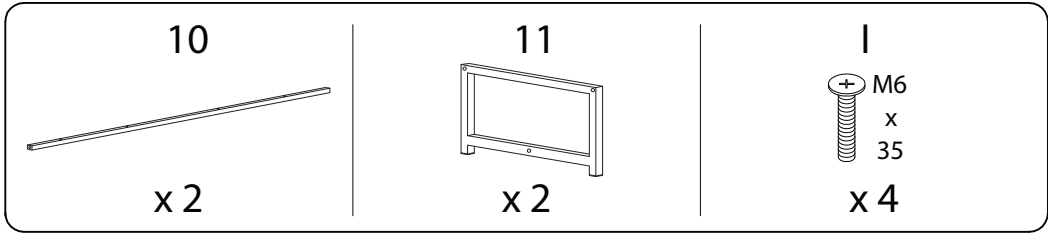

2

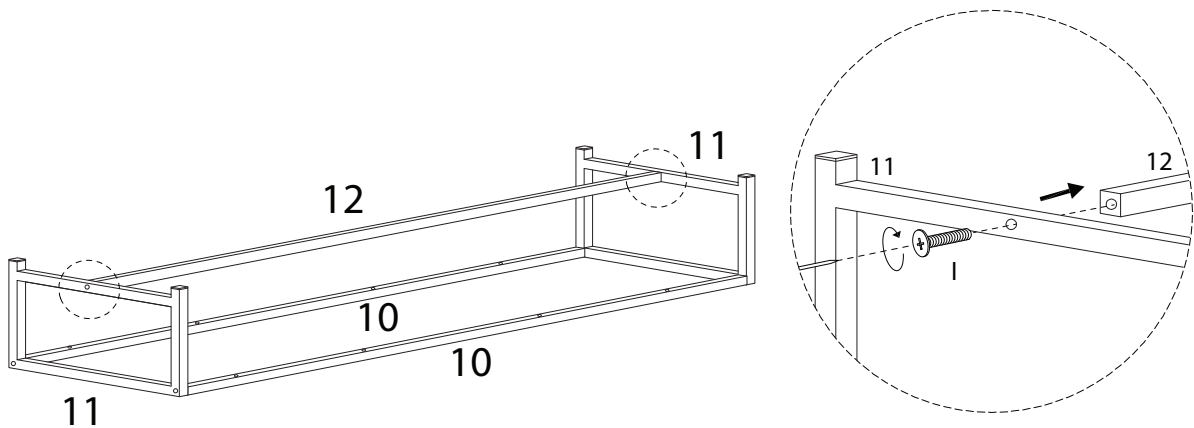
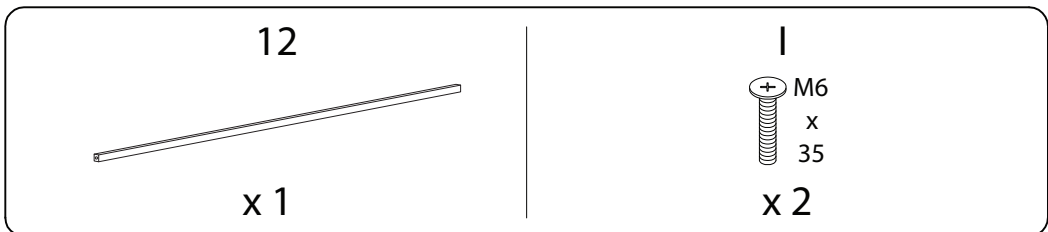

3

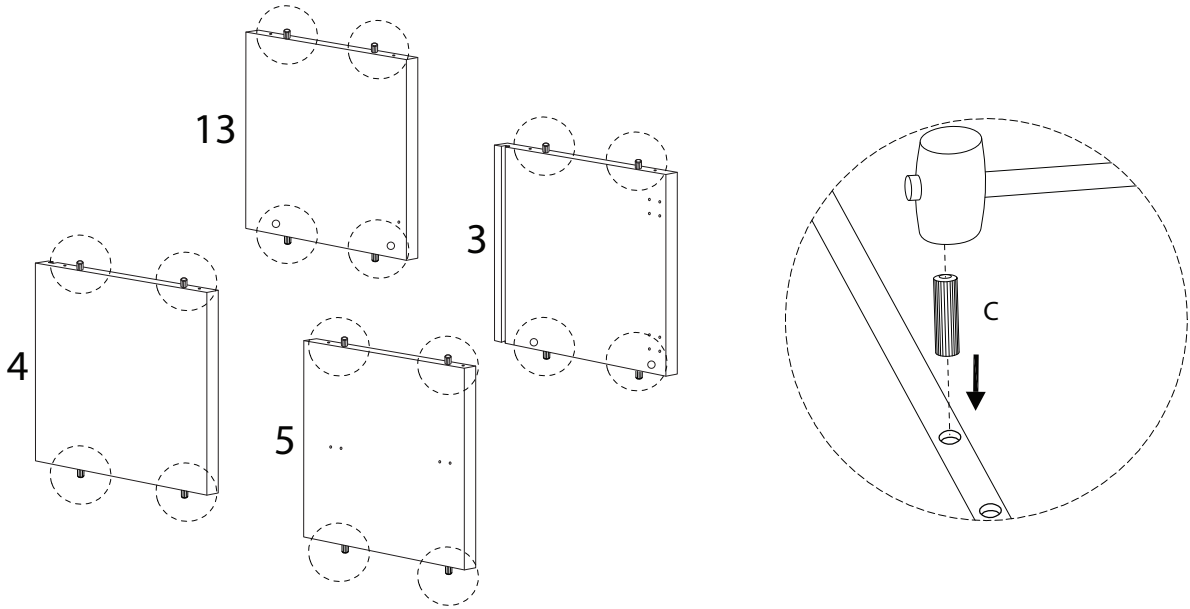
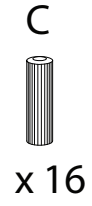
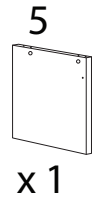
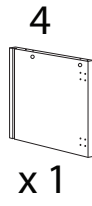
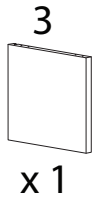

4

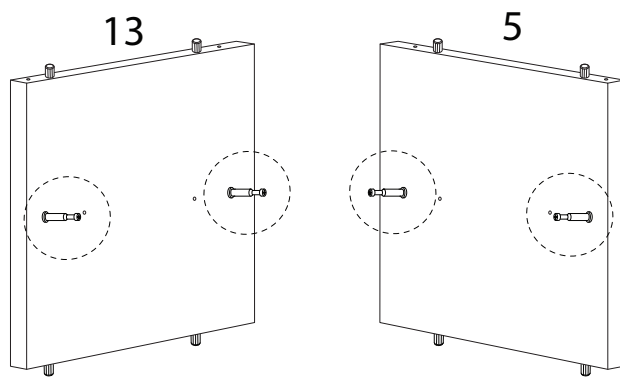
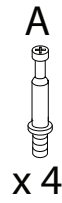

5

G

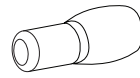

x2

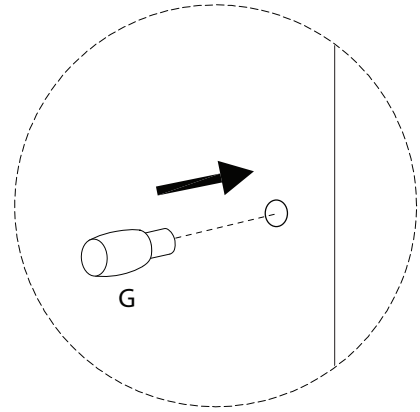
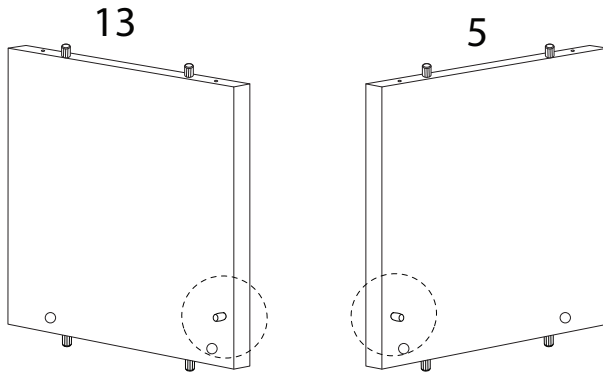

6

6

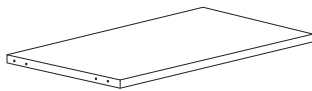

x1

C



x4

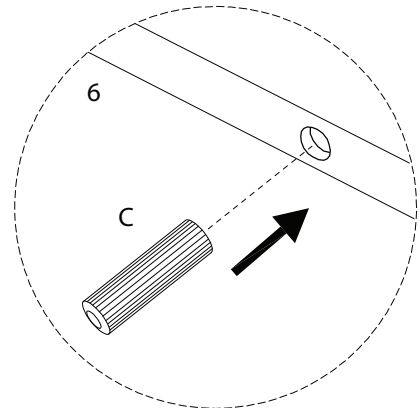
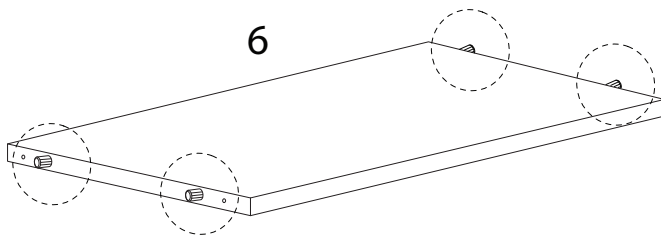

7

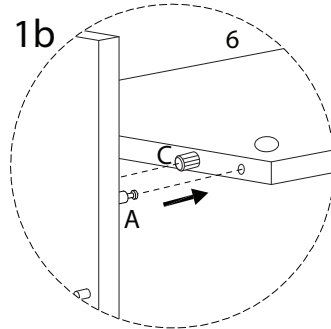
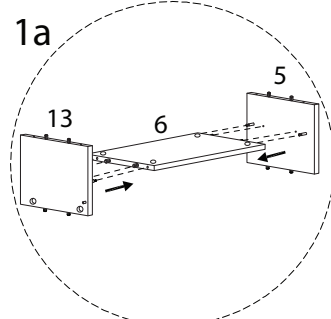
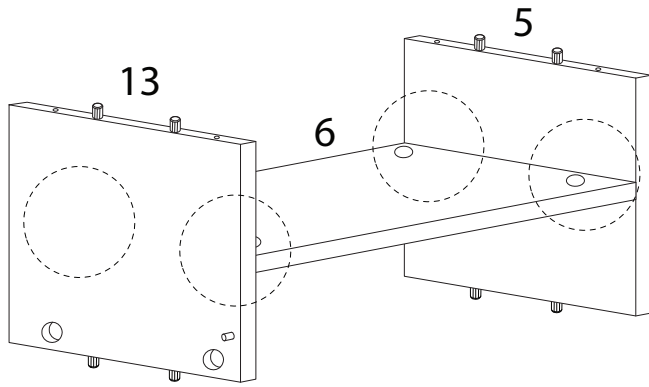

8

B



x 4

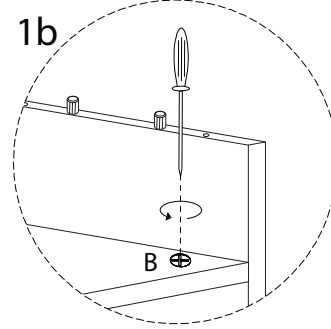
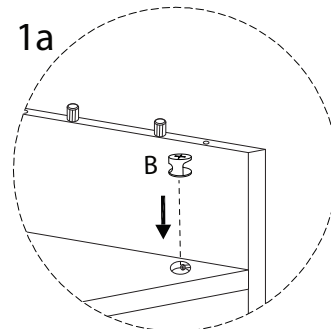
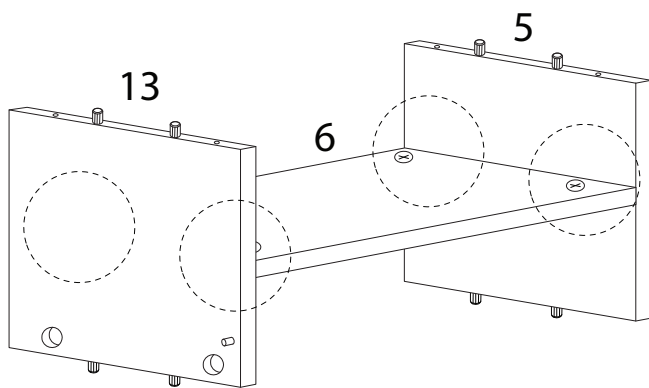

9

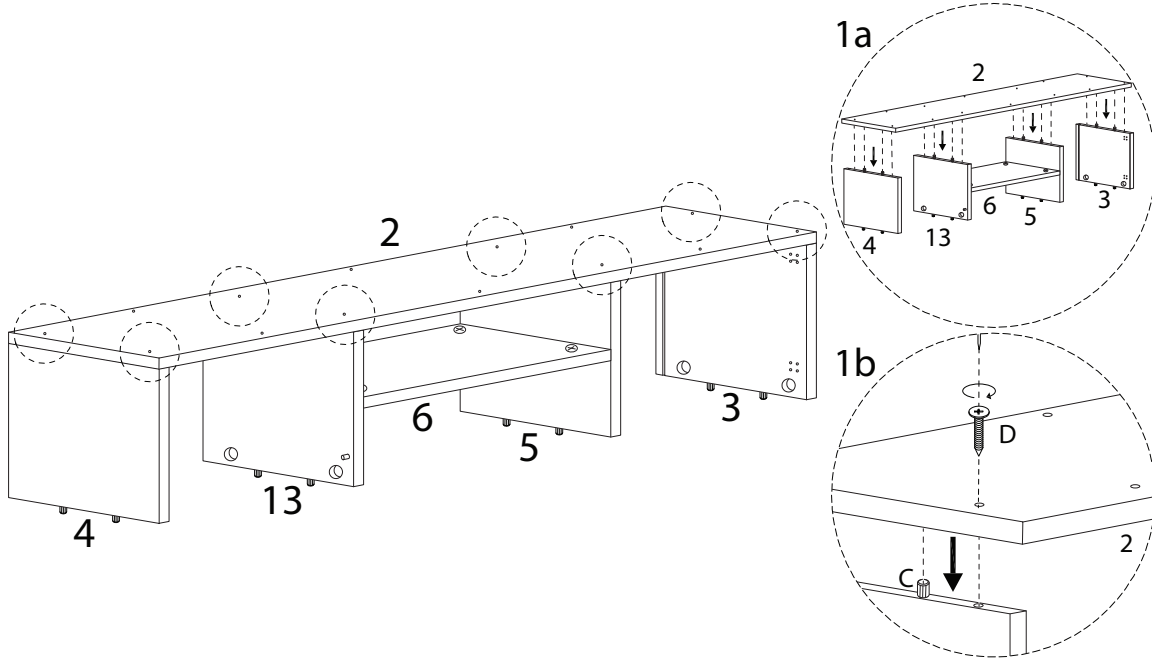
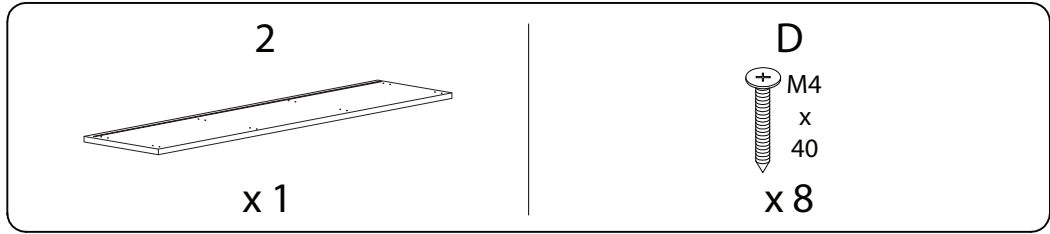

10

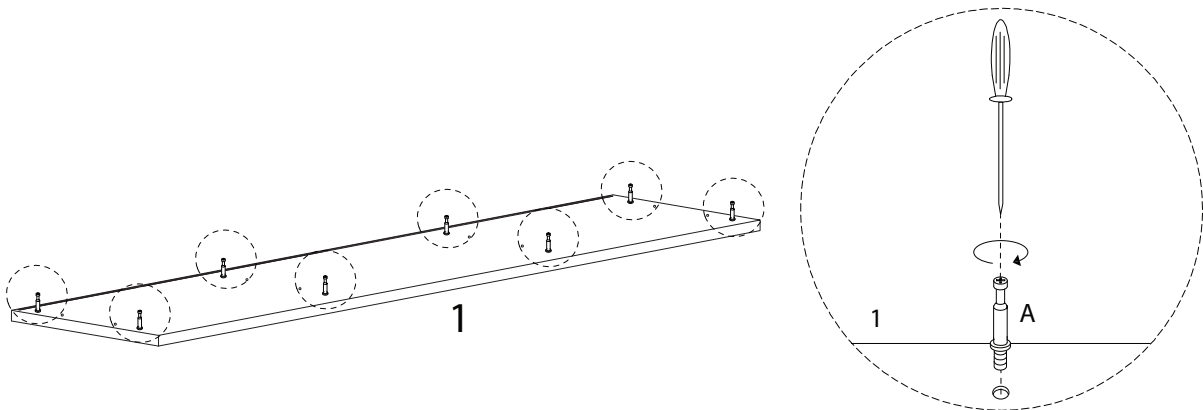
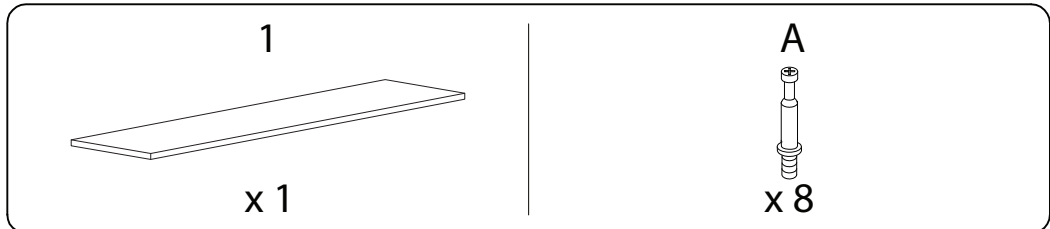

11

J



x 10

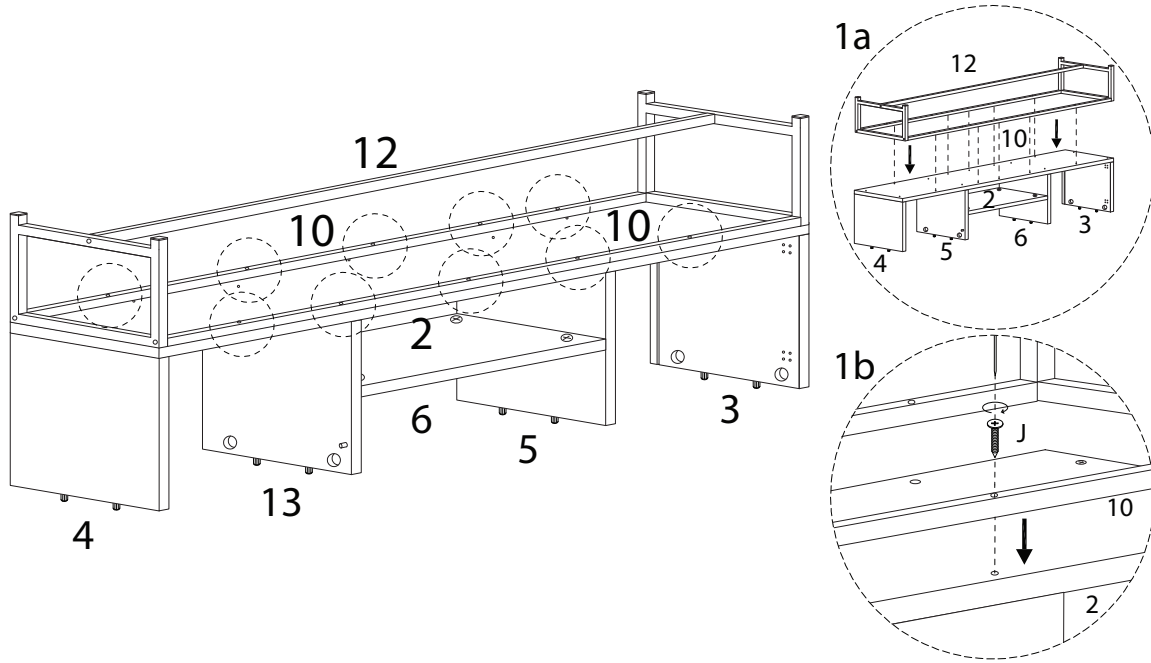

12

7

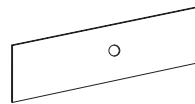

x 1

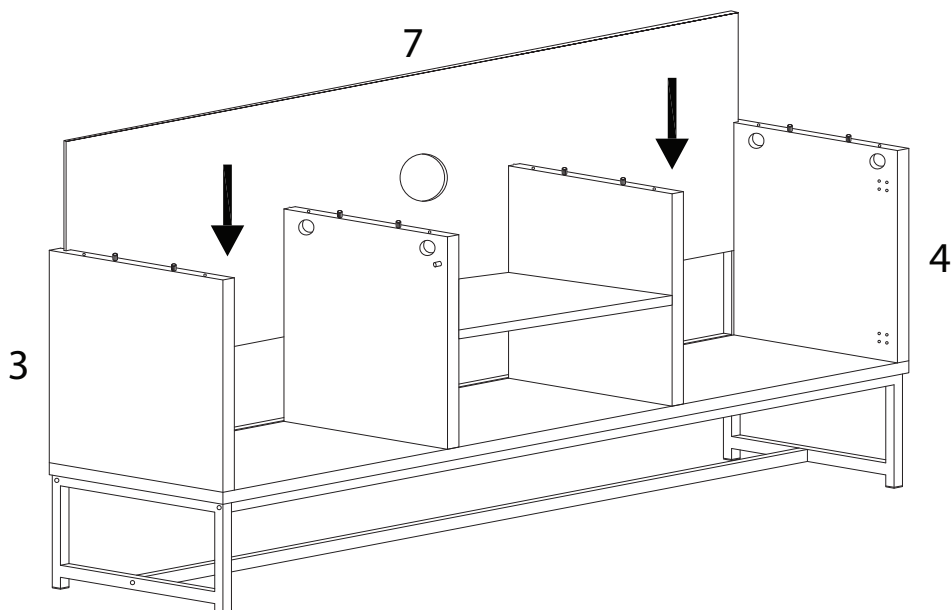

13

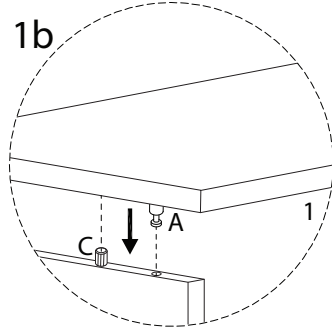
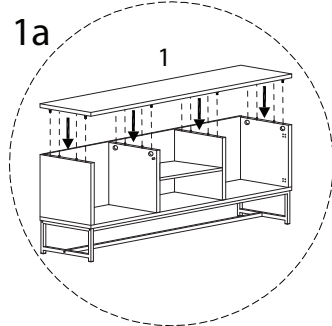
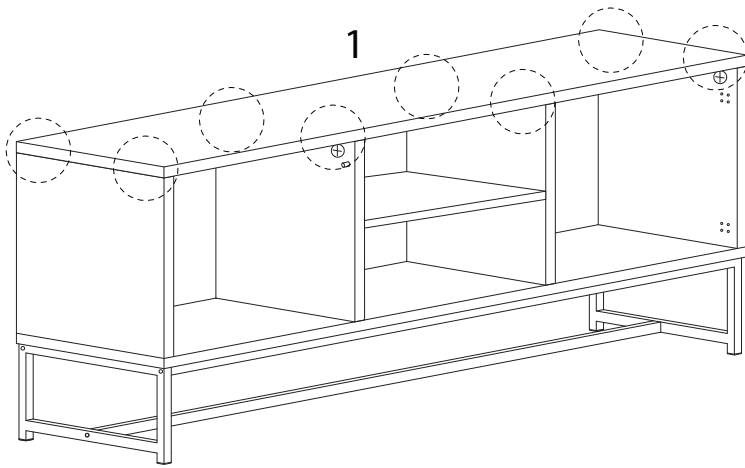

14

B



x 8

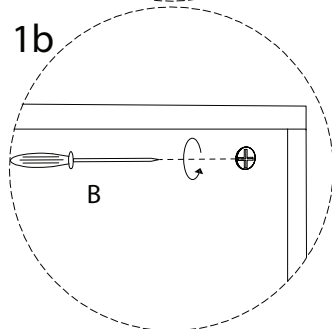
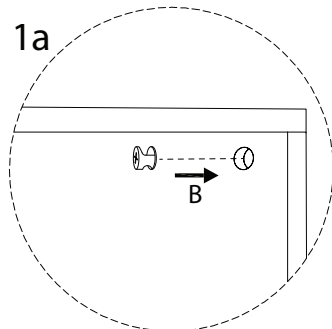
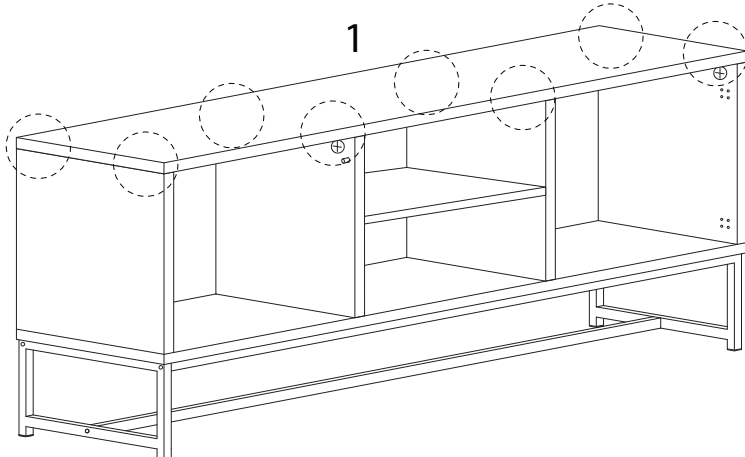

15

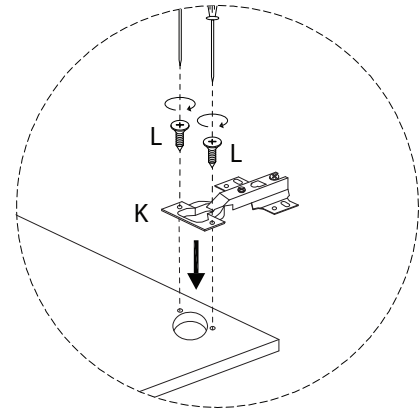
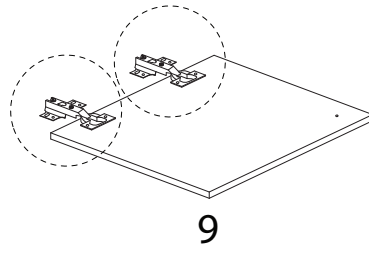
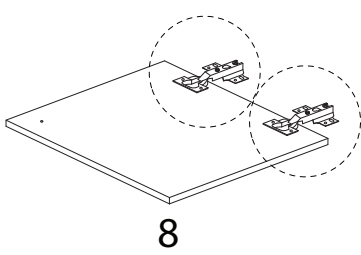
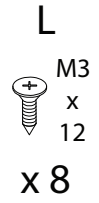
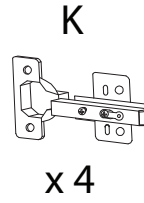
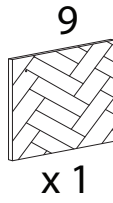
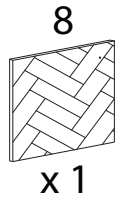

16

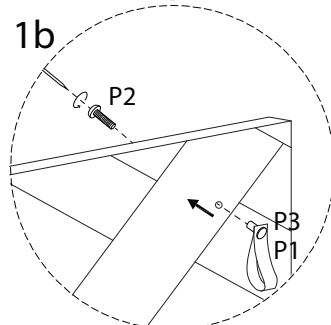
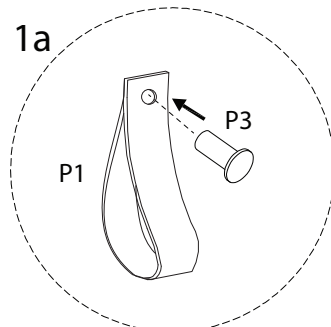
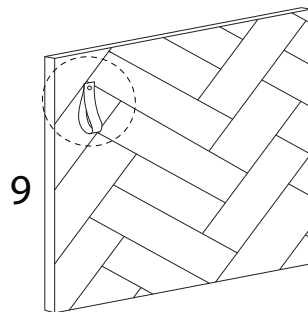
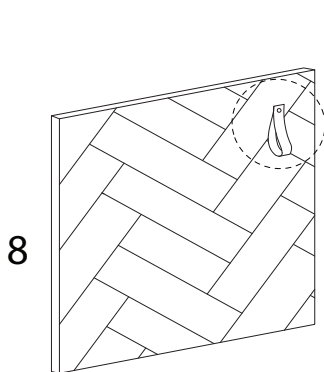
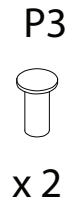
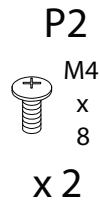

17

N

M2.5
x
12
x 10

O



x 10

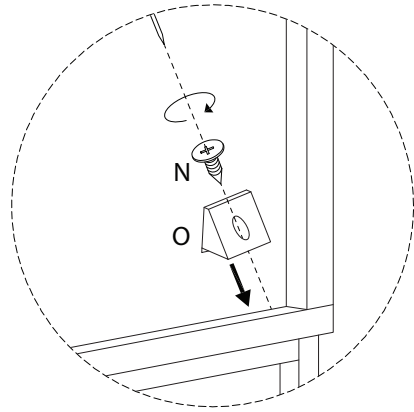
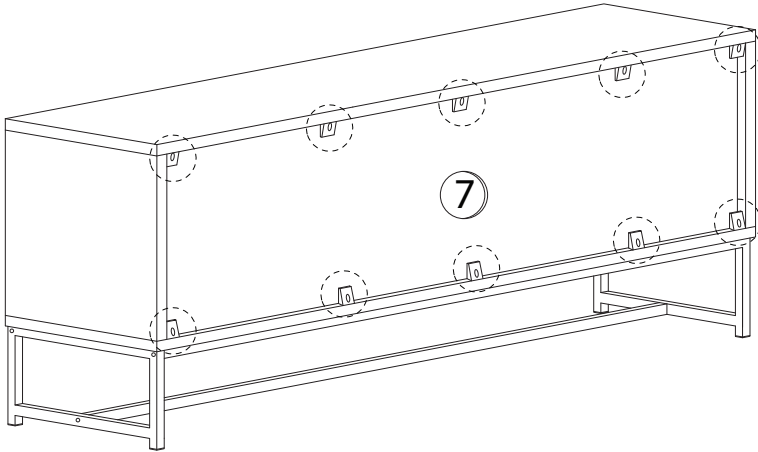

18

L

M3
x
12
x 16

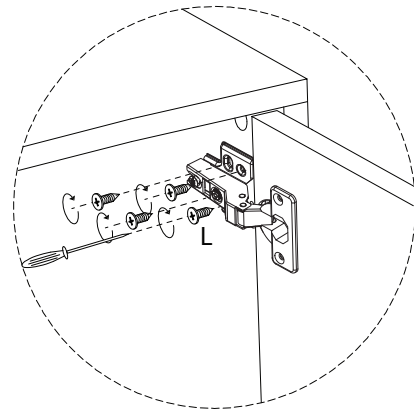
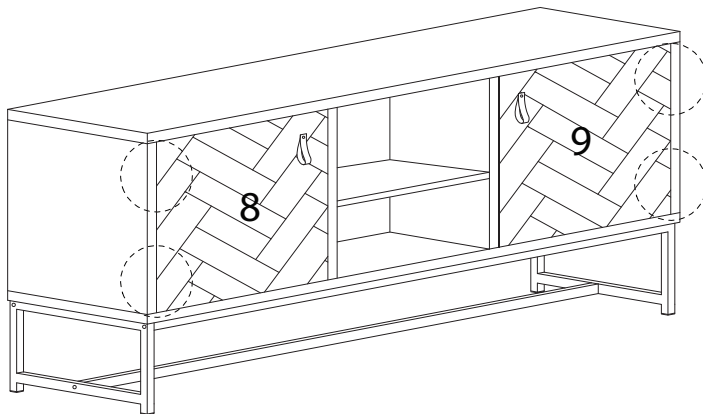

19

