

**MODEL: A-20P**

**USE INSTRUCTION HANDBOOK**

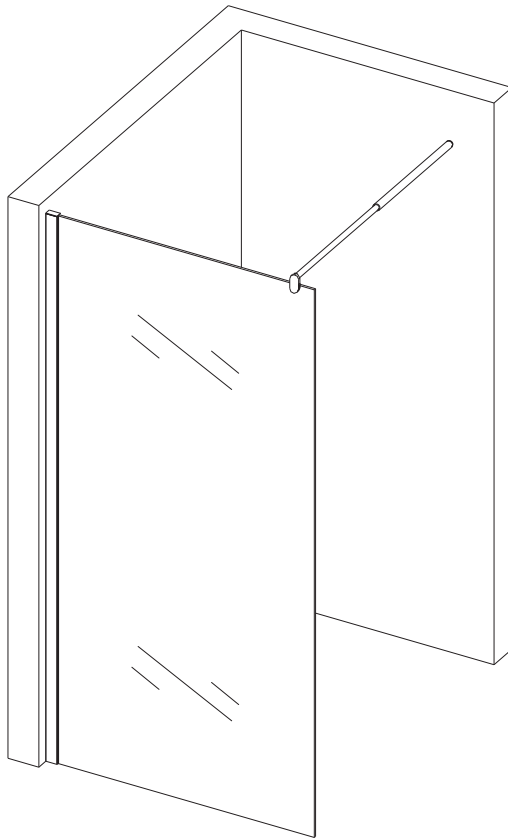

**Instruction:**

Adjusting would be made as follows when the sliding door is un-adsorption or loose:

- (1) used the Phillips screwdriver to adjusting the vertical screws of the roof wheels, adjusting the sliding glass up or down, to make it in a suitable place.
- (2) After installation, sealed the frame and tray basin gap place with silica gel. Then, use the neutral detergent to wash the aluminium frame and glass, to make it bright and clean



**Notes for Use:**

- (1) The ground wire need be connecting with the floor when with steam, massage motor function.
- (2) Opening and closing the door more gently to avoid the human error damage. Oil it every month to make it sliding smoothly.
- (3) Using Acid or alkali solution, knife to scrape the shower room are strictly forbidden. Clean, Care and Maintenance it in performed periodically
- (4) Don't let the child or Persons with physical disabilities to take shower alone.
- (5) Don't climb the shower room or handing heavy things on it
- (6) This board is Acrylic which will be turn soft when the temperature over 80 centidegreen, so, please keep below it. Suggestion let-out cold water before hot water.
- (7) Because the Acrylic surface hardness is similar like aluminium alloy, please notice the surface protect when pick-and-place it. Can use 2000# water polishing with nubuck leather, then use tooth paste with silk to make it flat when its damaged.
- (8) Under normal pressure of water it few to let water out when using it, should washing the faucet Valve often and check it if there is block of junk.
- (9) Put on the silicon sealant in time in case of water leakage.
- (10) Open the door to make it keep well-ventilated in case of any moisture to make the shower room get mildewed and produce of flavour.

**Notice:**

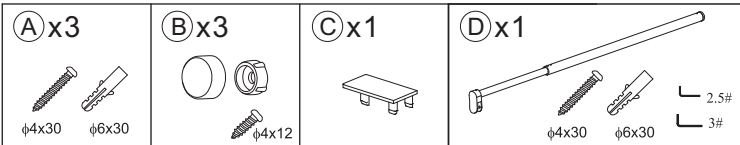
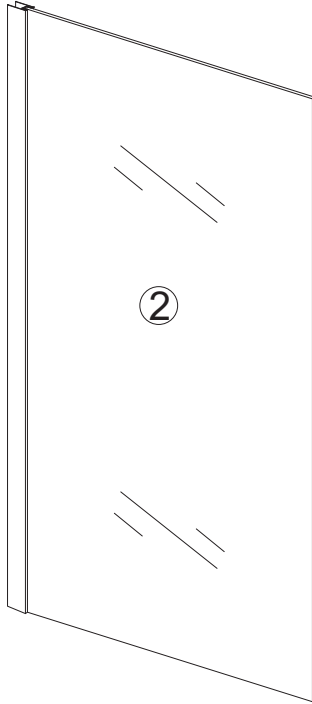
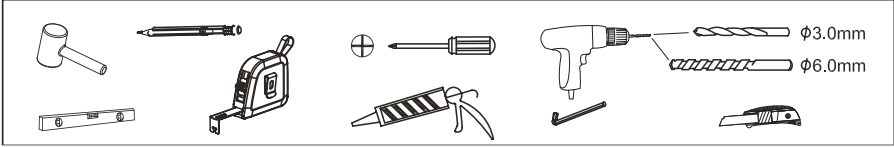
When the glass product is stored in a humid and high temperature sealed environment, if the storage time is too long (more than 10 months), glass surface may produce colorful or white spots and other mildew phenomenon. Once it happens, please use 50% vinegar and 50% water mixed to clean the glass surface with cotton cloth.



	<b>(A)x3</b>
	 φ4x30    φ6x30

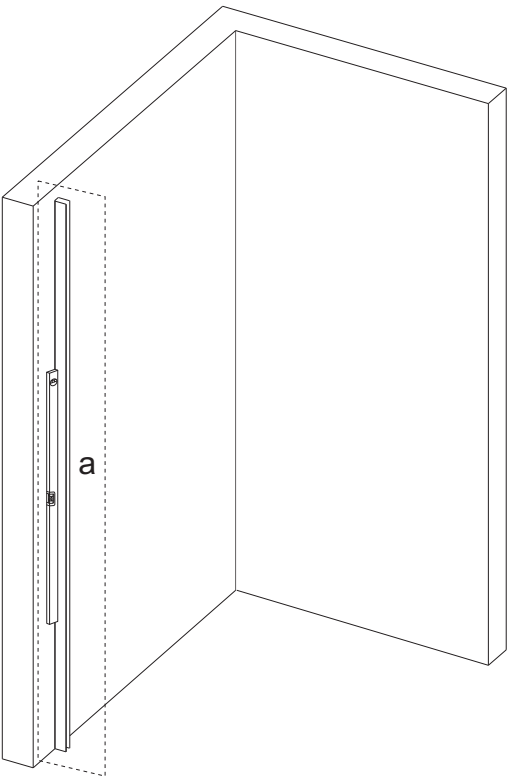
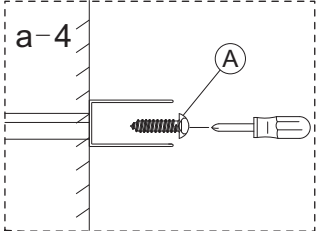
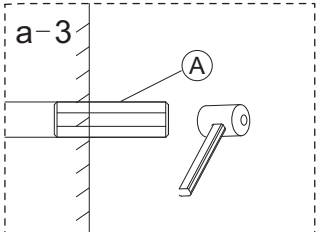
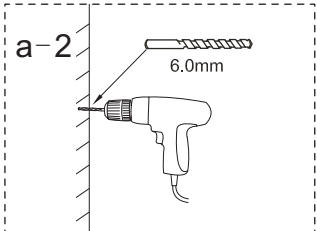
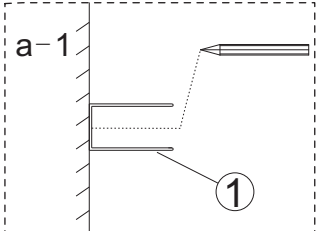

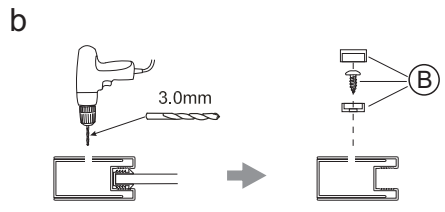
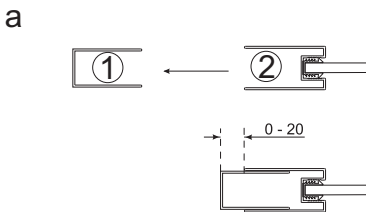
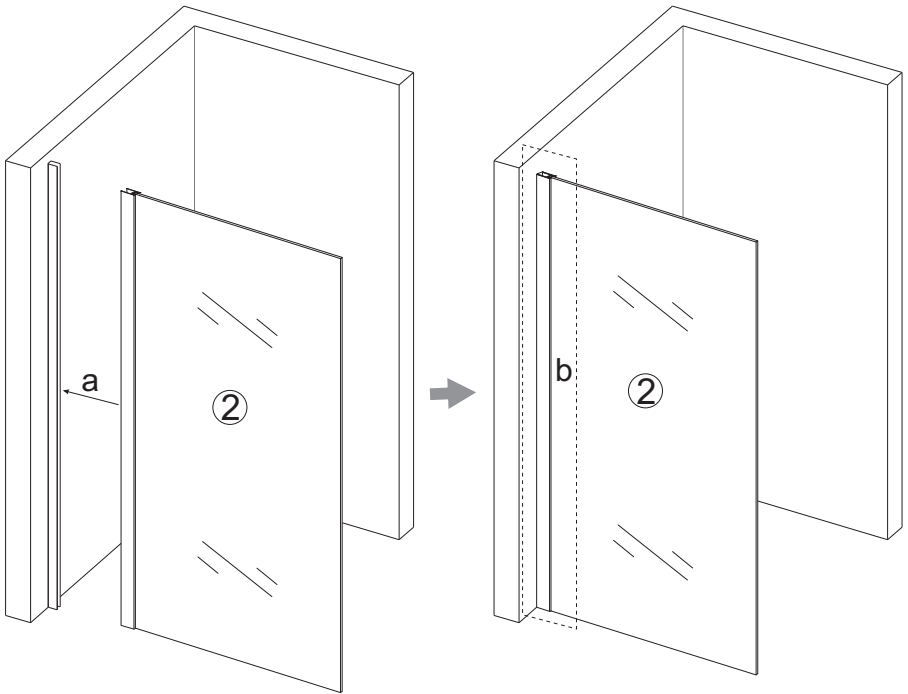
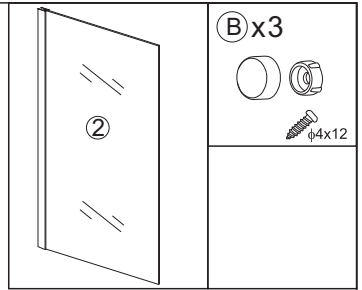

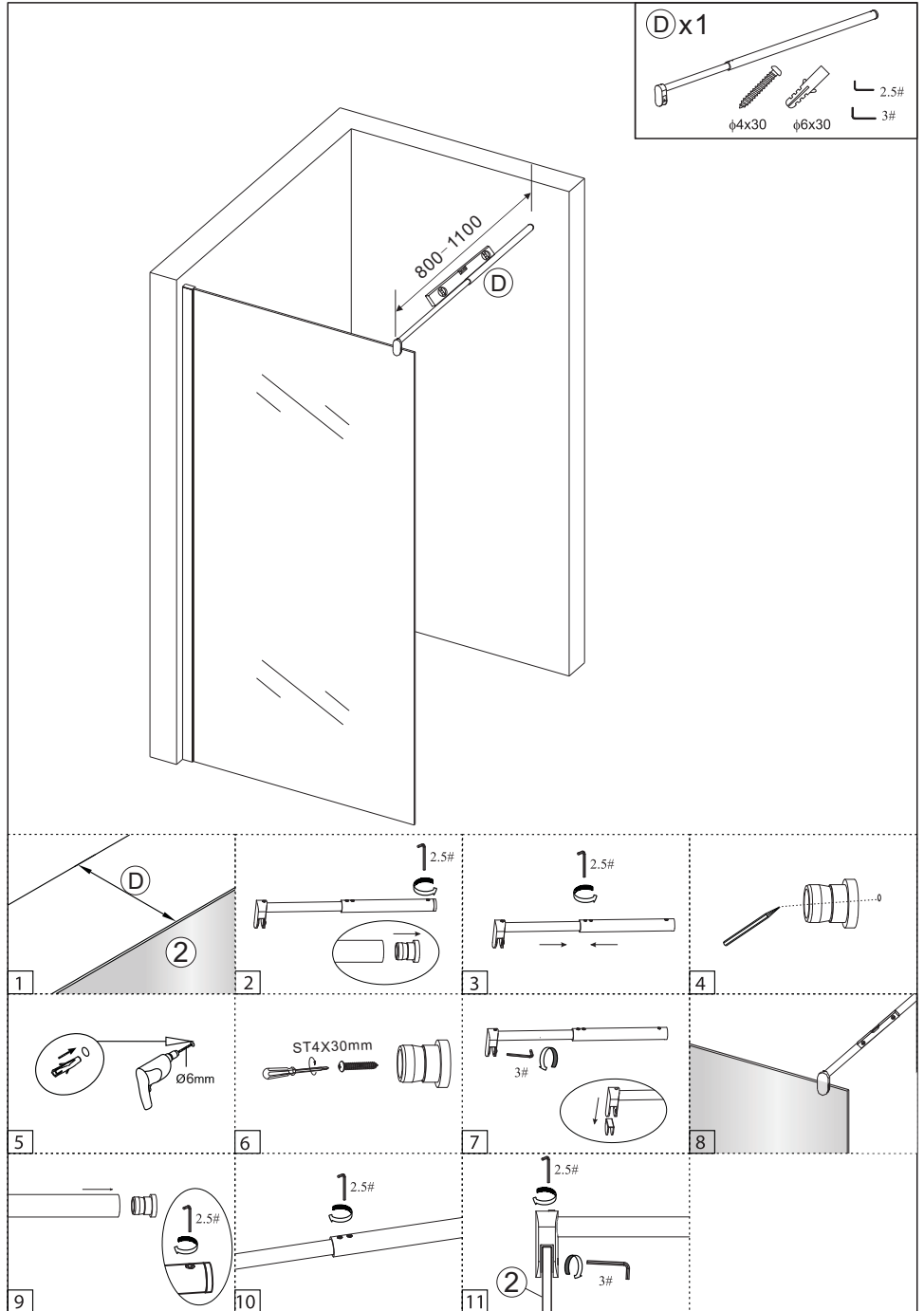

C x1

