

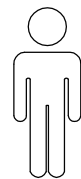

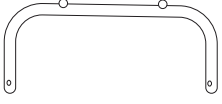









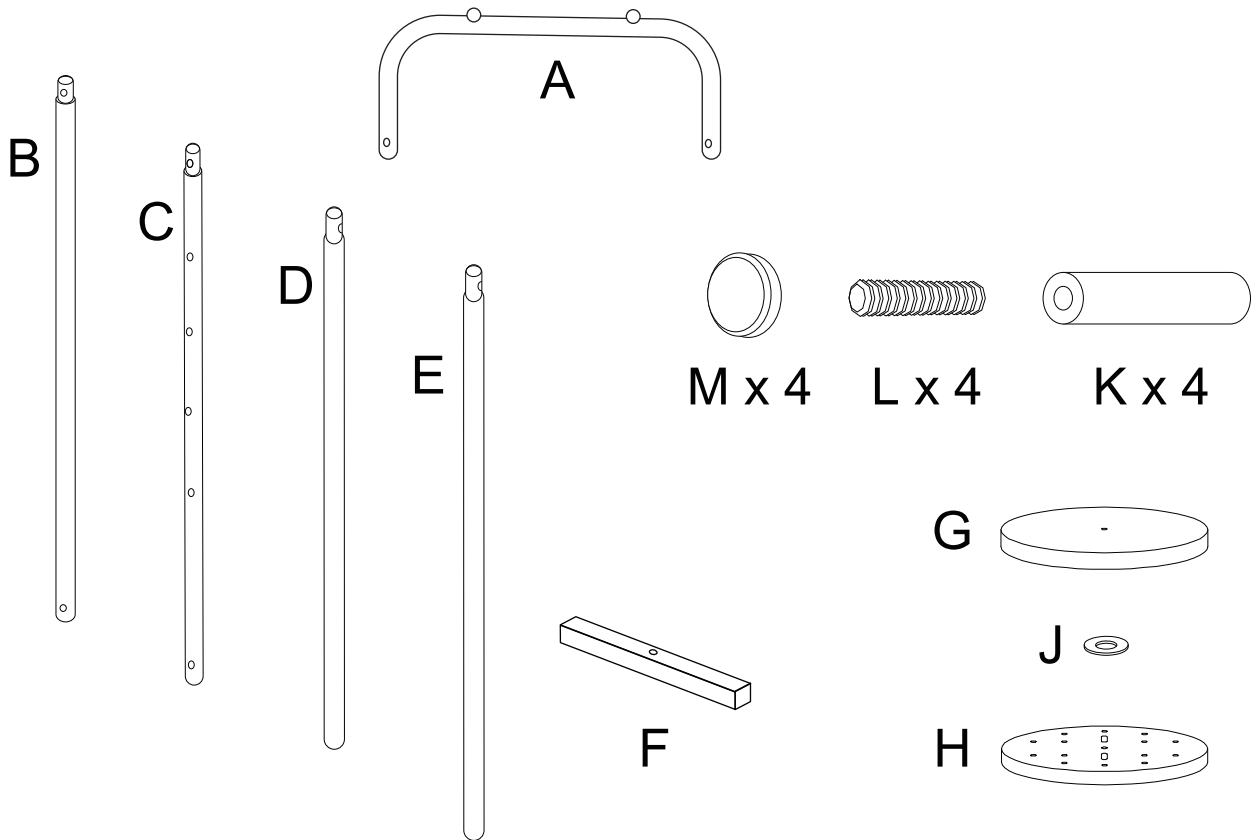

30'

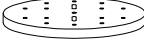

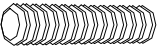

1

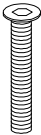
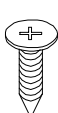
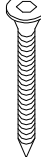
A  x1	B  Ø22 x 820 x1	C  Ø22 x 820 x1	D  Ø22 x 815 x1	E  Ø22 x 830 x1
--	---	---	---	---





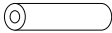

F  x1	G  x1	H  x1	I  x2	J  x1	K  x4	R  x1
L  x4	M  x4	N  M6 x 35 x5	O  M4 x 12 x4	P  M6 x 45 x1	Q  x1	

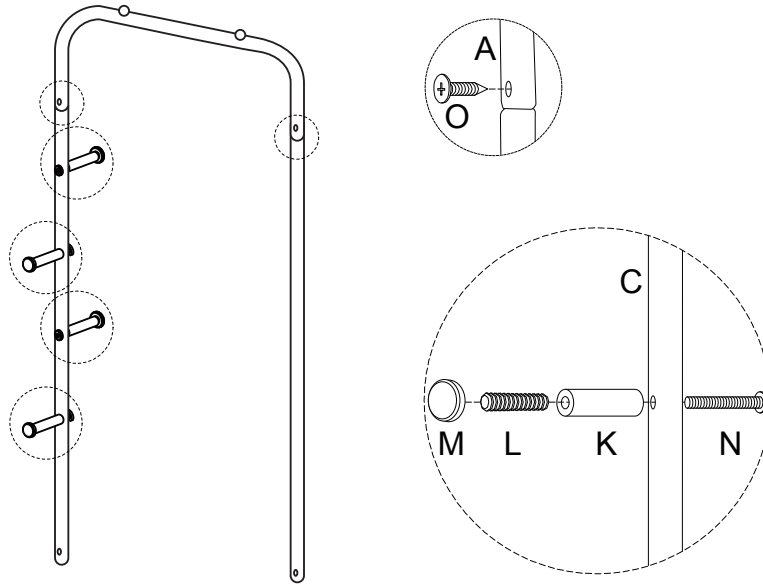
1

A  x1	B Ø22 x 820 x1	C Ø22 x 820 x1	K  x4	L  x4	M  x4	N M6 x 35 x4	O M4 x 12 x2
---	-----------------------------------	-----------------------------------	---	--	---	---------------------------------	---------------------------------

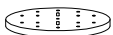

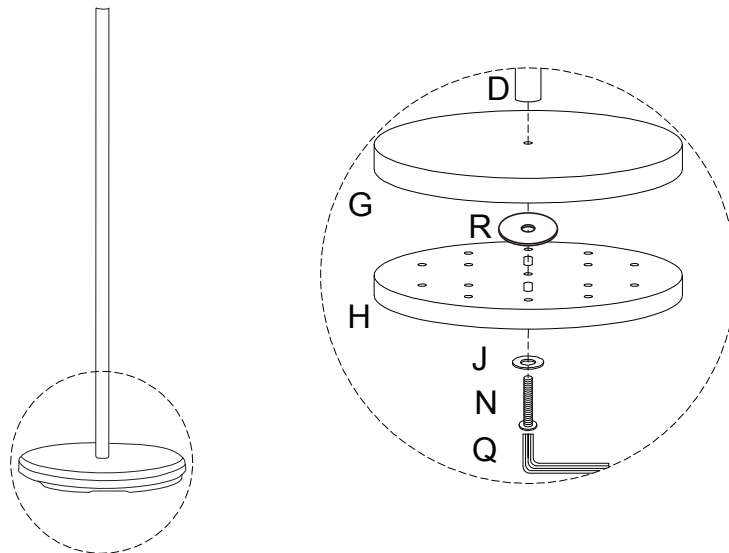

2

D Ø22 x 815 x1	G  x1	H  x1	J  x1	N M6 x 35 x1	Q  x1	R  x1
-----------------------------------	---	---	---	---------------------------------	---	---

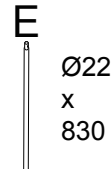

3

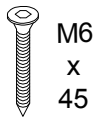
<p>E</p>  <p>Ø22 x 830</p> <p>x 1</p>	<p>F</p>  <p>x 1</p>	<p>I</p>  <p>x 2</p>	<p>P</p>  <p>M6 x 45</p> <p>x 1</p>
---	--	---	---

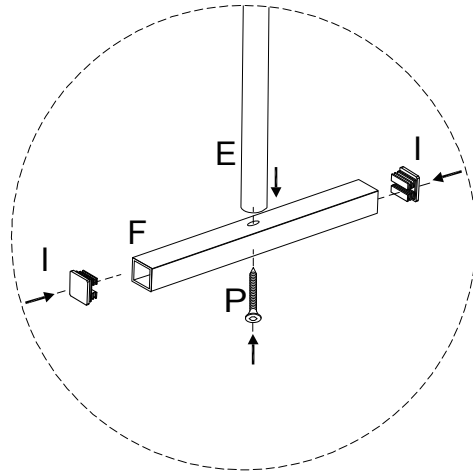
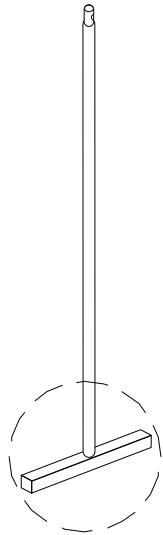

4

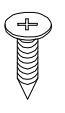
<p>O</p>  <p>M4 x 12</p> <p>x 2</p>

