

45'

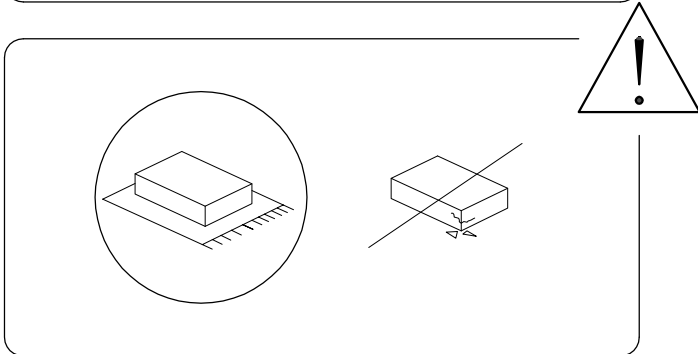

1

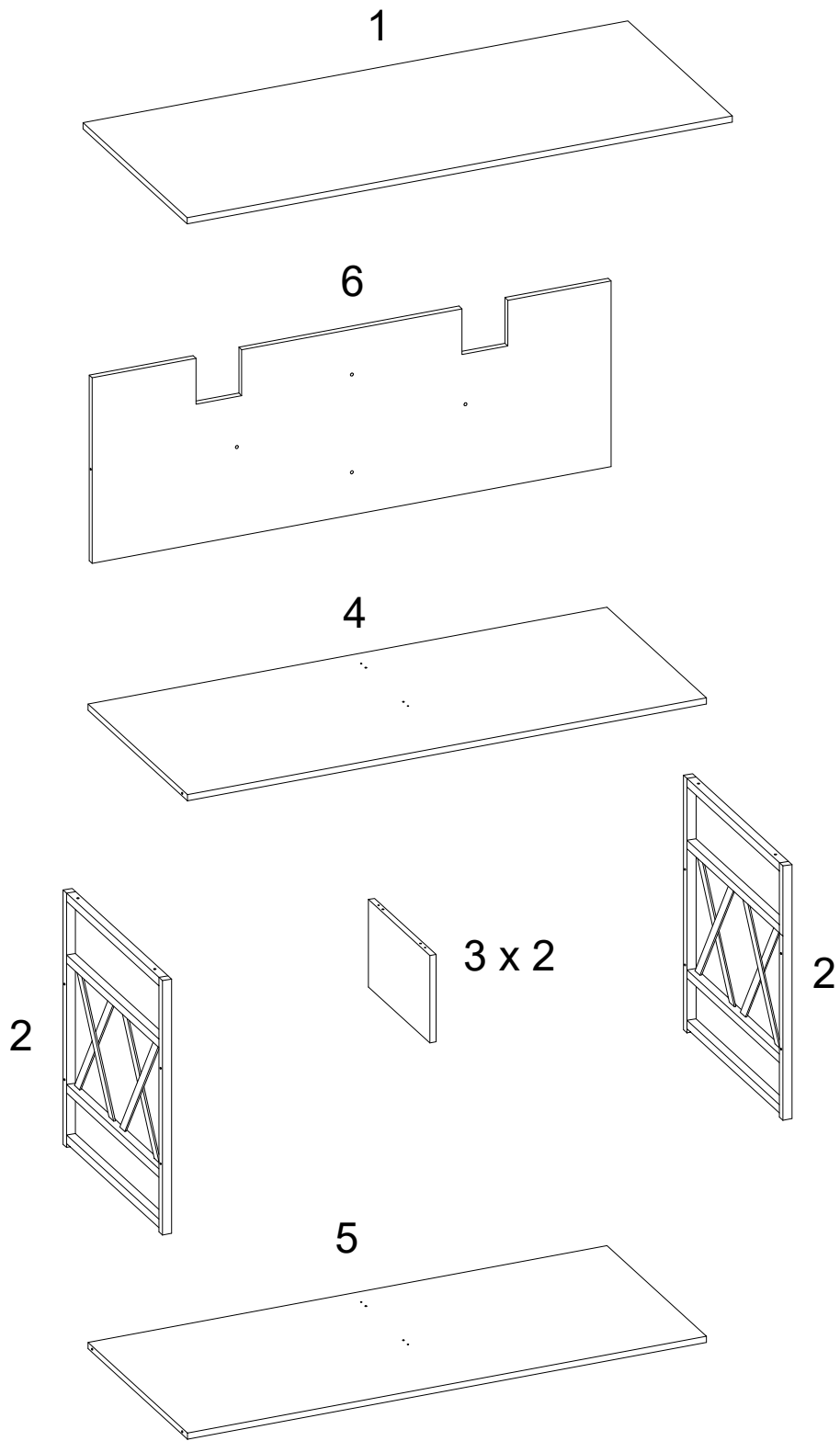

1

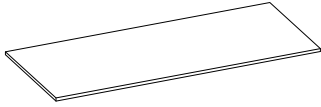

x 1

2

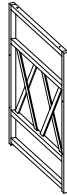

x 2

3

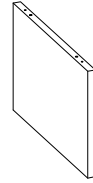

x 2

4

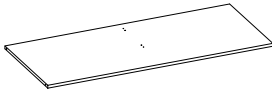

x 1

5

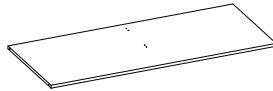

x 1

6

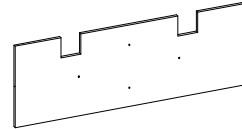

x 1

A

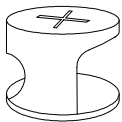

x 4

B

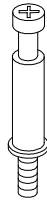

x 4

C



Ø6
x
30

x 8

D

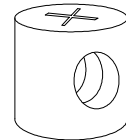

x 8

E

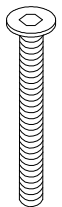

M 6
x
55

x 8

F

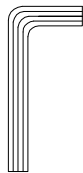

x 1

G

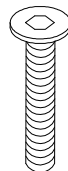

M 6
x
30

x 4

H

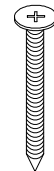

4
x
40

x 8

1

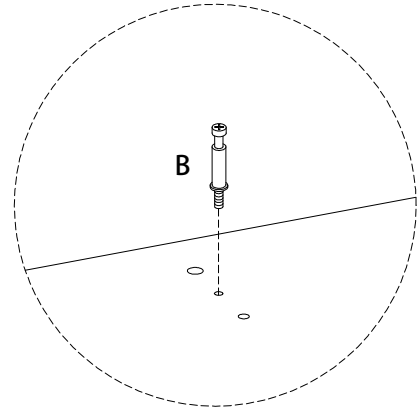
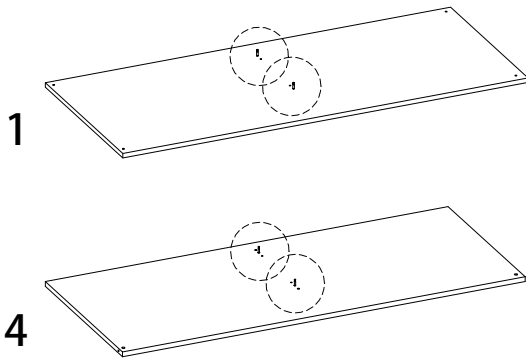
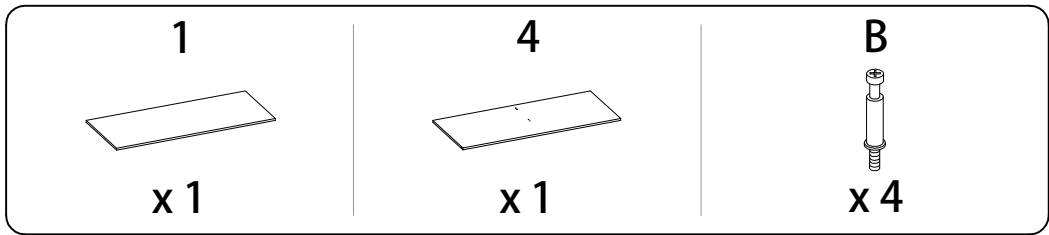

2

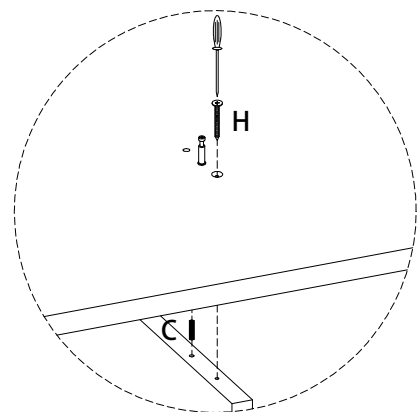
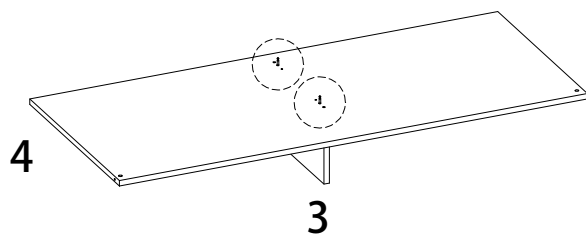
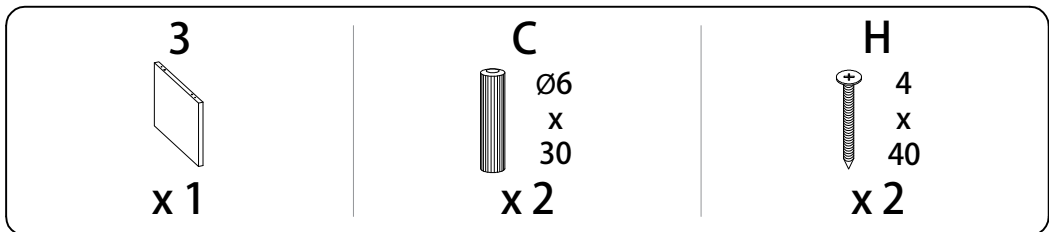

3

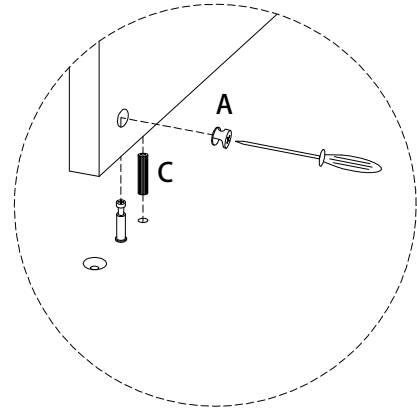
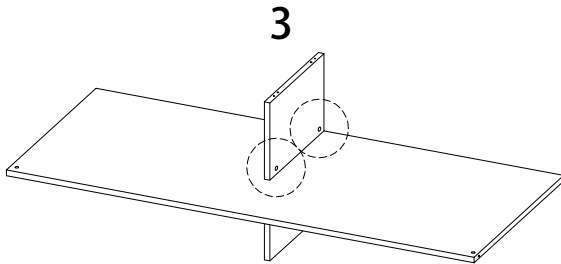
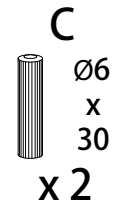
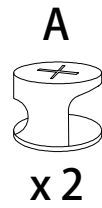
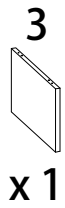

4

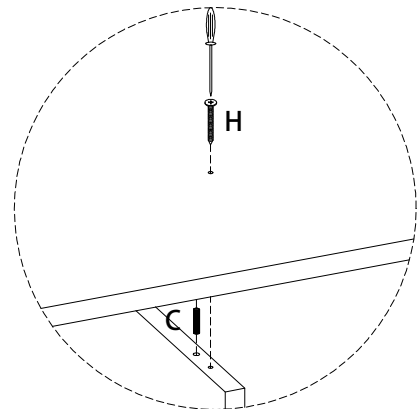
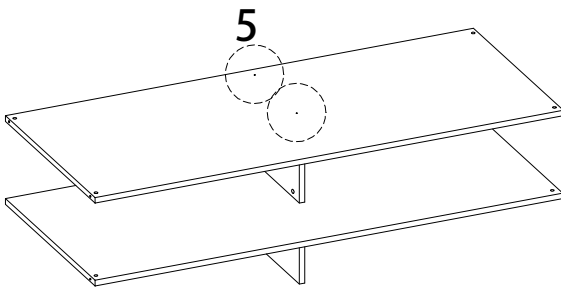
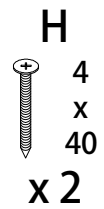
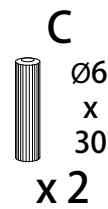
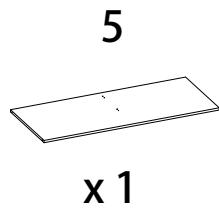

5

D



x 6

E

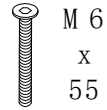

x 6

F

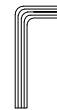

x 1

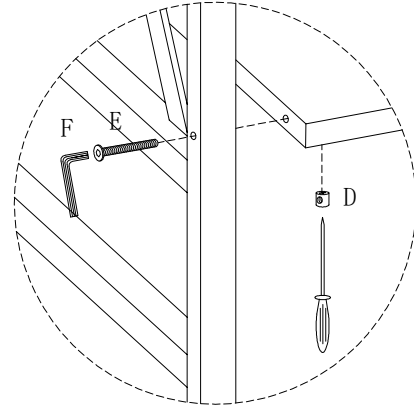
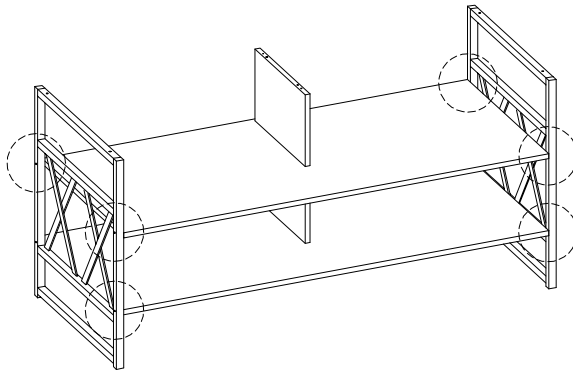

6

6

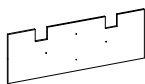

x 1

D



x 2

E

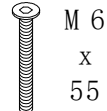

x 2

F



x 1

H

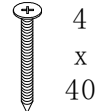

x 4

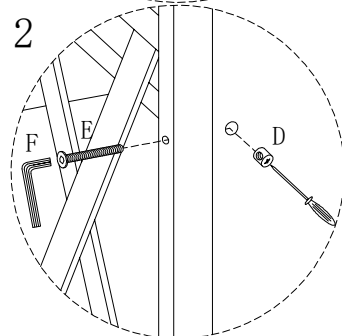
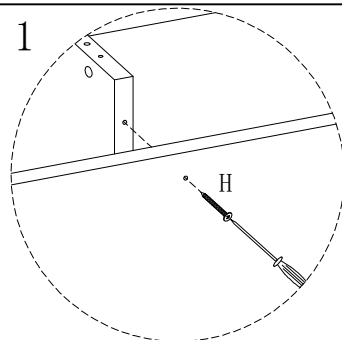
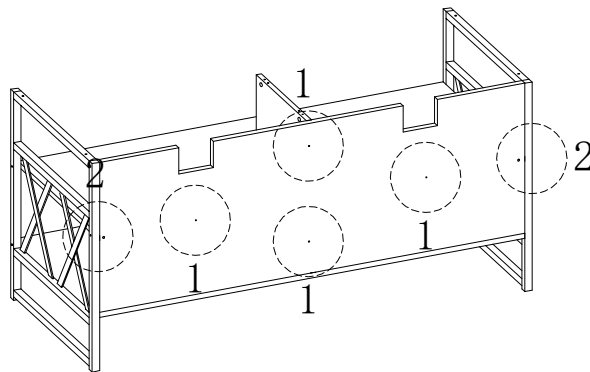

7

