

Technical specifications and safety information for the lamp fixture:

- Tools:** A box containing icons for a screwdriver and a power drill, with a warning triangle above it.
- Time:** A clock icon with the text "15'" below it, indicating an estimated installation time of 15 minutes.
- Warnings:** A box containing a lightning bolt icon, with a warning triangle above it, indicating electrical hazards.
- Personnel:** An icon of a person with the number "1" below it, indicating that one person is required for installation.

1/4

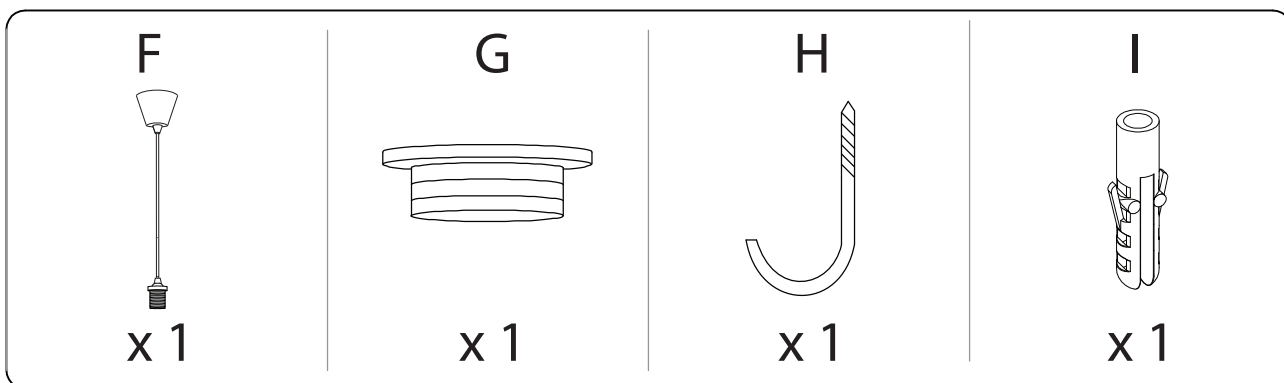
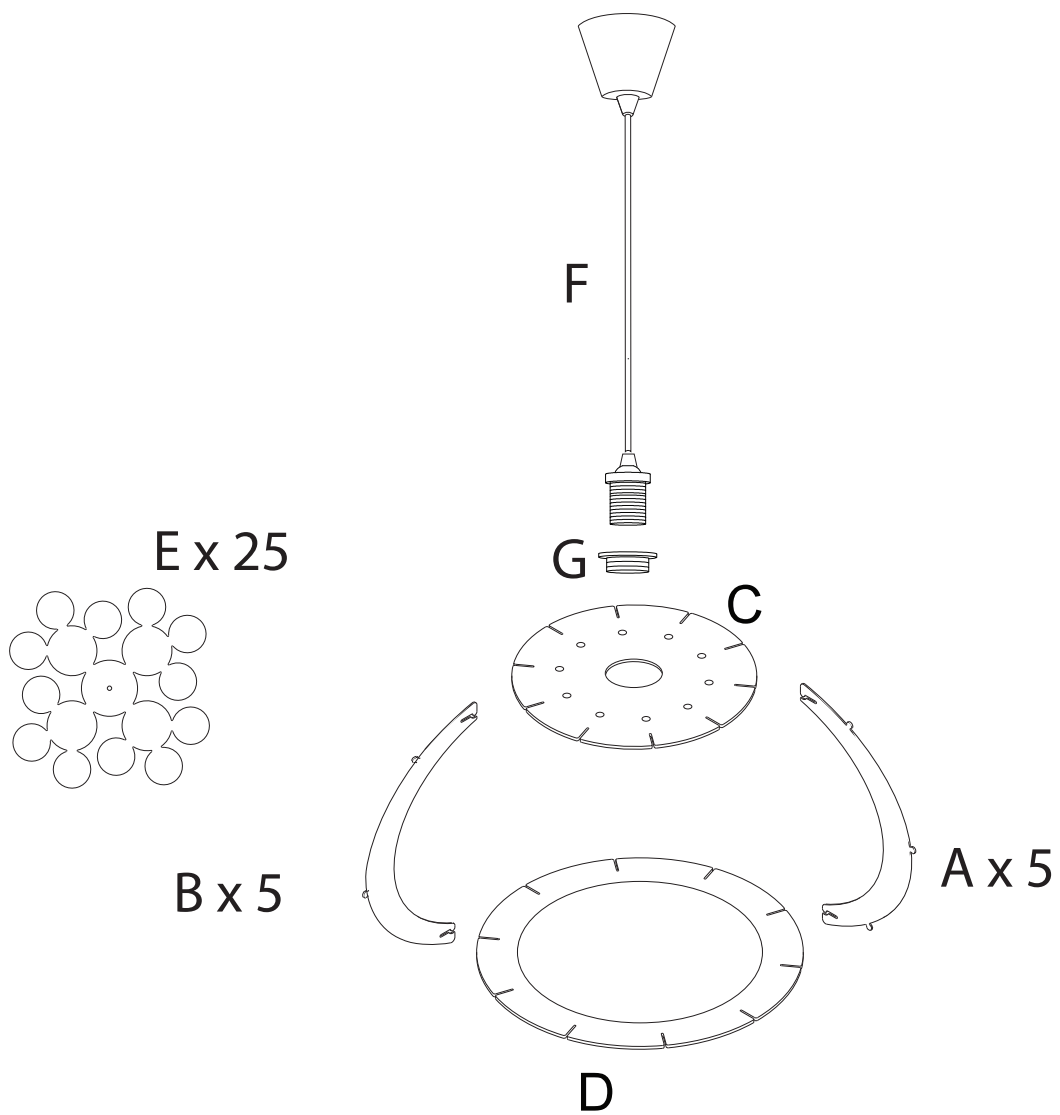
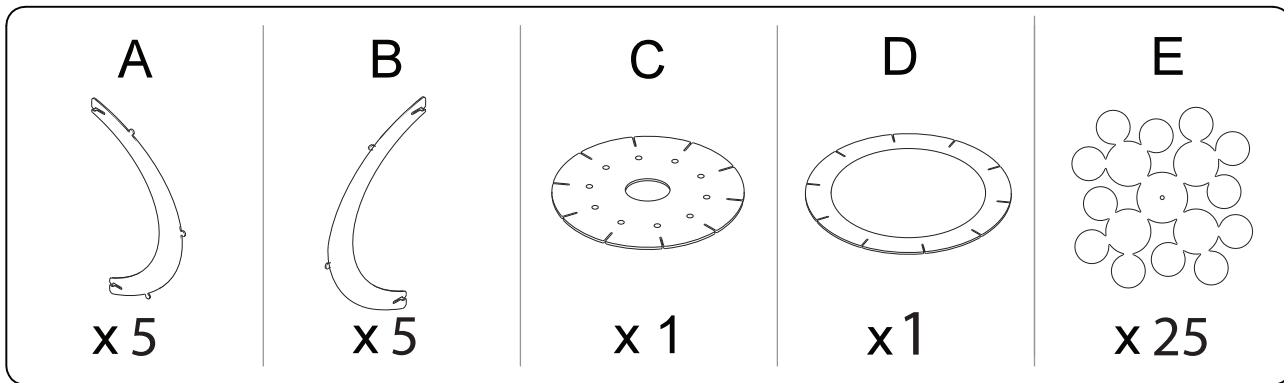

1

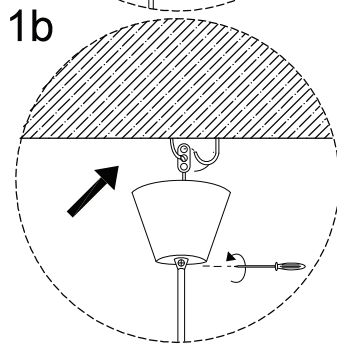
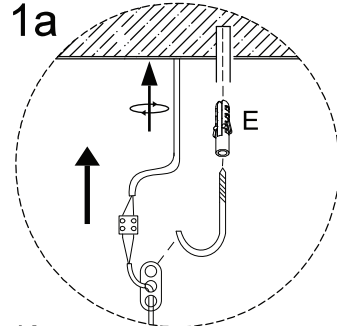
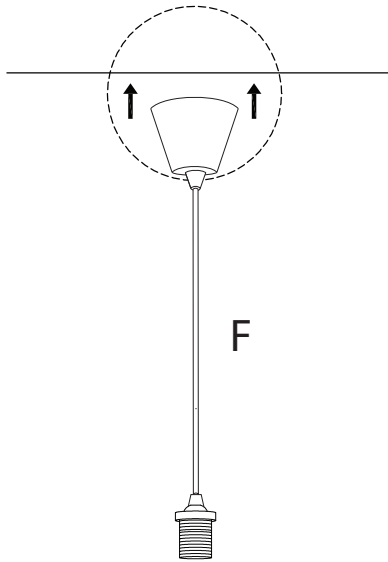
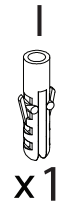
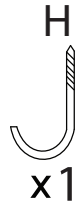

2

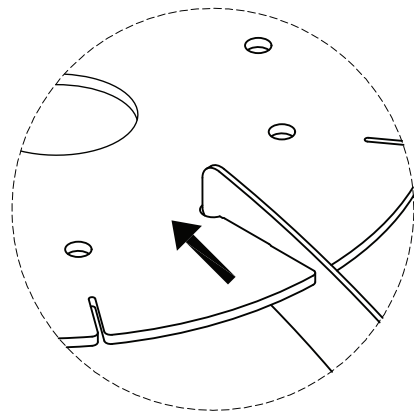
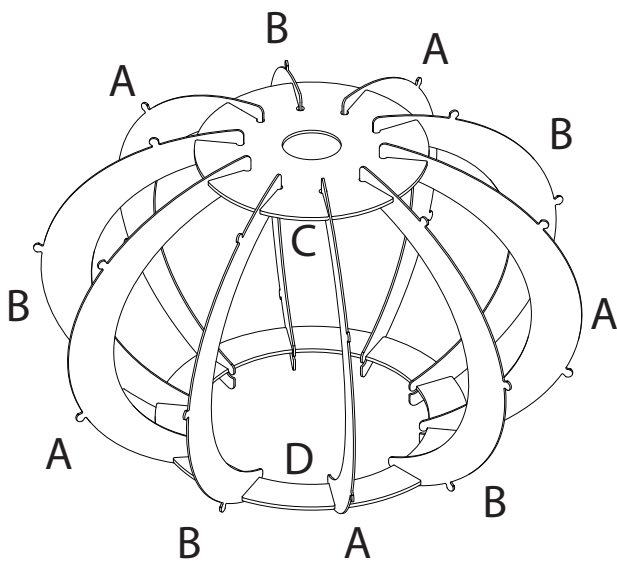
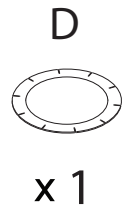
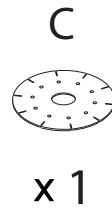

3

E



x 25

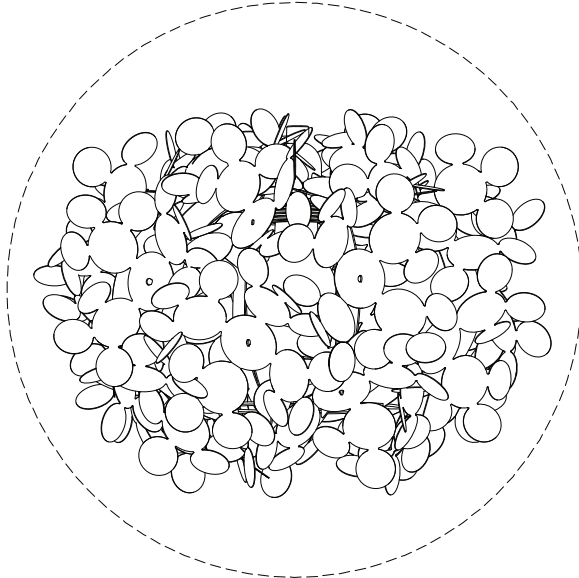

1a

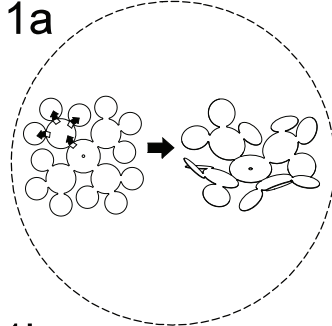

1b

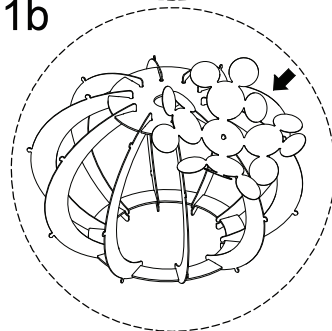

4

G



x 1

F

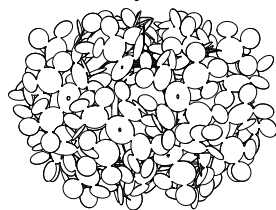

G

