

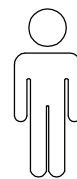

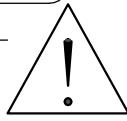

20'

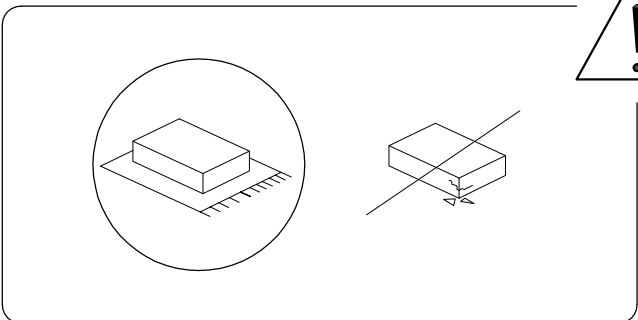





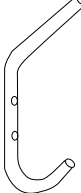
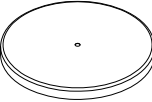

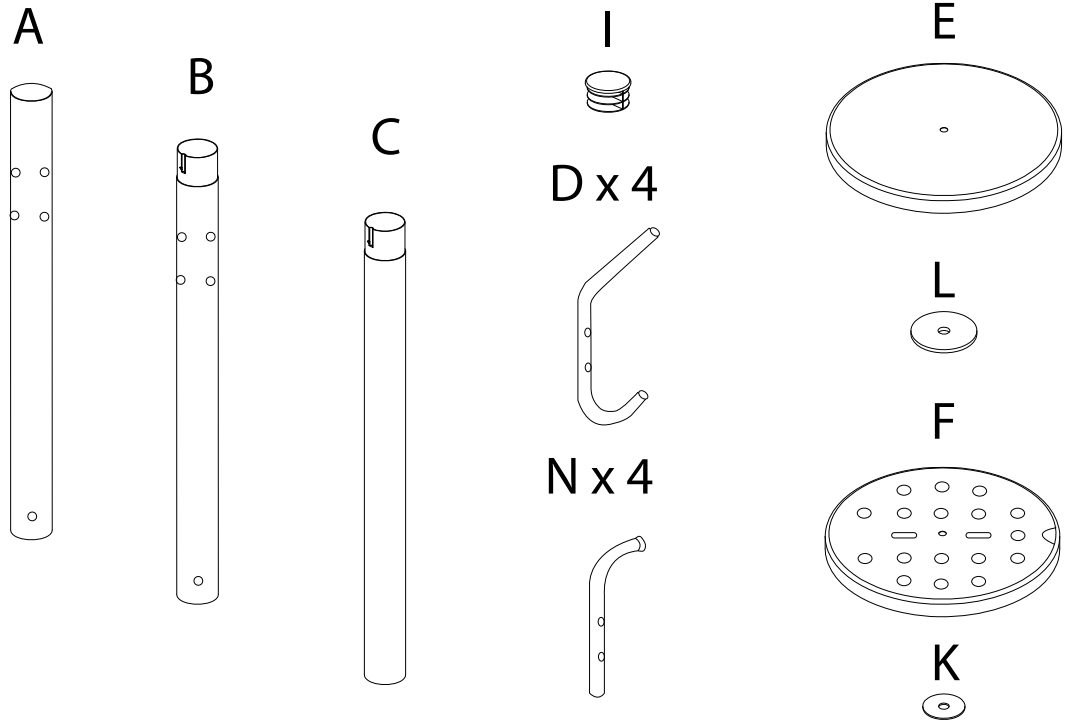

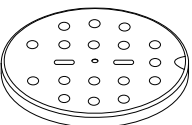
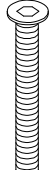
1

1/4

<p>A</p>  <p>x 1</p>	<p>B</p>  <p>x 1</p>	<p>C</p>  <p>x 1</p>	<p>D</p>  <p>x 4</p>	<p>E</p>  <p>x 1</p>
---	---	---	---	---

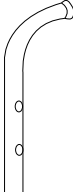

<p>F</p>  <p>x 1</p>	<p>G</p> <p>M8 x 32</p>  <p>x 1</p>	<p>H</p> <p>M4.5 x 25</p>  <p>x 16</p>	<p>I</p>  <p>x 1</p>	<p>J</p>  <p>x 16</p>
<p>K</p>  <p>x 1</p>	<p>L</p>  <p>x 1</p>	<p>M</p>  <p>x 1</p>	<p>N</p>  <p>x 4</p>	<p>O</p>  <p>x 1</p>

1

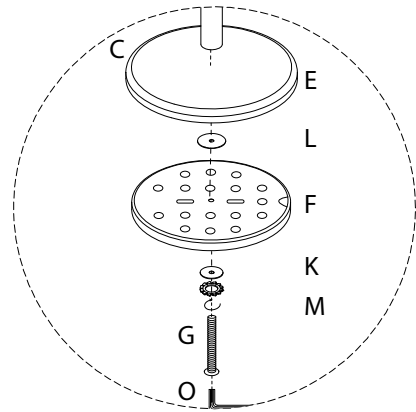
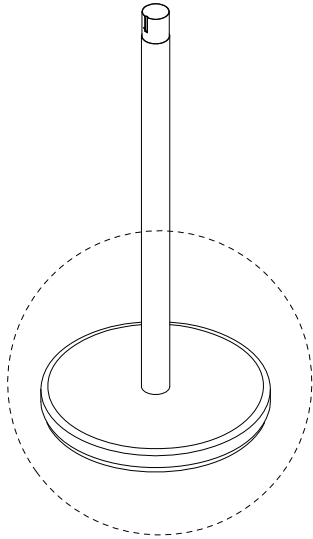
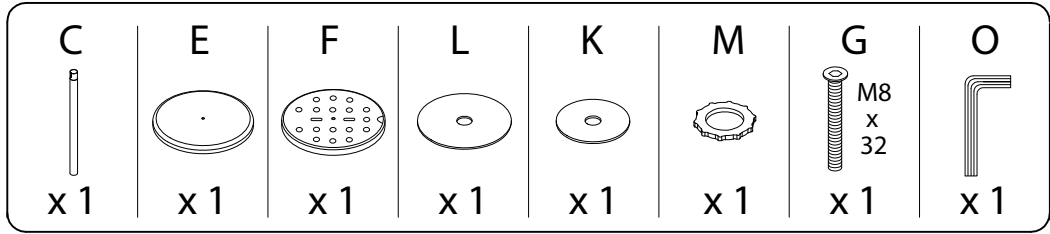

2

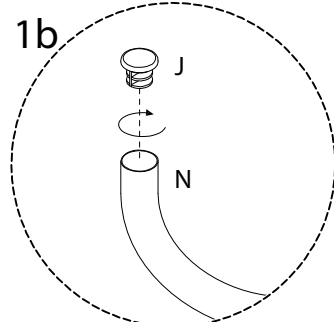
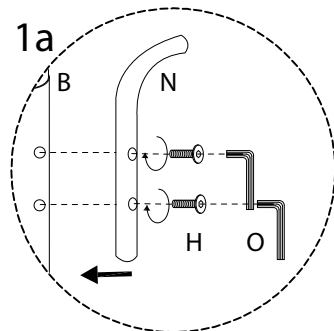
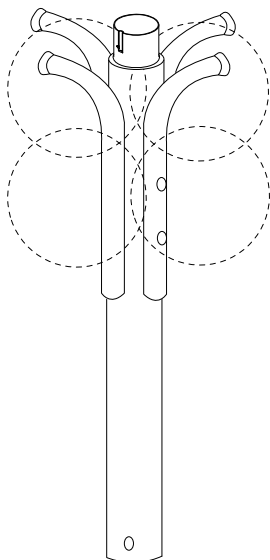
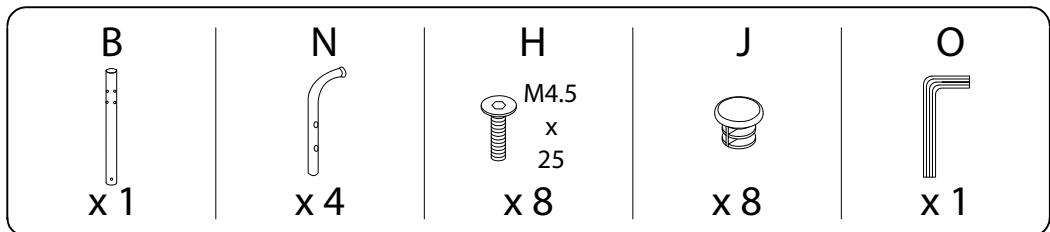

3

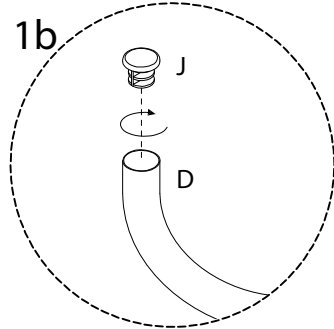
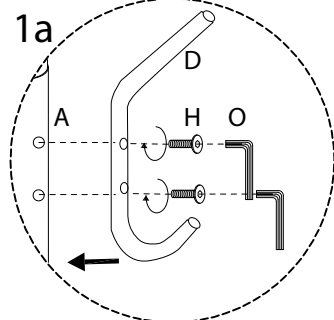
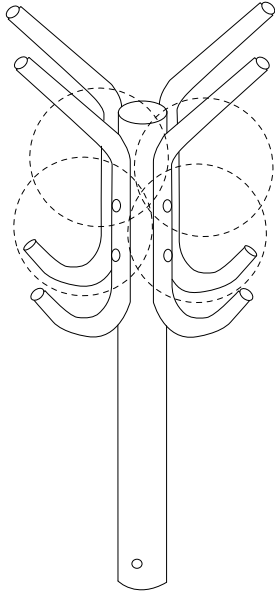
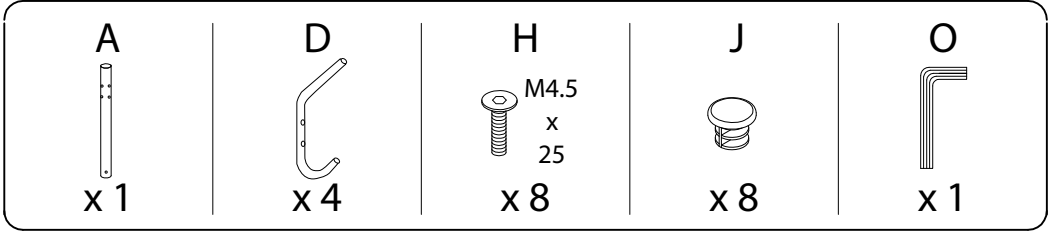

4

