

20'

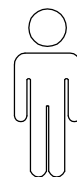

1

1/6

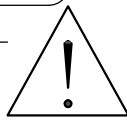
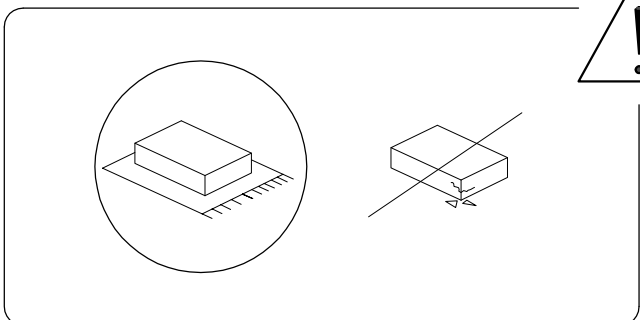
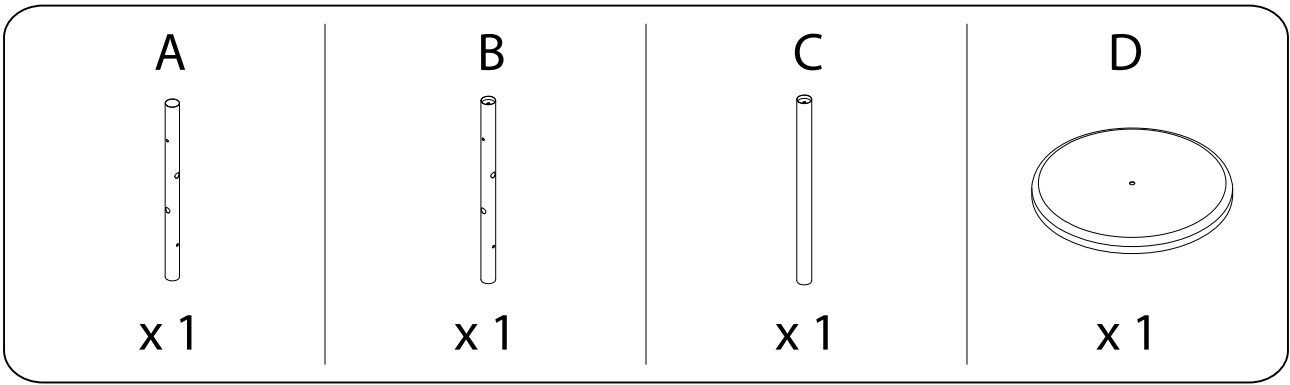

**A**

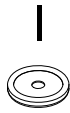

**B**



**C**



**F x 8**

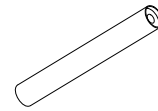

**H x 8**



**D**

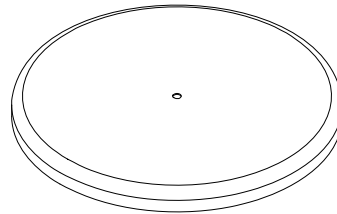





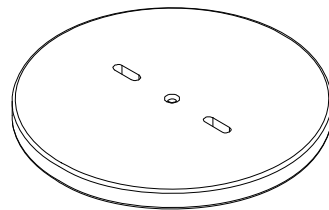

**J**

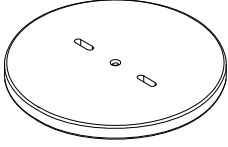
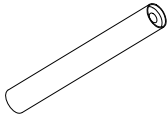

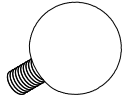
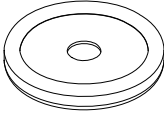
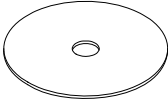
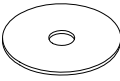
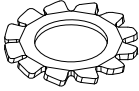
**E**

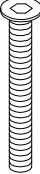

<p style="text-align: center;"><b>E</b></p>  <p style="text-align: center;"><b>x 1</b></p>	<p style="text-align: center;"><b>F</b></p>  <p style="text-align: center;"><b>x 8</b></p>	<p style="text-align: center;"><b>G</b></p>  <p style="text-align: center;"><b>x 1</b></p>	<p style="text-align: center;"><b>H</b></p>  <p style="text-align: center;"><b>x 8</b></p>
<p style="text-align: center;"><b>I</b></p>  <p style="text-align: center;"><b>x 2</b></p>	<p style="text-align: center;"><b>J</b></p>  <p style="text-align: center;"><b>x 1</b></p>	<p style="text-align: center;"><b>K</b></p>  <p style="text-align: center;"><b>x 1</b></p>	<p style="text-align: center;"><b>L</b></p>  <p style="text-align: center;"><b>x 1</b></p>
<p style="text-align: center;"><b>M</b></p>  <p style="text-align: center;">M8 x 61</p> <p style="text-align: center;"><b>x 2</b></p>	<p style="text-align: center;"><b>N</b></p>  <p style="text-align: center;">M6 x 15</p> <p style="text-align: center;"><b>x 8</b></p>	<p style="text-align: center;"><b>O</b></p>  <p style="text-align: center;">M8 x 50</p> <p style="text-align: center;"><b>x 1</b></p>	<p style="text-align: center;"><b>P</b></p>  <p style="text-align: center;"><b>x 1</b></p>

1

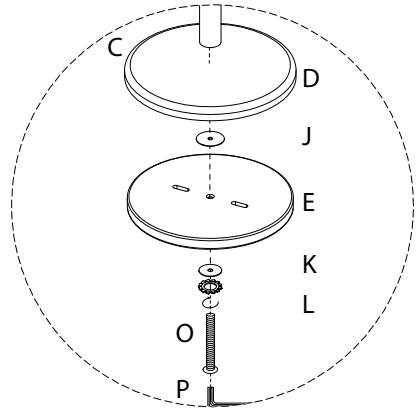
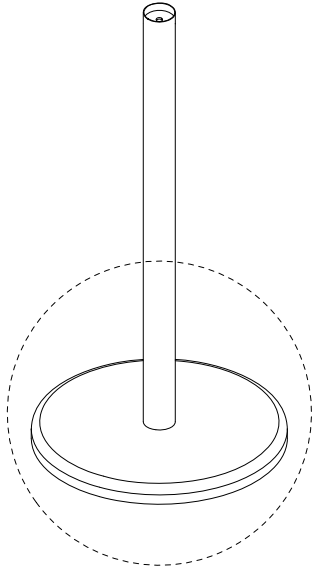
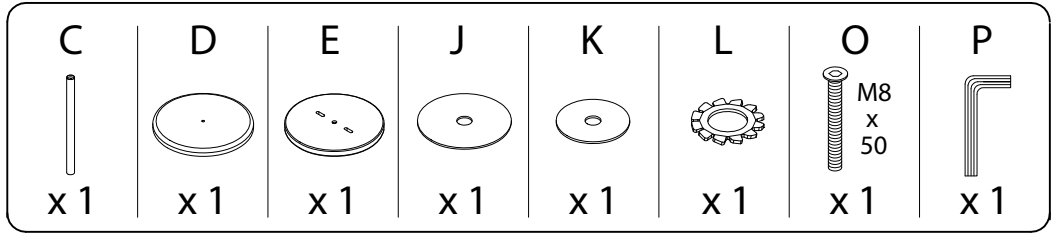

2

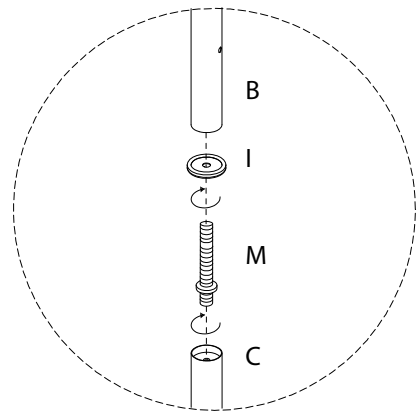
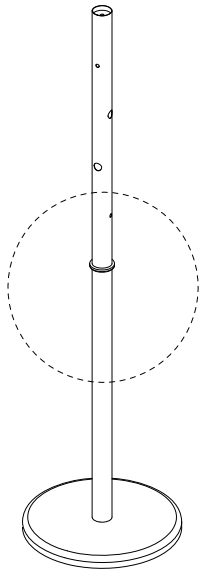
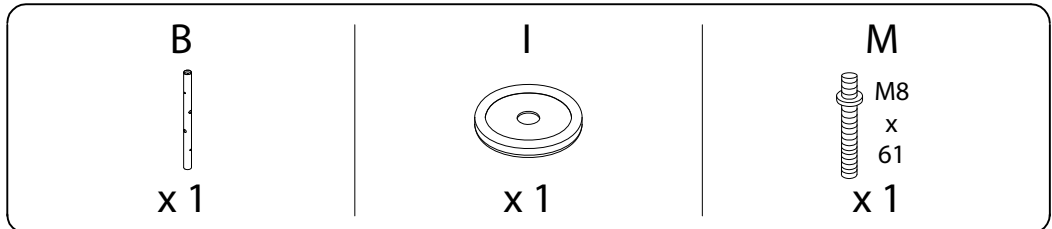

3

A  
x1

I  
x1

M  
M8  
x  
61  
x1

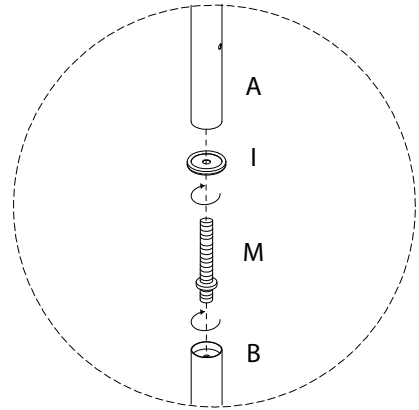
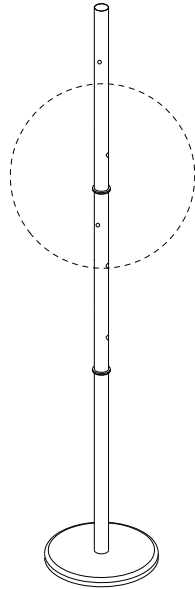

4 x 8

F  
x1

H  
x1

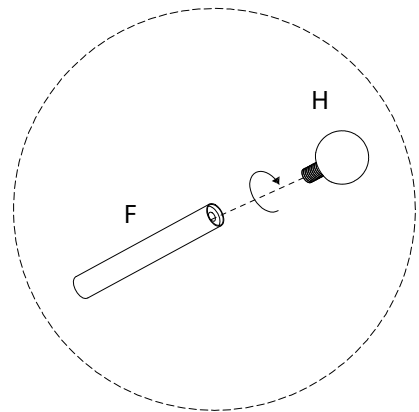
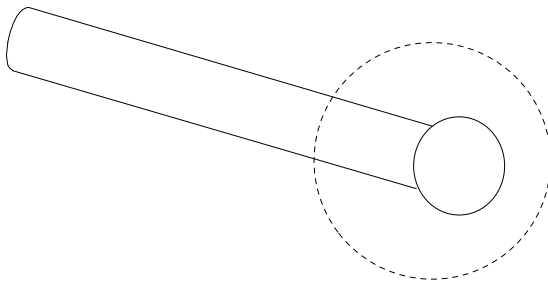

5

N



x 8

P

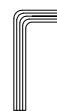

x 1

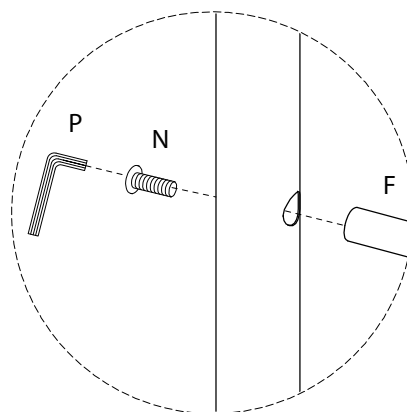
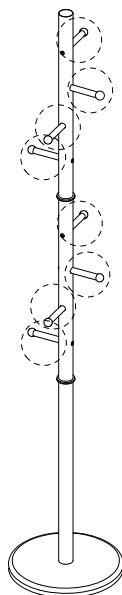

6

G



x 1

