 2

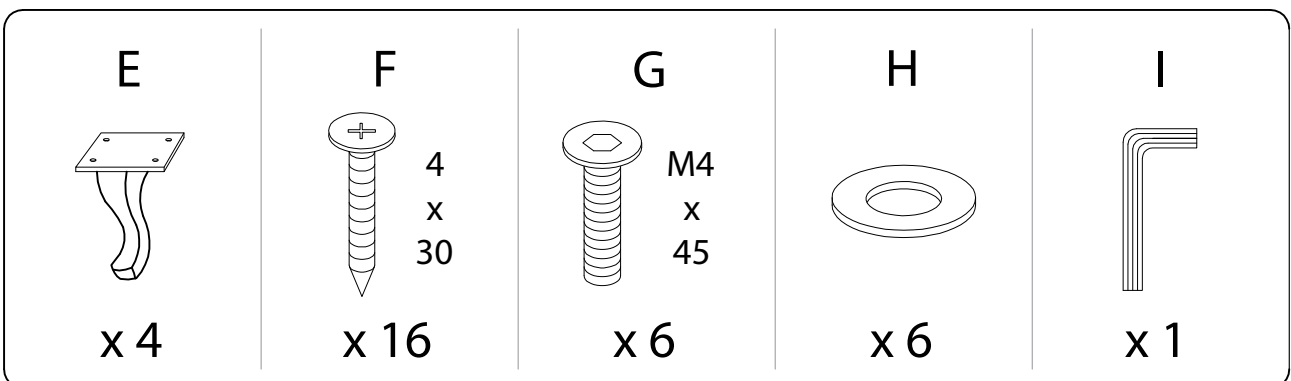

1

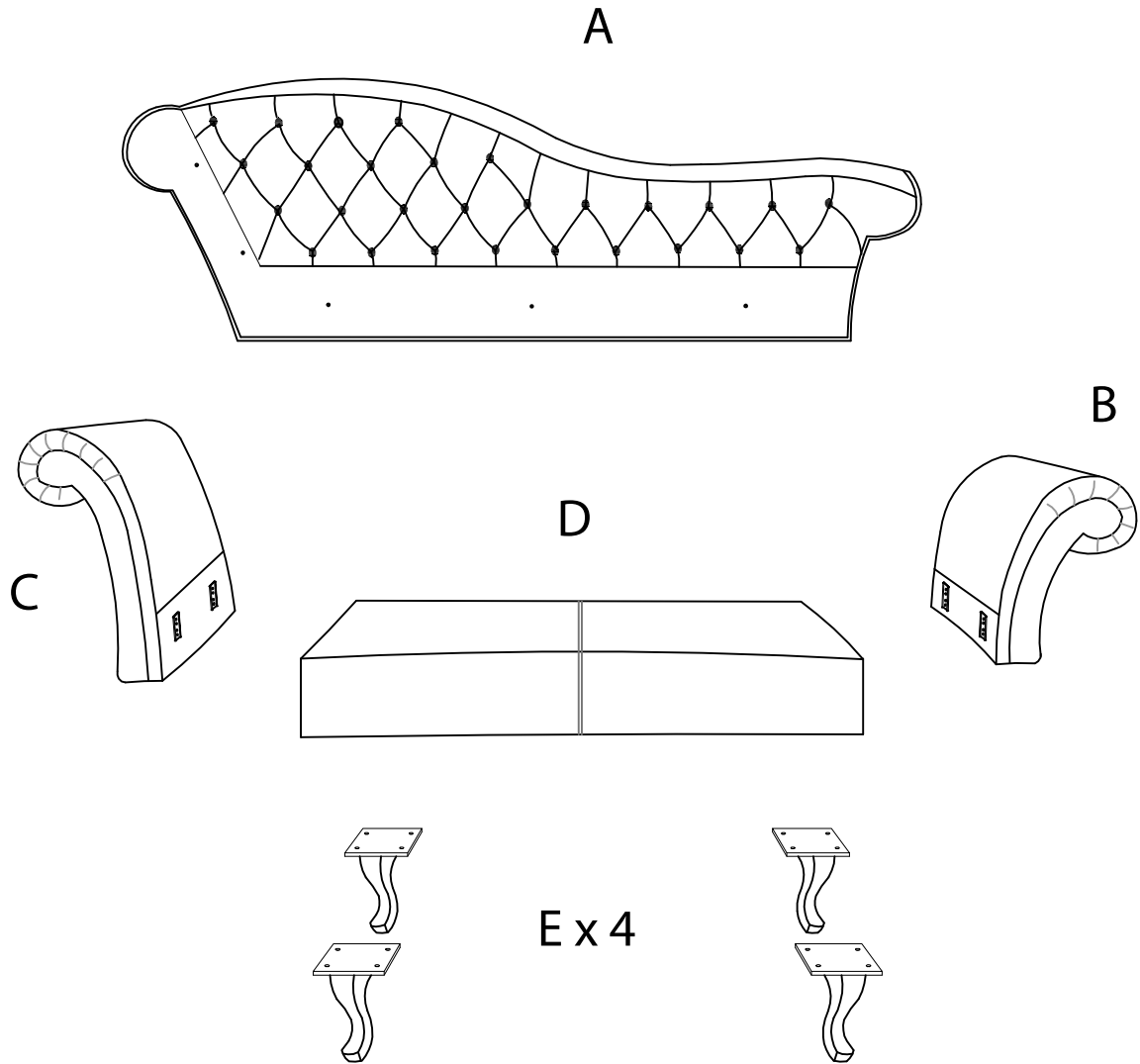

2

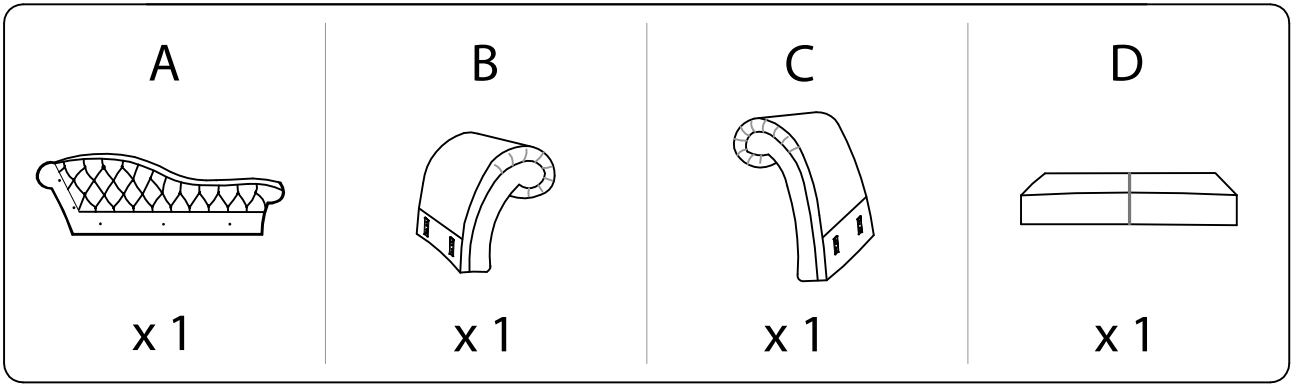
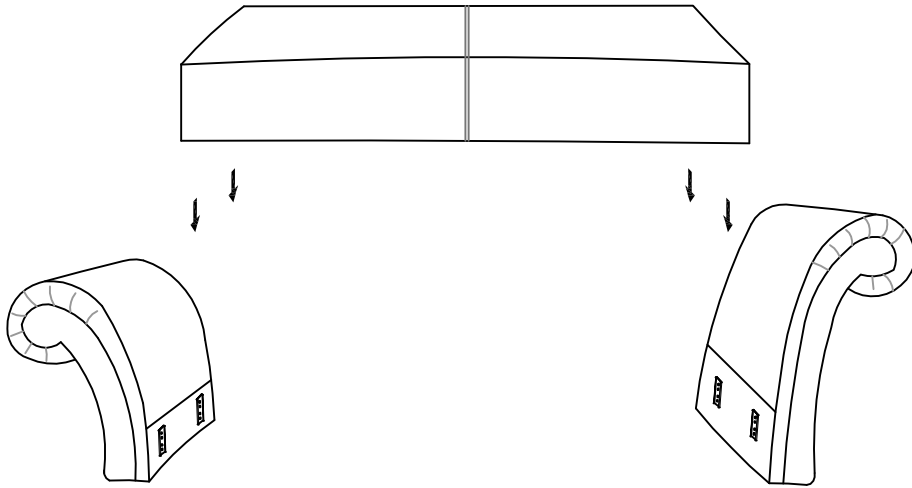
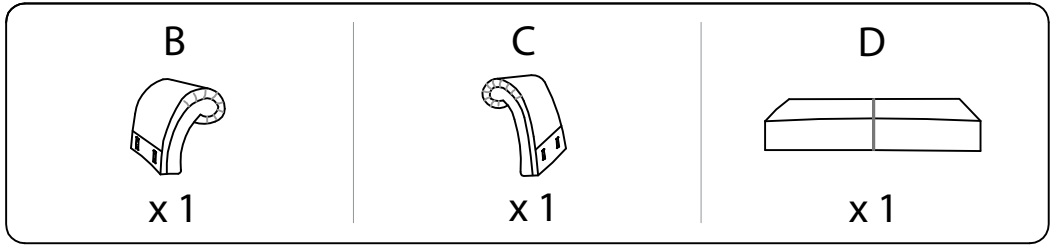
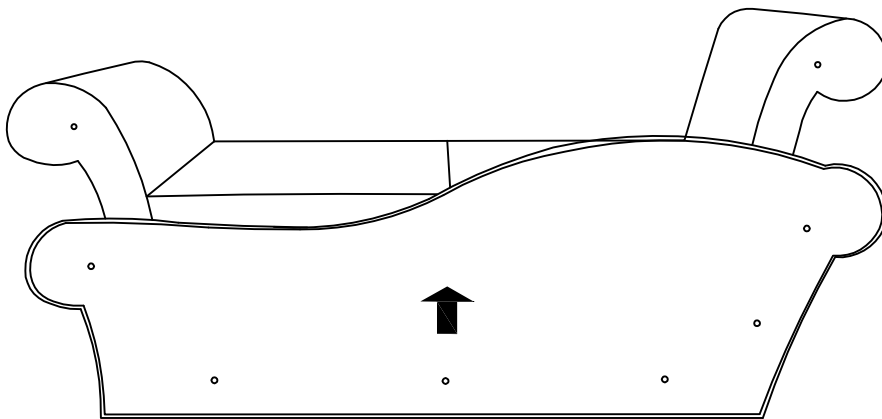
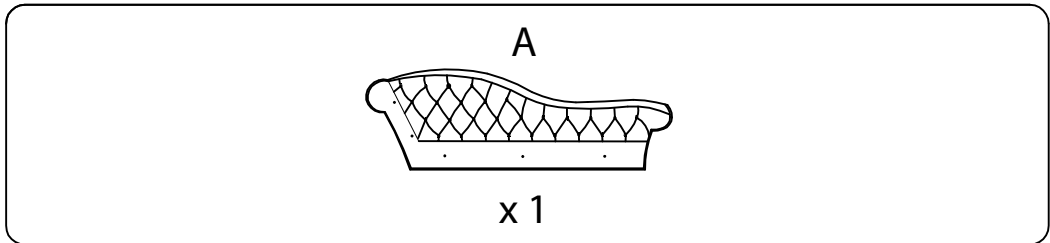

3

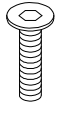
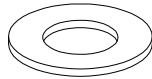
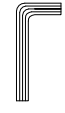
G  M4 x 45 x 6	H  x 6	I  x 1
---	--	--

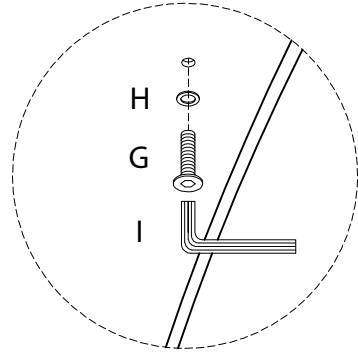
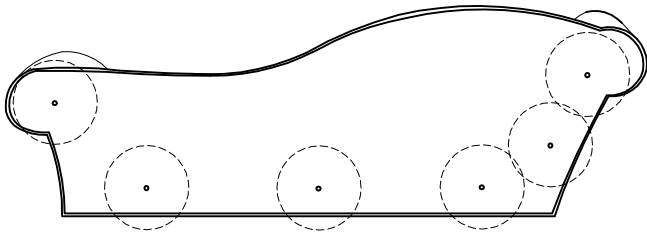

4

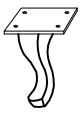
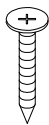
E  x 4	F  4 x 30 x 16
--	---

