

A

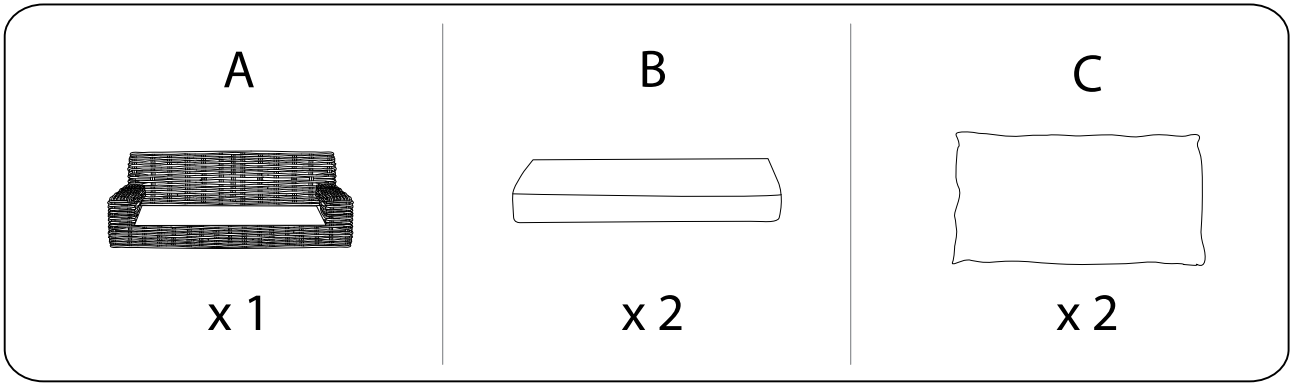

C x 2

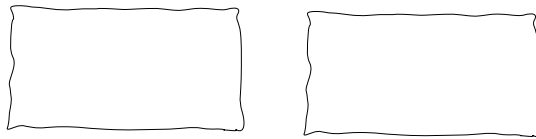

B x 2

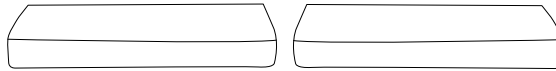

A x 1

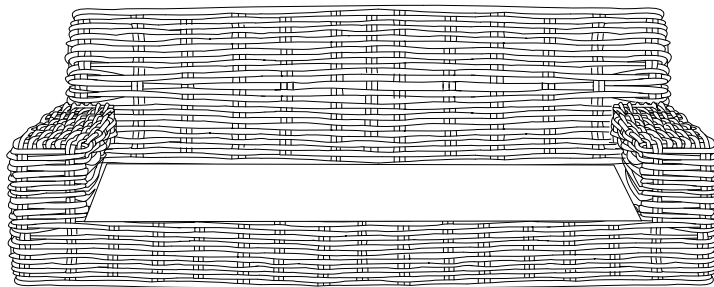

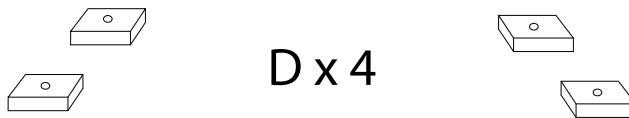

D x 4

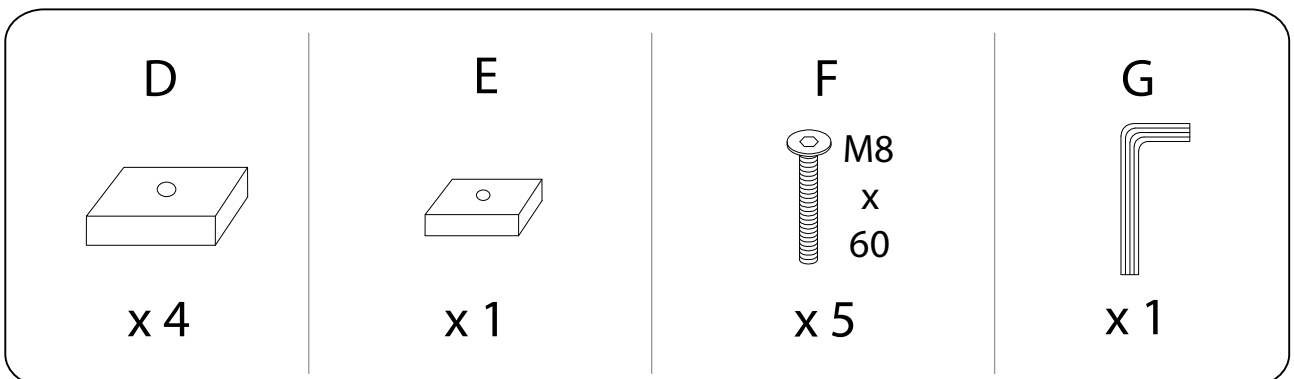

E x 1



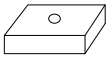

1

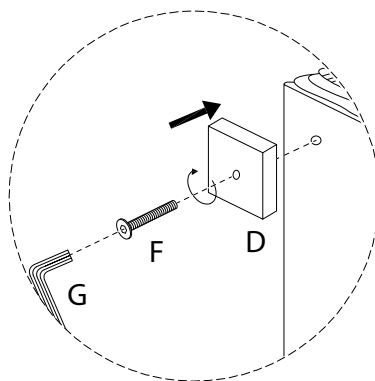
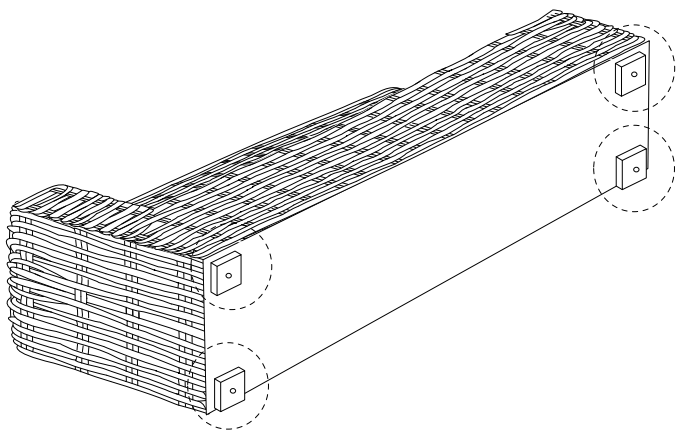
A  x 1	D  x 4	G  x 1	F  x 4
--	--	--	--

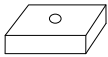

2

E  x 1	G  x 1	F  x 1
--	--	--

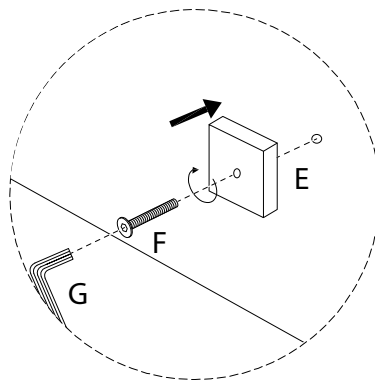
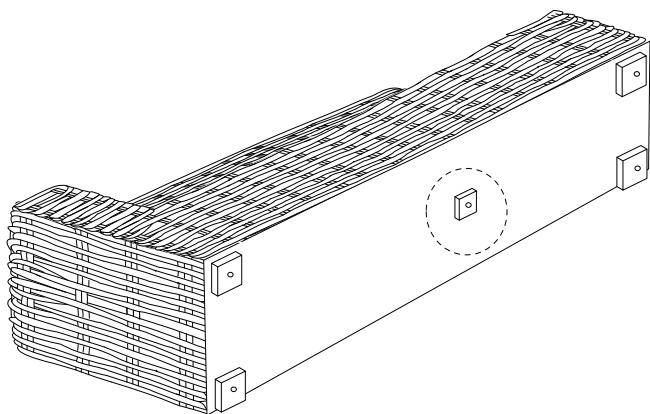

3

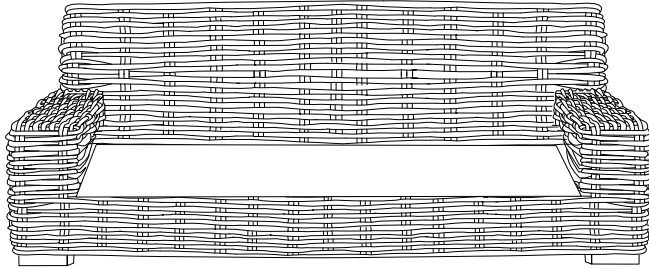
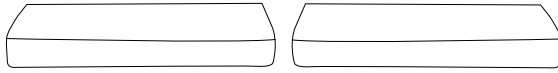
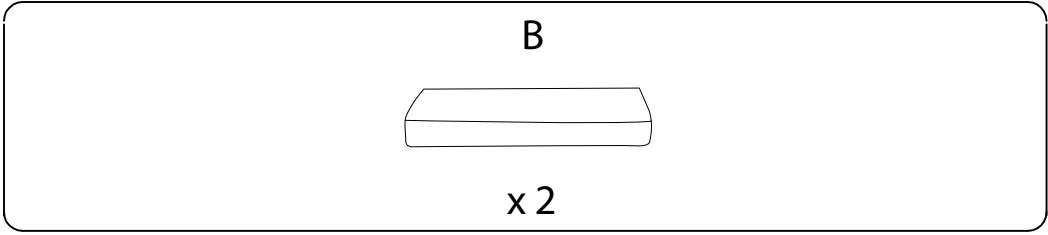

4

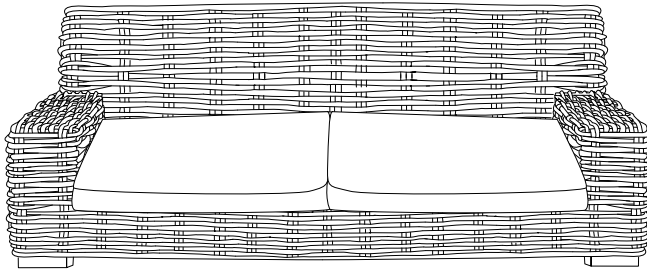
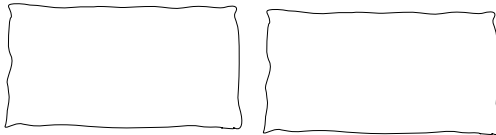
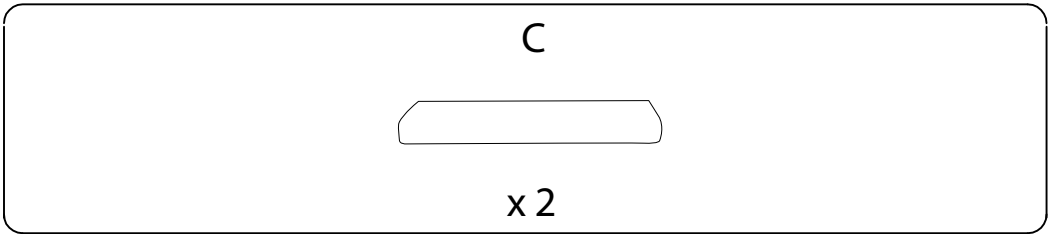

B

A

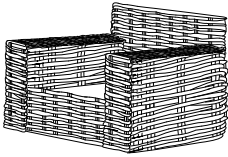

x 1

B

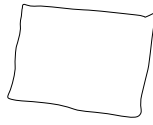

x 1

C



x 1

B x 1

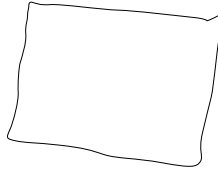

C x 1



A x 1

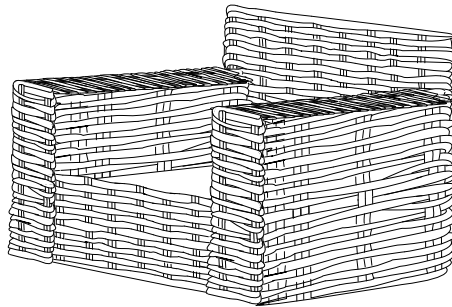

D x 4

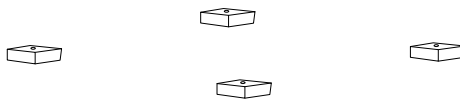

D

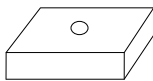

x 4

E

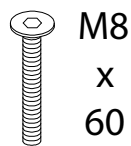

M8
x
60

x 4

F

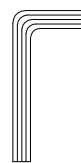

x 1

1

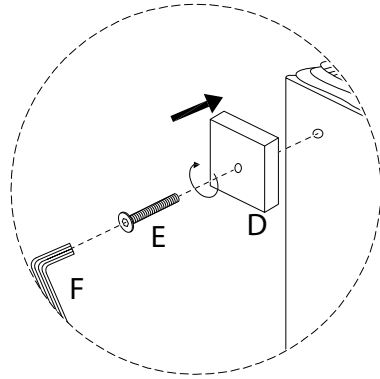
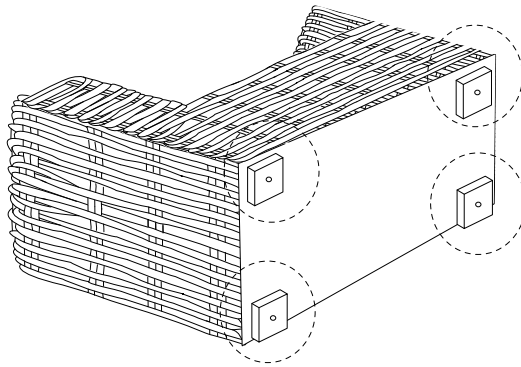
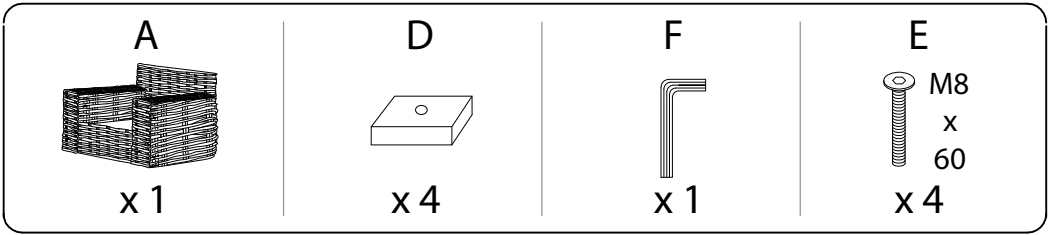

2

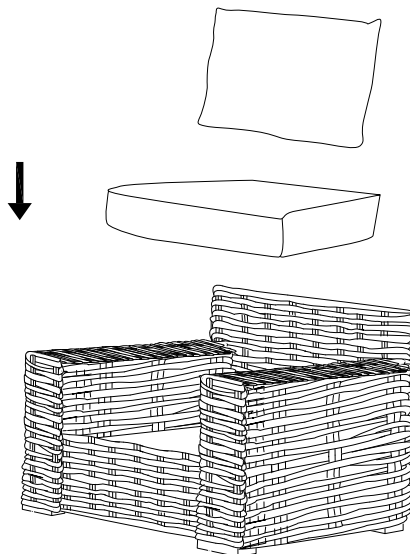
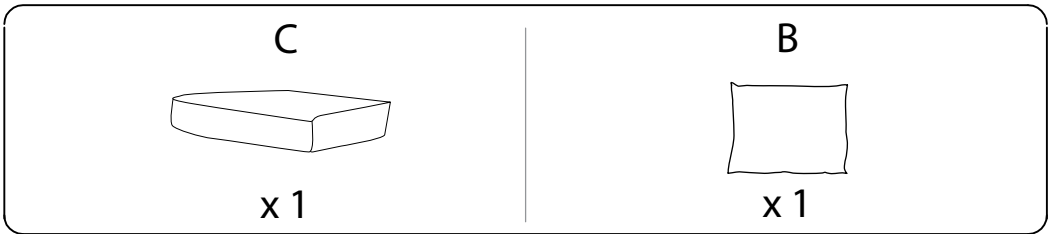

C

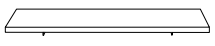
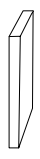
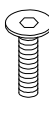
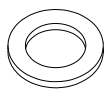
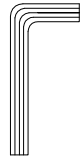
<p>A</p>  <p>x 1</p>	<p>B</p>  <p>x 2</p>	<p>C</p>  <p>M8 x 60</p> <p>x 6</p>	<p>D</p>  <p>x 6</p>	<p>E</p>  <p>x 1</p>
---	---	--	---	---



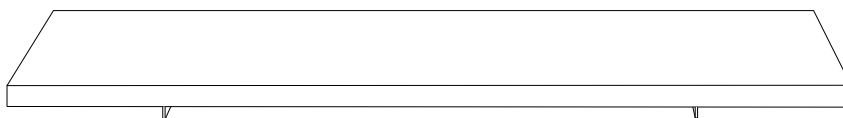

A x 1

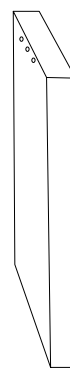

B x 2

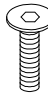

1

<p>A</p>  <p>x 1</p>	<p>B</p>  <p>x 2</p>	<p>C</p>  <p>M8 x 60</p> <p>x 6</p>	<p>D</p>  <p>x 6</p>	<p>E</p>  <p>x 1</p>
---	---	--	---	---

