

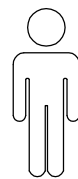









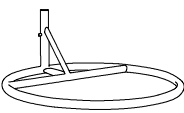

30'

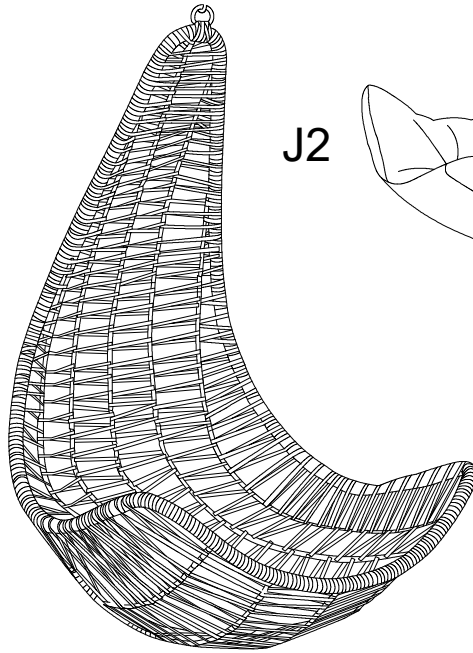
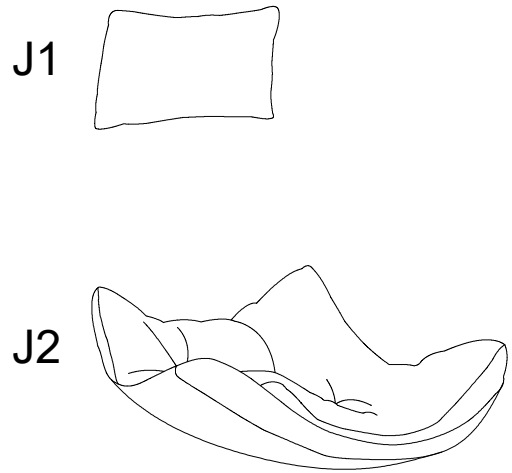
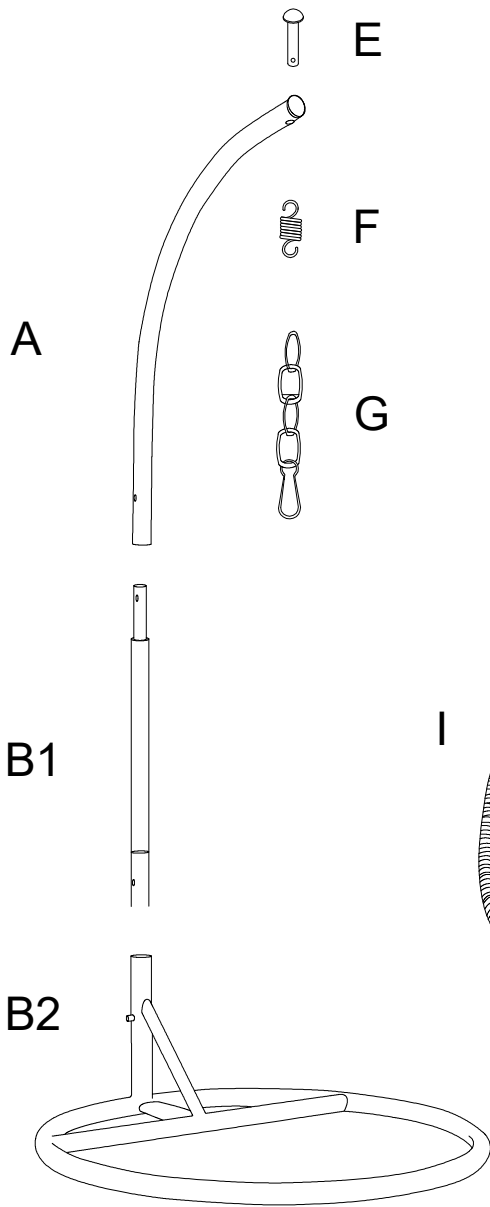

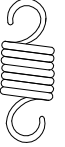
2

A	B1	B2	C	D	E
					
x 1	x 1	x 1	x 2	x 4	x 1

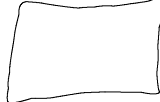

F	G	H	I	J1	J2
					
x 1	x 1	x 1	x 1	x 1	x 1

1

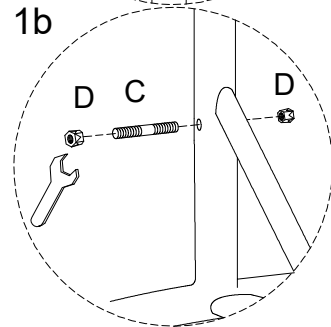
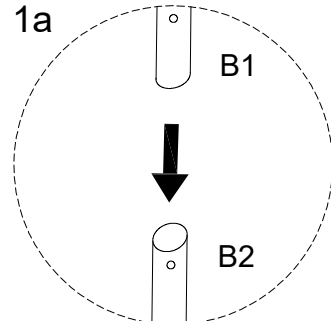
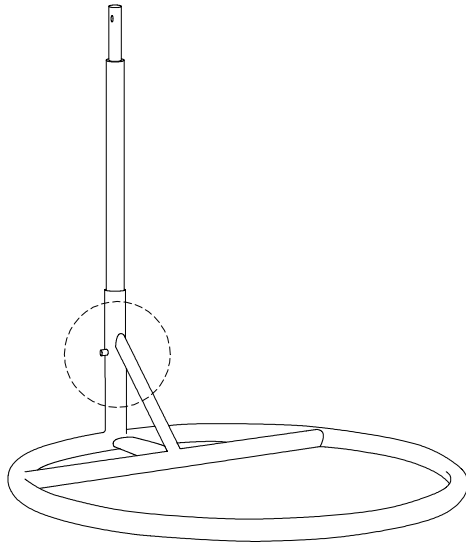
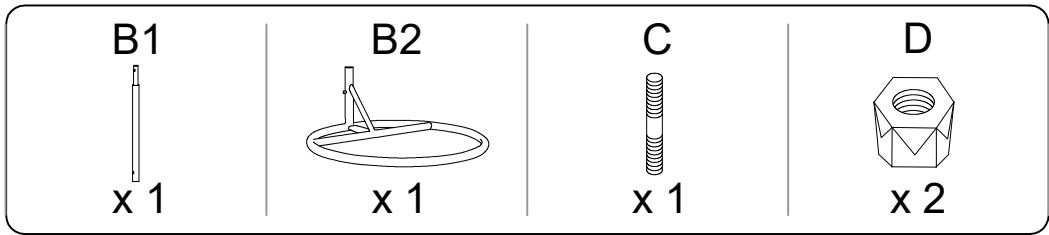

2

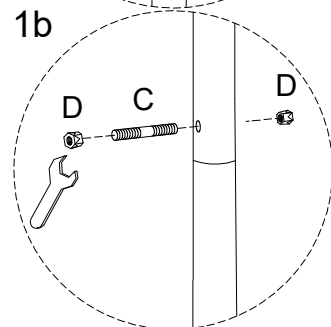
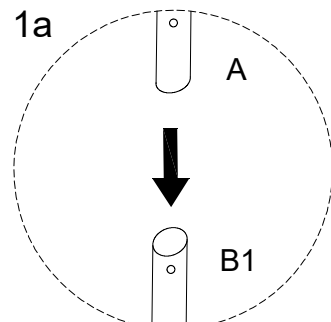
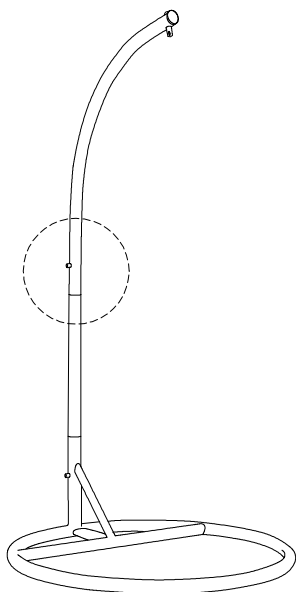
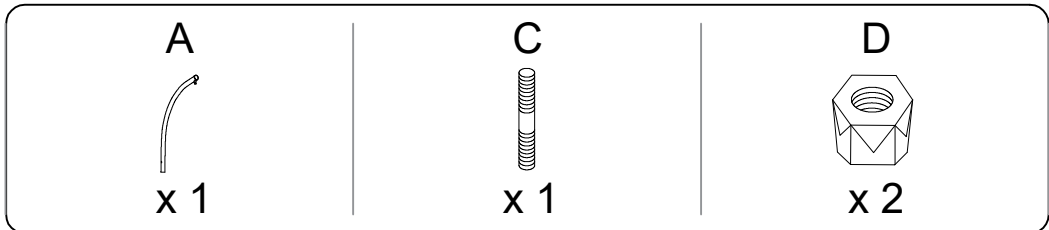

3

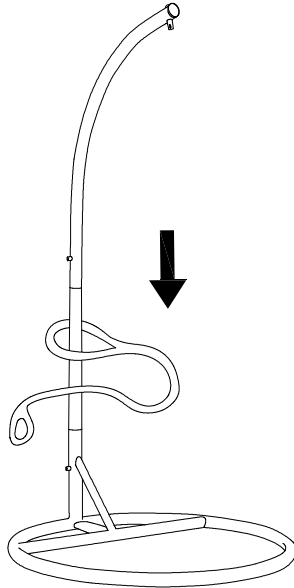
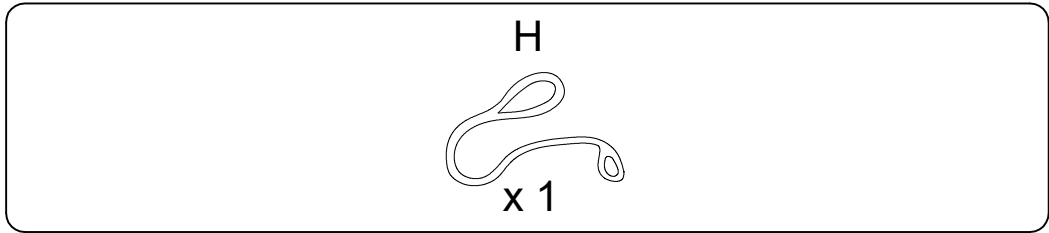

4

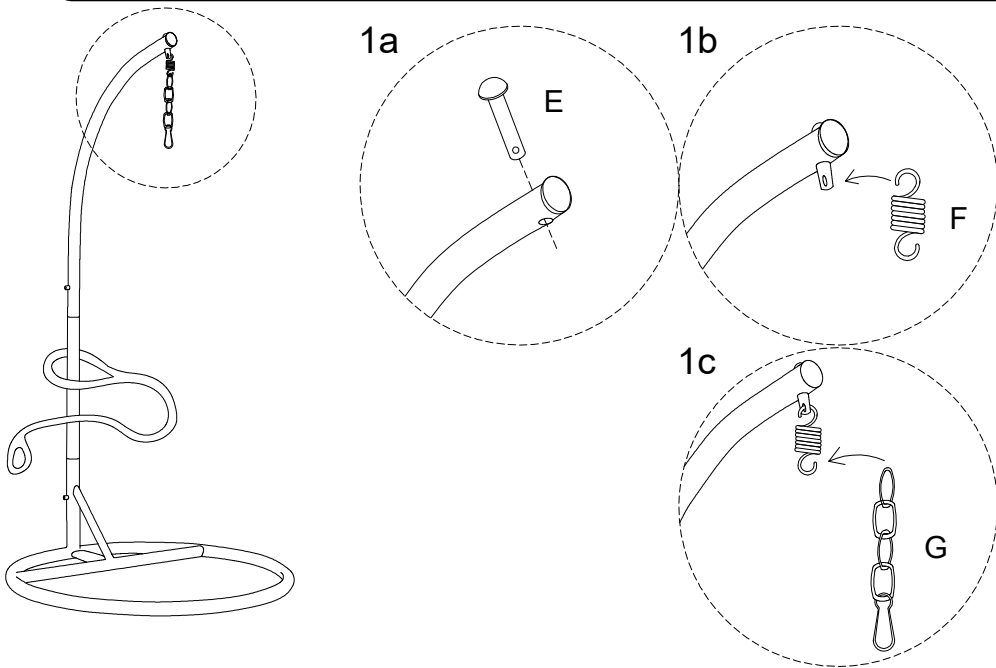
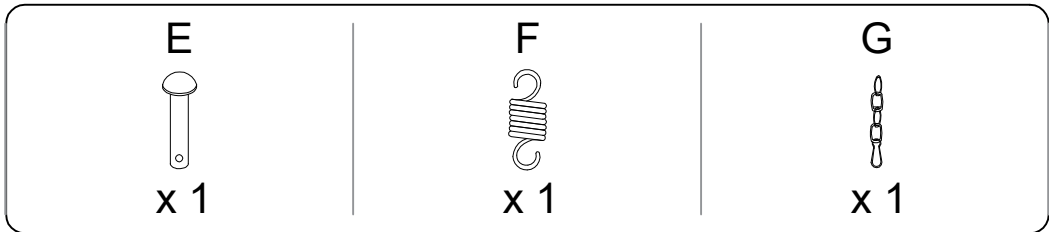

5

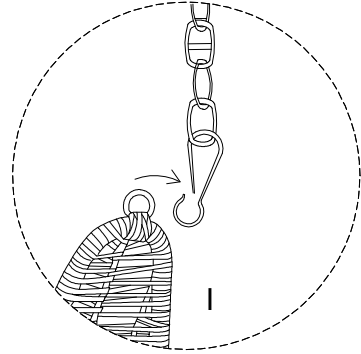
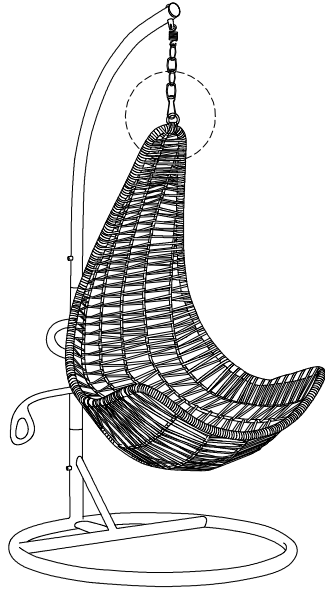

6

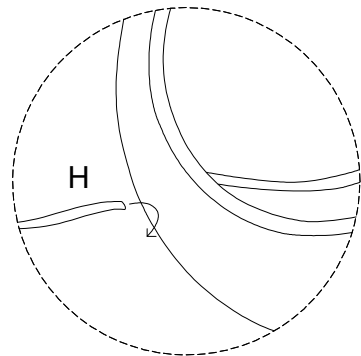
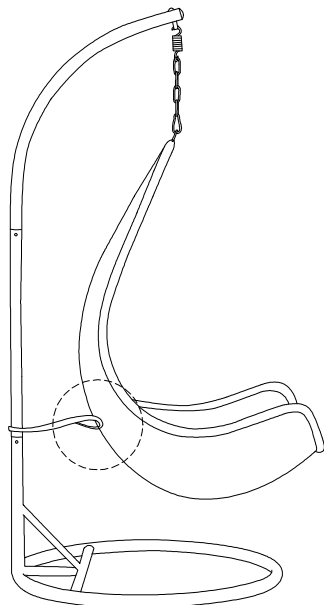
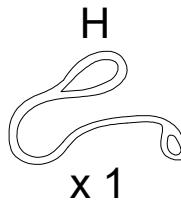

7

J1



x 1

J2



x 1

